

OMRON

Smart Sensors

ZX Series

Operation Manual

Smart Style!



OMRON Corporation

Cat. No. Z157-E1-02

Introduction

Thank you for purchasing an OMRON ZX-series Smart Sensor. We hope you will fully utilize this product and its performance for many years to come.

The ZX-series Smart Sensor is a laser product designed specifically as a sensing device. To ensure safety, read this manual carefully before using the Sensor. In addition, keep this manual in an easily accessible location for quick reference when needed.

READ AND UNDERSTAND THIS DOCUMENT

Please read and understand this document before using the products. Please consult your OMRON representative if you have any questions or comments.

WARRANTY

OMRON's exclusive warranty is that the products are free from defects in materials and workmanship for a period of one year (or other period if specified) from date of sale by OMRON.

OMRON MAKES NO WARRANTY OR REPRESENTATION, EXPRESS OR IMPLIED, REGARDING NON-INFRINGEMENT, MERCHANTABILITY, OR FITNESS FOR PARTICULAR PURPOSE OF THE PRODUCTS. ANY BUYER OR USER ACKNOWLEDGES THAT THE BUYER OR USER ALONE HAS DETERMINED THAT THE PRODUCTS WILL SUITABLY MEET THE REQUIREMENTS OF THEIR INTENDED USE. OMRON DISCLAIMS ALL OTHER WARRANTIES, EXPRESS OR IMPLIED.

LIMITATIONS OF LIABILITY

OMRON SHALL NOT BE RESPONSIBLE FOR SPECIAL, INDIRECT, OR CONSEQUENTIAL DAMAGES, LOSS OF PROFITS OR COMMERCIAL LOSS IN ANY WAY CONNECTED WITH THE PRODUCTS, WHETHER SUCH CLAIM IS BASED ON CONTRACT, WARRANTY, NEGLIGENCE, OR STRICT LIABILITY.

In no event shall responsibility of OMRON for any act exceed the individual price of the product on which liability is asserted.

IN NO EVENT SHALL OMRON BE RESPONSIBLE FOR WARRANTY, REPAIR, OR OTHER CLAIMS REGARDING THE PRODUCTS UNLESS OMRON'S ANALYSIS CONFIRMS THAT THE PRODUCTS WERE PROPERLY HANDLED, STORED, INSTALLED, AND MAINTAINED AND NOT SUBJECT TO CONTAMINATION, ABUSE, MISUSE, OR INAPPROPRIATE MODIFICATION OR REPAIR.

SUITABILITY FOR USE

THE PRODUCTS CONTAINED IN THIS DOCUMENT ARE NOT SAFETY RATED. THEY ARE NOT DESIGNED OR RATED FOR ENSURING SAFETY OF PERSONS, AND SHOULD NOT BE RELIED UPON AS A SAFETY COMPONENT OR PROTECTIVE DEVICE FOR SUCH PURPOSES. Please refer to separate catalogs for OMRON's safety rated products.

OMRON shall not be responsible for conformity with any standards, codes, or regulations that apply to the combination of products in the customer's application or use of the product.

At the customer's request, OMRON will provide applicable third party certification documents identifying ratings and limitations of use that apply to the products. This information by itself is not sufficient for a complete determination of the suitability of the products in combination with the end product, machine, system, or other application or use.

The following are some examples of applications for which particular attention must be given. This is not intended to be an exhaustive list of all possible uses of the products, nor is it intended to imply that the uses listed may be suitable for the products:

Outdoor use, uses involving potential chemical contamination or electrical interference, or conditions or uses not described in this document.

Nuclear energy control systems, combustion systems, railroad systems, aviation systems, medical equipment, amusement machines, vehicles, safety equipment, and installations subject to separate industry or government regulations.

Systems, machines, and equipment that could present a risk to life or property.

Please know and observe all prohibitions of use applicable to the products.
NEVER USE THE PRODUCTS FOR AN APPLICATION INVOLVING SERIOUS RISK TO LIFE OR PROPERTY WITHOUT ENSURING THAT THE SYSTEM AS A WHOLE HAS BEEN DESIGNED TO ADDRESS THE RISKS, AND THAT THE OMRON PRODUCT IS PROPERLY RATED AND INSTALLED FOR THE INTENDED USE WITHIN THE OVERALL EQUIPMENT OR SYSTEM.

PERFORMANCE DATA

Performance data given in this document is provided as a guide for the user in determining suitability and does not constitute a warranty. It may represent the result of OMRON's test conditions, and the users must correlate it to actual application requirements. Actual performance is subject to the OMRON Warranty and Limitations of Liability.

CHANGE IN SPECIFICATIONS

Product specifications and accessories may be changed at any time based on improvements and other reasons.

It is our practice to change model numbers when published ratings or features are changed, or when significant construction changes are made. However, some specifications of the product may be changed without any notice. When in doubt, special model numbers may be assigned to fix or establish key specifications for your application on your request. Please consult with your OMRON representative at any time to confirm actual specifications of purchased products.

DIMENSIONS AND WEIGHTS

Dimensions and weights are nominal and are not to be used for manufacturing purposes, even when tolerances are shown.

ERRORS AND OMISSIONS

The information in this document has been carefully checked and is believed to be accurate; however, no responsibility is assumed for clerical, typographical, or proofreading errors, or omissions.

PROGRAMMABLE PRODUCTS

OMRON shall not be responsible for the user's programming of a programmable product, or any consequence thereof.

COPYRIGHT AND COPY PERMISSION

This document shall not be copied for sales or promotions without permission.

This document is protected by copyright and is intended solely for use in conjunction with the product. Please notify us before copying or reproducing this document in any manner, for any other purpose. If copying or transmitting this document to another, please copy or transmit it in its entirety.

For Your Safety

- **Notation for Safety Information**

The following conventions are used to indicate and classify precautions in this manual. Always heed the information provided with them. Failure to heed precautions can result in injury to people or damage to property.



WARNING

Indicates a potentially hazardous situation which, if not avoided, will result in minor or moderate injury, or may result in serious injury or death. Additionally there may be significant property damage.



CAUTION

Indicates a potentially hazardous situation which, if not avoided, may result in minor or moderate injury, or in property damage.

Laser Safety

The ZX-LD□□, ZX-LD□□L, ZX-LD□□V, and ZX-LD□□VL Sensor Heads are Class 2 Laser Products according to EN60825-1 (IEC825-1) and Class II Laser Products according to FDA (21 CFR1040.10) (see note). The ZX-LT□□□ Sensor Heads are Class 1 and Class II Laser Products, respectively. The ZX Series is meant to be built into final system equipment. Pay special attention to the following precautions for the safe use of the product:

Note: Europe: Class 1 and Class 2 of EN60825-1: 1994 = IEC825-1: 1993
U.S.A.: Class I and Class II of FDA (21 CFR1040.10)

- (1) Use this product as specified in this operation manual. Otherwise, you may be exposed to hazardous laser radiation.
- (2) The ZX-series Smart Sensors radiate laser beams in the visible light range. Do not expose your eyes directly to the laser radiation. Ensure that the laser beam path is terminated during use. If a mirror or shiny surface is positioned in the laser beam path, ensure that the reflected beam path is also terminated. If the Unit must be used without terminating the laser beam path, position the laser beam path so that it is not at eye level.
- (3) To avoid exposure to hazardous laser radiation, do not displace nor remove the protective housing during operation, maintenance, and any other servicing.
- (4) The user should return the product to OMRON for all repair and servicing.
- (5) As for countries other than those of Europe and the U.S.A., observe the regulations and standards specified by each country.

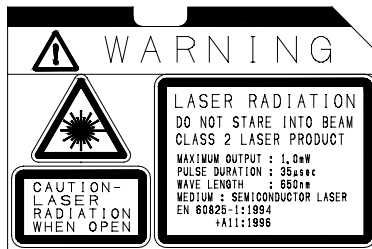

Requirements from Regulations and Standards

EN60825-1 “Safety of Laser Products, Equipment Classification, Requirements and User’s Guide”

• Summary of Manufacturer’s Requirements

Requirements; Sub-clause	Classification				
	Class 1	Class 2	Class 3A	Class 3B*	Class 4
Description of hazard class	Safe under reasonably foreseeable conditions	Low power; eye protection normally afforded by aversion responses	Same as Class 2. Direct intra-beam viewing with optical aids may be hazardous	Direct intra-beam viewing may be hazardous	High power; dif-fused reflection may be hazardous
Protective housing	Required for each laser product; limits access necessary for performance of functions of the products				
Safety interlock in protective housing	Designed to prevent removal of the panel until accessible emission values are below the AEL (see note 2) for the class assigned				
Remote control	Not required			Permits easy addition of external interlock in laser installation	
Key control	Not required			Laser inoperative when key is removed	
Emission warn-ing device	Not required			Gives audible or visible warning when laser is switched on or if capacitor bank of pulsed laser is being charged	
Attenuator	Not required			Gives means beside ON/OFF switch to temporarily block beam	
Location controls	Not required		Controls so located that there is no danger of exposure to AEL above Classes 1 or 2 when adjustments are made.		
Viewing optics	Emission from all viewing systems must be below Class 1 AEL’s as applicable				
Scanning	Scan failure shall not cause product to exceed its classification				
Class label	Required wording	Figures A and B and specified wording			
Aperture label	Not required			Specified wording required	
Service entry label	Required as appropriate to the class of accessible radiation				
Override interlock label	Required under certain conditions as appropriate to the class of laser used				
User information	Operation manuals must contain instructions for safe use				
Purchasing and service information	Promotion brochures must reproduce classification labels; service manuals must contain safety information				
Medical products	Special calibration instructions required			Special calibration instructions, means for measurement and target-indicator required	
Fibre optic	Cable service connections require tool to disconnect if disconnection breaks protective housing and permits access above Class 1				

*With respect to the requirements of remote interlock connector, key control, emission warning and attenuator, Class 3B laser products not exceeding five times the AEL of Class 2 in the wavelength range of 400 nm to 700 nm are to be treated as Class 3A laser products.

- Note 1.** The above table is intended to provide a convenient summary of requirements. See text of this standard for complete requirements.
- 2. AEL: Accessible Emission Limit**
 The maximum accessible emission level permitted within a particular class. For your reference, see ANSI Z136.1-1993, Section 2.

Symbol and border: black
 Background: yellow

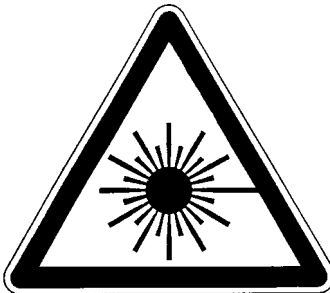

Figure A Warning label - Hazard symbol

Legend and border: black
 Background: yellow



Figure B Explanatory label

• FDA (Compliance Guide for Laser Products, 1985, according to 21 CFR1040.10)

Requirements	Class (see note 1)					
	I	Ila	II	IIla	IIlb	IV
Performance (all laser products)						
Protective housing	R (see note 2)	R (see note 2)	R (see note 2)	R (see note 2)	R (see note 2)	R (see note 2)
Safety interlock	R (see notes 3, 4)	R (see notes 3, 4)	R (see notes 3, 4)	R (see notes 3, 4)	R (see notes 3, 4)	R (see notes 3, 4)
Location of controls	N/A	R	R		R	R
Viewing optics	R	R	R	R	R	R
Scanning safeguard	R	R	R	R	R	R
Performance (laser systems)						

Laser Safety

Requirements	Class (see note 1)					
	I	Ila	II	IIla	IIlb	IV
Remote control connector	N/A	N/A	N/A	N/A	R	R
Key control	N/A	N/A	N/A	N/A	R	R
Emission indicator	N/A	N/A	R	R	R (See note 10.)	R (See note 10.)
Beam attenuator	N/A	N/A	R	R	R	R
Reset	N/A	N/A	N/A	N/A	N/A	R (See note 13.)
Performance (specific purpose products)						
Medical	S	S	S	S (See note 8.)	S (See note 8.)	S (See note 8.)
Surveying, leveling, alignment	S	S	S	S	NP	NP
Demonstration	S	S	S	S	S (See note 11.)	S (See note 11.)
Labeling (all laser products)						
Certification & identification	R	R	R	R	R	R
Protective housing	D (See note 5.)	D (See Note 5.)	D (See note 5.)	D (See note 5.)	D (See note 5.)	D (See note 5.)
Aperture	N/A	N/A	R	R	R	R
Class warning	N/A	R (See note 6.)	R (See note 7.)	R (See note 9.)	R (See note 12.)	R (See note 12.)
Information (all laser products)						
User information	R	R	R	R	R	R
Product literature	N/A	R	R	R	R	R
Service information	R	R	R	R	R	R

Abbreviations:

R: Required.

N/A: Not applicable.

S: Requirements: Same as for other products of that Class.

Also see footnotes.

NP: Not permitted.

D: Depends on level of interior radiation.

Footnotes:

1. Based on highest level accessible during operation.
2. Required wherever & whenever human access to laser radiation above Class I limits is not needed for product to perform its function.
3. Required for protective housings opened during operation or maintenance, if human access thus gained is not always necessary when housing is open.
4. Interlock requirements vary according to Class of internal radiation.
5. Wording depends on level & wavelength of laser radiation within protective housing.

6. Warning statement label.
7. CAUTION logotype.
8. Requires means to measure level of laser radiation intended to irradiate the body.
9. CAUTION if 2.5 mW cm² or less, DANGER if greater than 2.5 mW cm⁻².
10. Delay required between indication & emission.
11. Variance required for Class IIb or IV demonstration laser products and light shows.
12. DANGER logotype.
13. Required after August 20, 1986.

Use Precautions

• EN60825-1

Requirements; Sub-clause	Classification				
	Class 1	Class 2	Class 3A	Class 3B*	Class 4
Remote interlock	Not required		Connect to room or door circuits		
Key control	Not required		Remove key when not in use		
Beam attenuator	Not required		When in use prevents inadvertent exposure		
Emission indicator device	Not required		Indicates laser is energized		
Warning signs	Not required		Follow precautions on warning signs		
Beam path	Not required	Terminate beam at end of useful length			
Specular reflection	No requirements			Prevent unintentional reflections	
Eye protection	No requirements		Required if engineering and administrative procedures not practicable and MPE exceeded		
Protective clothing	No requirements			Sometimes required	Specific requirements
Training	No requirements		Required for all operator and maintenance personnel		

*With respect to the requirements of remote interlock connector, key control, beam attenuator, and emission indicator, Class 3B laser products not exceeding five times the AEL of Class 2 in the wavelength range of 400 nm to 700 nm are to be treated as Class 3A laser products.

Note: This table is intended to provide a convenient summary of requirements. See text of this standard for complete precautions.

• ANSI Z136.1:1993 “American National Standard for the Safe Use of Lasers” Control Measures for the Four Laser Classes

Control measures	Classification					
Engineering Controls	1	2a	2	3a	3b	4
Protective Housing (4.3.1)	X	X	X	X	X	X
Without Protective Housing (4.3.1.1)	LSO (see note 2) shall establish Alternate Controls					

Laser Safety

Control measures	Classification					
	☆	☆	☆	☆	X	X
Interlocks on Protective Housing (4.3.2)	☆	☆	☆	☆	X	X
Service Access Panel (4.3.3)	☆	☆	☆	☆	X	X
Key Control (4.3.4)	---	---	---	---	•	X
Viewing Portals (4.3.5.1)	---	---	MPE	MPE	MPE	MPE
Collecting Optics (4.3.5.2)	MPE	MPE	MPE	MPE	MPE	MPE
Totally Open Beam Path (4.3.6.1)	---	---	---	---	X NHZ	X NHZ
Limited Open Beam Path (4.3.6.2)	---	---	---	---	X NHZ	X NHZ
Enclosed Beam Path (4.3.6.3)	None is required if 4.3.1 and 4.3.2 fulfilled					
Remote Interlock Connector (4.3.7)	---	---	---	---	•	X
Beam Stop or Attenuator (4.3.8)	---	---	---	---	•	X
Activation Warning Systems (4.3.9)	---	---	---	---	•	X
Emission Delay (4.3.9.1)	---	---	---	---	---	X
Indoor Laser Controlled Area (4.3.10)	---	---	---	---	X NHZ	X NHZ
Class 3b Laser Controlled Area (4.3.10.1)	---	---	---	---	X	---
Class 4 Laser Controlled Area (4.3.10.2)	---	---	---	---	---	X
Laser Outdoor Controls (4.3.11)	---	---	---	---	X NHZ	X NHZ
Laser in Navigable Airspace (4.3.11.2)	---	---	---	•	•	•
Temporary Laser Controlled Area (4.3.12)	☆ MPE	☆ MPE	☆ MPE	☆ MPE	---	---
Remote Firing & Monitoring (4.3.13)	---	---	---	---	---	•
Labels (4.3.14 and 4.7)	X	X	X	X	X	X
Area Posting (4.3.15)	---	---	---	•	X NHZ	X NHZ
Administrative & Procedural Controls	1	2a	2	3a	3b	4
Standard Operating Procedures (4.4.1)	---	---	---	---	•	X
Output Emission Limitations (4.4.2)	---	---	---	LSO Determination		
Education and Training (4.4.3)	---	---	•	•	X	X
Authorized Personnel (4.4.4)	---	---	---	---	X	X
Alignment Procedures (4.4.5)	---	---	X	X	X	X
Protective Equipment (4.4.6)	---	---	---	---	•	X
Spectator (4.4.7)	---	---	---	---	•	X
Service Personnel (4.4.8)	☆ MPE	☆ MPE	☆ MPE	☆ MPE	X	X
Demonstration with General Public (4.5.1)	MPE †	---	X	X	X	X
Laser Optical Fiber Systems (4.5.2)	MPE	MPE	MPE	MPE	X	X
Laser Robotic Installations (4.5.3)	---	---	---	---	X NHZ	X NHZ

Control measures	Classification					
Eye Protection (4.6.2)	---	---	---	---	• MPE	X MPE
Protective Windows (4.6.3)	---	---	---	---	X NHZ	X NHZ
Protective Barriers and Curtains (4.6.4)	---	---	---	---	•	•
Skin Protection (4.6.5)	---	---	---	---	X MPE	X MPE
Other Protective Equipment (4.6.5)	Use may be required					
Warning Signs and Labels (4.7) (Design Requirements)	---	---	•	•	X NHZ	X NHZ
Service and Repairs (4.8)	LSO Determination					
Modification of Laser Systems (4.9)	LSO Determination					

Note 1. LEGEND

- X: Shall
- : Should
- : No requirement
- ☆: Shall if enclosed Class 3b or Class 4
- MPE: Shall if MPE is exceeded
- NHZ: Nominal Hazard Zone analysis required
- †: Applicable only to UV and IR Lasers (4.5.1.2)

2. LSO: Laser Safety Officer

An individual shall be designated the Laser Safety Officer with the authority and responsibility to monitor and enforce the control of laser hazards, and to effect the knowledgeable evaluation and control of laser hazards. For your reference, see ANSI Z136.1-1993, Section 1.3.

Laser Product Classifications

• EN

Class	Description
Class 1	Lasers which are safe under reasonably foreseeable conditions of operation.
Class 2	Lasers emitting visible radiation in the wavelength range from 400 nm to 700 nm. Eye protection is normally afforded by aversion responses including the blink reflex.
Class 3A	Lasers which are safe for viewing with the unaided eye. For laser emitting in the wavelength range from 400 nm to 700 nm, protection is afforded by aversion responses including the blink reflex. For other wavelengths the hazard to the unaided eye is no greater than for Class 1. Direct intrabeam viewing of Class 3A lasers with optical aides (e.g., binoculars, telescopes, microscopes) may be hazardous.
Class 3B	Direct intrabeam viewing of these lasers is always hazardous. Viewing diffuse reflections is normally safe (see note).
Class 4	Lasers which are also capable of producing hazardous diffuse reflections. They may cause skin injuries and could also constitute a fire hazard. Their use requires extreme caution.

Note: Conditions for safe viewing of diffuse reflections for Class 3B visible lasers are: minimum viewing distance of 13 cm between screen and cornea and a maximum viewing time of 10 s. Other viewing conditions require a comparison of the diffuse reflection exposure with the MPE.

Comparison of Classifications between FDA and ANSI

Class	FDA definition	ANSI description
Class I/1	Limits applicable to devices that have emissions in the ultraviolet, visible, and infrared spectra, and limits below which biological hazards have not been established.	A Class 1 laser is considered to be incapable of producing damaging radiation levels during operation and maintenance and is, therefore, exempt from any control measures or other forms of surveillance.
Class IIa/2a	Limits applicable to products whose visible emission does not exceed Class I limits for emission durations of 1,000 seconds or less and are not intended for viewing.	Class 2 lasers are divided into two subclasses, 2 and 2a. A Class 2 laser emits in the visible portion of the spectrum (0.4 to 0.7 μm) and eye protection is normally afforded by the aversion response including the blink reflex.
Class II/2	Limits applicable to products that have emissions in the visible spectrum (400 to 710 nm) for emission durations in excess of 0.25 second, providing that emissions for other durations and/or wavelengths do not exceed the Class I limits. Class II products are considered hazardous for direct long-term ocular exposure.	
Class IIIa/3a	Limits to products that have emissions in the visible spectrum and that have beams where the total collectable radiant power does not exceed 5 milliwatts.	Class 3 lasers are divided into two subclasses, 3a and 3b. A Class 3 laser may be hazardous under direct and specular reflection viewing conditions, but the diffuse reflection is usually not a hazard.
Class IIIb/3b	Limits applicable to devices that emit in the ultraviolet, visible, and infrared spectra. Class IIIb products include laser systems ranging from 5 to 500 milliwatts in the visible spectrum. Class IIIb emission levels are ocular hazards for direct exposure throughout the range of the Class, and skin hazards at the higher levels of the Class.	
Class IV/4	Exceeding the limits of Class IIIb and are a hazard for scattered reflection as well as for direct exposure.	A Class 4 laser is a hazard to the eye or skin from the direct beam and sometimes from a diffuse reflection and also can be a fire hazard. Class 4 lasers may also produce laser-generated air contaminants and hazardous plasma radiation.

Label Indications

- EN

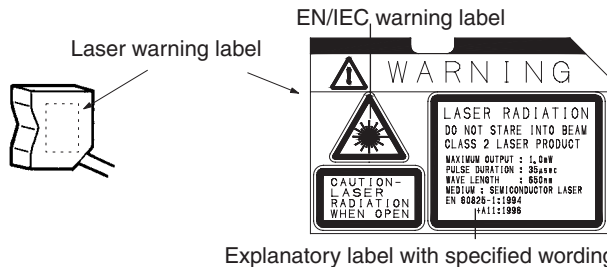

Note: Use of controls, adjustments, or procedures other than those specified herein may result in hazardous radiation exposure.

•FDA

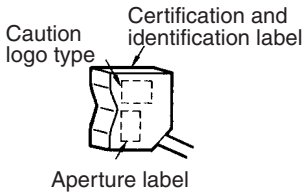

Aperture Label

AVOID
EXPOSURE
Laser radiation
is emitted from
this aperture

Class II Caution logo type

CAUTION

LASER RADIATION
DO NOT STARE INTO BEAM

PEAK POWER 4W
PULSE DURATION 4s
BEAM LENGTH 4m

CLASS II LASER PRODUCT

Certification and Identification Label

This laser product complies with
21 CFR 1040.10 and 1040.11.
OMRON Corporation
Shiokoji Horikawa, Shimogyo-ku,
Kyoto 600-8630 JAPAN
Place of manufacture:
AYABE Factory, OMRON Corp.
Manufactured in

Note: Use of controls, adjustments, or procedures other than those specified here-in may result in hazardous radiation exposure.

Precautions

■ Ratings and Performance

- (1) Conform to the specified ratings and performance.

Reference » Refer to "6-1 Ratings/Specifications"

- Do not impose voltage exceeding the rated voltage, otherwise the Sensor may be damaged.
 - When supplying power to the Sensor, make sure that the polarity of the power is correct, otherwise, the Sensor may be damaged. Do not connect to an AC power supply.
 - Do not short-circuit the load for the open collector output, otherwise the Sensor may be damaged.
- (2) Do not disconnect the connector connecting the Sensor Head and the controller while power is being supplied, otherwise the Sensor may be damaged.
 - (3) Allow a warm-up period of approximately 10 minutes after turning ON the power supply.
 - (4) Objects of certain materials or shapes may not be detectable, or the detection accuracy may not be sufficiently high. These include materials that are transparent or have extremely low reflectivity, and objects that are smaller than the Sensor's spot diameter or have extreme curvature or inclination.

■ Power Supply and Wiring

- (1) Prior to turning ON the power supply after wiring is completed, check to make sure that the power supply is correct, that there are no mistaken connections, e.g., connections that would short-circuit the load, and that the load current is appropriate. Incorrect wiring may result in damage to the Sensor or Unit.
- (2) The total length of the Sensor cable or Amplifier cable must be 10 m or less. Use an ZX-XC□A Extension Cable (order separately) if required to extend the cable from the Sensor. Use a shielded cable to extend the Amplifier cable. The shielded cable must be the same as that of the Amplifier cable.
- (3) Do not lay a power supply cable for the ZX together with high-voltage lines or power lines to prevent interference, damage, and malfunction.
- (4) When using a commercially available switching regulator, ground the FG (frame ground) terminal.
- (5) If the power supply line is subject to surges, connect a surge absorber that meets the conditions of the usage environment.
- (6) When using a Calculating Unit, connect the corresponding linear ground of the Amplifier Unit.

■ Environment

- (1) Do not use the Sensor in strong electromagnetic fields or in an environment where the operation of the Sensor is subject to the reflection of intense light (such as other laser beams or electric arc-welding machines.)
- (2) Do not operate the Sensor in the following locations:
 - Locations subject to strong vibration.

- Locations subject to direct sunlight or near heating equipment.
- Locations subject to high humidity.
- Locations where the Sensor would accumulate dust, dirt, metallic powder, etc.
- Locations subject to corrosive or flammable gases.
- Locations subject to exposure to organic solvents, water, oil, etc.
- Locations subject to strong electromagnetic or electrical fields.
- Locations subject to rapid changes in temperature.
- Locations subject to freezing.

■ Maintenance

(1) Always turn OFF the power supply before adjusting or removing the Sensor Head.

(2) Cleaning

Do not use thinners, benzene, acetone, or kerosene for cleaning.

If dust or oil adheres to the filter on the front of the Sensor Head, use the following procedure to clean.

- Use a blower brush (used to clean camera lenses) to blow large dust particles from the surface. Do not blow the dust away with your mouth.
- Use a soft cloth (for lenses) with a small amount of alcohol to remove the remaining dust. Do not use a scrubbing action when cleaning because scratches on the filter could result in Sensor inaccuracy.

■ Compatibility

All Sensor Heads and Amplifier Units are compatible. Different Sensor Heads may be purchased at a later date and used with existing Amplifier Units.

■ Controlling Mutual Interference

Mutual interference can be prevented when using two Sensor Heads together, by connecting the ZX-CAL Calculating Unit between the two Amplifier Units. However, this effect cannot be attained if the laser beam of one Sensor Head is received when the other Sensor Head is approaching saturation. When considering the use of the ZX-CAL Calculating Unit to control mutual interference, confirm the operation with actual Units in advance.

■ Applicable standards

- EN61326-1
- Electromagnetic environment: Industrial electromagnetic environment (EN/IEC 61326-1 Table 2)
- There may be cases that current output or voltage output fluctuate within ± 3 times of resolution when a sensor is experienced electromagnetic interference.

Table of Contents

For Your Safety	i
Laser Safety.....	ii
Precautions.....	xi
SECTION 1 Before Use.....	1
1-1 Names of Sensor Parts	2
1-2 External Amplifier Unit I/O.....	5
1-3 I/O Circuit Diagrams	6
1-4 Connections	8
1-5 Installation	11
1-6 Settings Required before Application.....	15
SECTION 2 Outline of Operation	19
2-1 Part Names and Functions	20
2-2 Outline of Key Operations.....	21
2-3 Procedures for Reflective Sensor Heads.....	22
2-4 Procedures for Through-beam Sensor Heads	24
2-5 Outline of Functions	26
SECTION 3 Descriptions of Functions.....	29
3-1 ZX-L Series	31
3-2 Hardware Functions.....	34
3-3 Reflective Sensor Heads: RUN Mode Functions	38
3-4 Reflective Sensor Heads: T Mode Functions	41
3-5 Reflective Sensor Heads: FUN Mode Functions.....	44
3-6 Through-beam Sensor Heads: RUN Mode Functions	71
3-7 Through-beam Sensor Heads: T Mode Functions.....	75
3-8 Through-beam Sensor Heads: FUN Mode Functions	79
SECTION 4 Operating Procedures	107
4-1 Display Operations	108
4-2 Initial Display	111
4-3 RUN Mode	112
4-4 T (Threshold) Mode.....	118
4-5 FUN (Function) Mode	124
SECTION 5 Troubleshooting.....	141
5-1 Error Displays.....	142
5-2 Setting Problems.....	144
SECTION 6 Specifications and Dimensions	147
6-1 Ratings/Specifications	148
6-2 Dimensions	156
Revision History.....	166

Visual Aids

The following icons are used to aid you in finding specific types of information.



Indicates useful information.

Note: Indicates precautions to be observed during operation.

Reference »» Indicates section numbers where related information can be found.

Displayed Form of Alphabet Letters

- The letters of the alphabet are displayed digitally in the following forms.

A	b	c	d	E	F	G	h	I	J
Ā	ḃ	ċ	ḍ	Ē	Ƒ	Ĝ	ĥ	Ī	Ĵ
K	L	m	n	o	P	q	r	S	t
Ƙ	Ĺ	ṁ	ṅ	ŏ	Ƒ	ƚ	ŕ	Ƒ	ƚ
U	v	w	X	Y	Z				
Ū	ṽ	Ẃ	Ẅ	Ẇ	Ẑ				



SECTION 1 Before Use

This section describes preparations that are necessary prior to switching ON the power supply, such as installation, wiring, and connections.

1-1 Names of Sensor Parts	2
1-1-1 Reflective Sensor Heads	2
1-1-2 Through-beam Sensor Heads	3
1-1-3 Amplifier Units	4
1-1-4 Calculating Unit	4
1-2 External Amplifier Unit I/O	5
1-3 I/O Circuit Diagrams	6
1-3-1 NPN Amplifier Unit: ZX-LDA11	6
1-3-2 PNP Amplifier Unit: ZX-LDA41	7
1-4 Connections	8
1-4-1 Sensor Head and Amplifier Unit	8
1-4-2 Connecting Cable and Sensor Head	8
1-4-3 Extension Cables	9
1-4-4 Amplifier Units and Calculating Unit	9
1-5 Installation	11
1-5-1 Reflective Sensor Heads	11
1-5-2 Through-beam Sensor Heads	12
1-5-3 Amplifier Unit	14
1-6 Settings Required before Application	15
1-6-1 Auto-scale	15
1-6-2 Reference Incident Level	16
1-6-3 Linear Output	17

1-1 Names of Sensor Parts

1-1-1 Reflective Sensor Heads

A Reflective Sensor Head is used for displacement measurements.

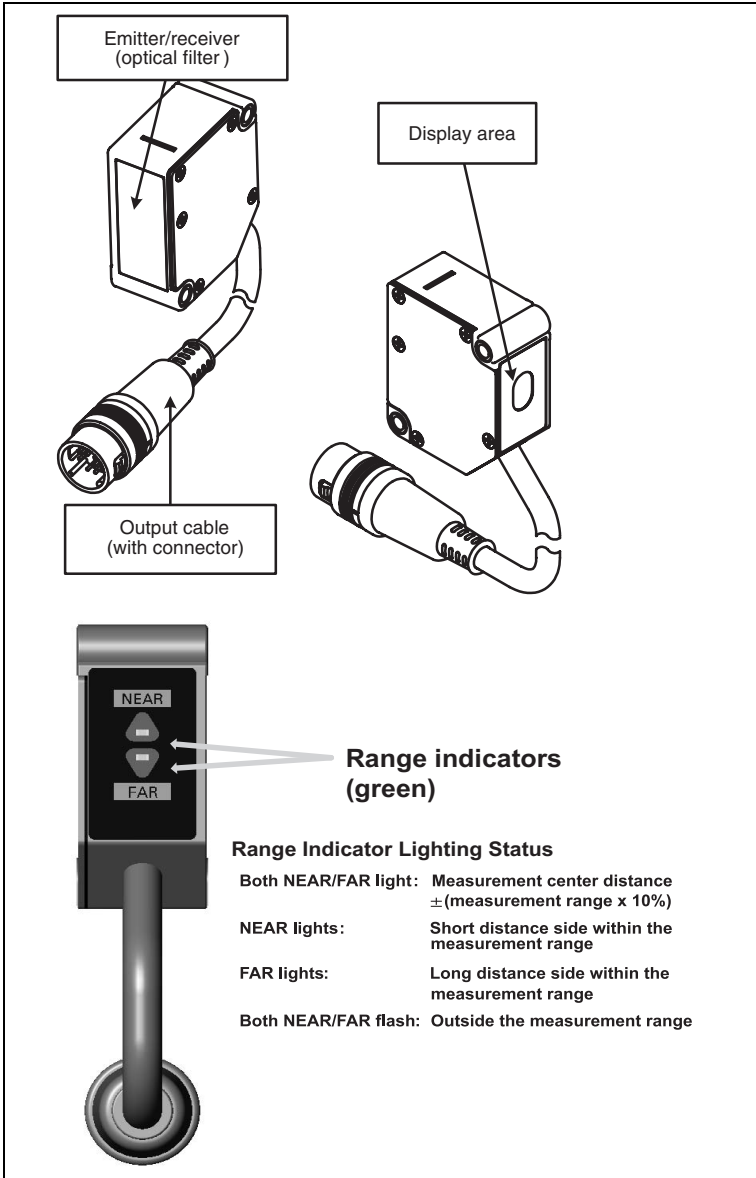

1-1-2 Through-beam Sensor Heads

A Through-beam Sensor Head is used for length measurements and consists of two main parts: An Emitter and a Receiver.

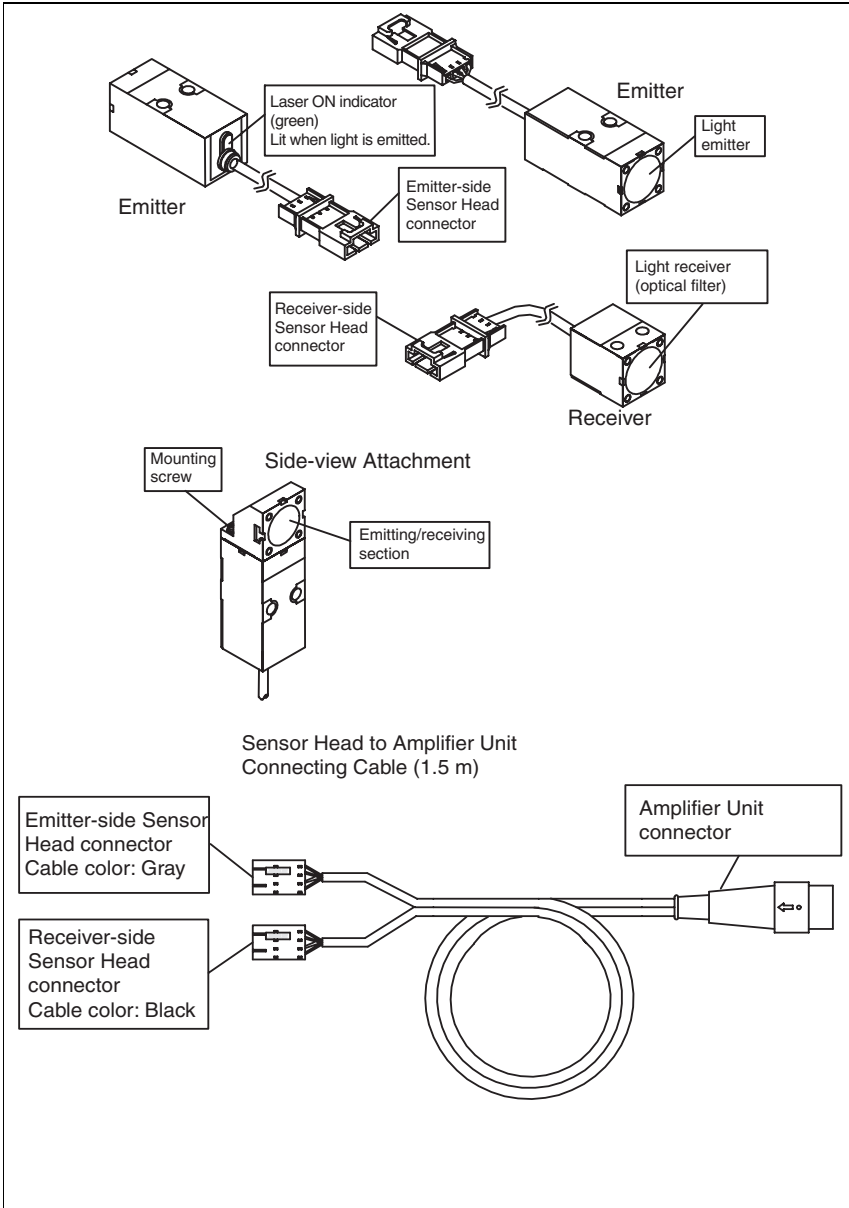

1-1-3 Amplifier Units

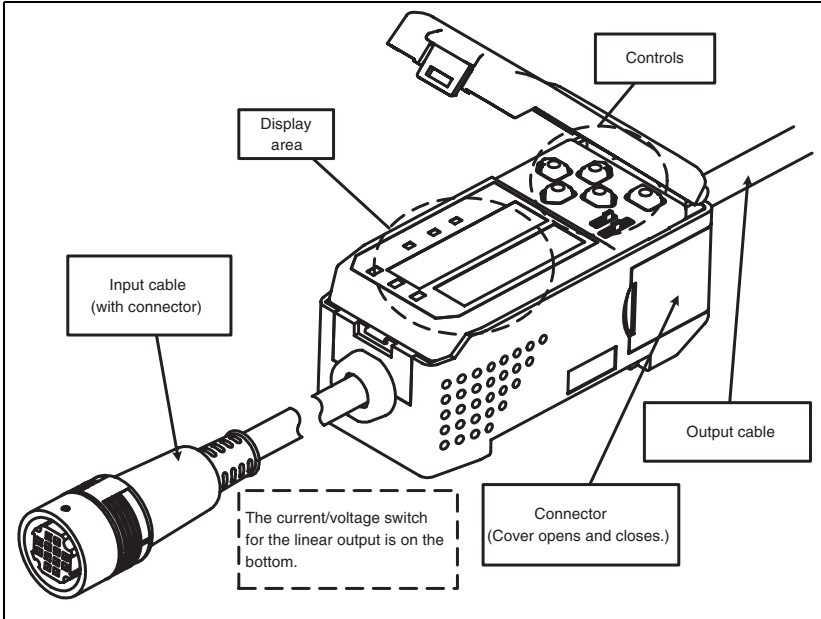

1-1-4 Calculating Unit

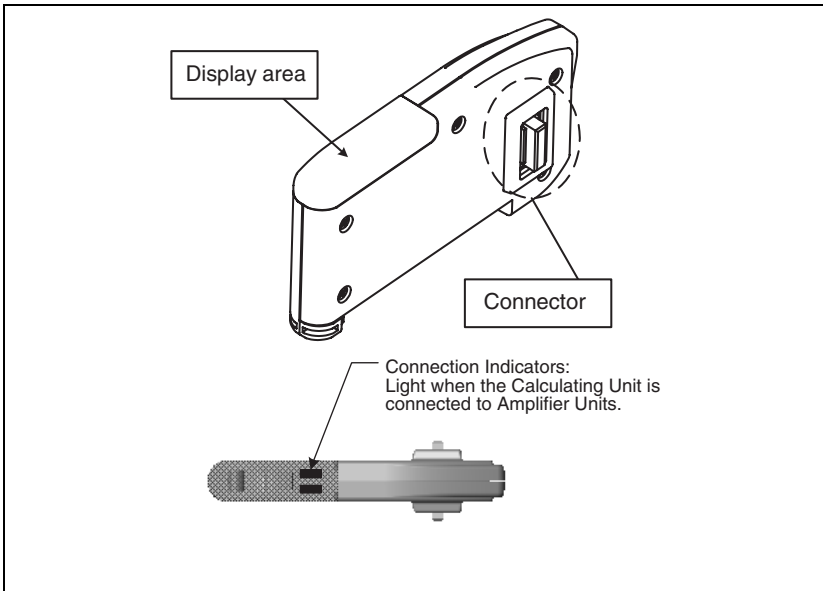

1-2 External Amplifier Unit I/O

The following functions are allocated to the external I/O lines.

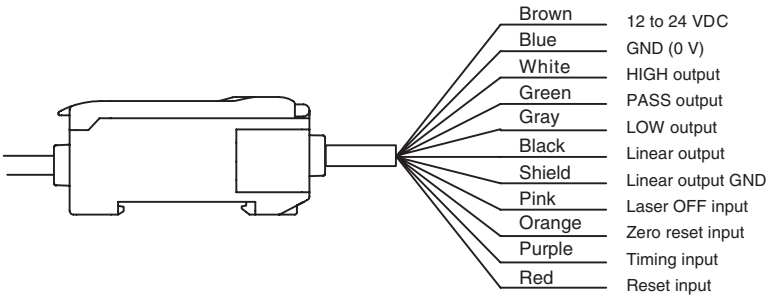

Reference » Refer to **3-2 Hardware Functions** for I/O functions.

- Note**
1. Use a separate stabilized power supply for the Amplifier Unit, particularly when high resolution is required.
 2. Wire the Unit correctly. Incorrect wiring may result in damage to the Unit. (Do not allow the I/O lines, particularly the linear output, to come into contact with other lines.)
 3. Use the 0-V ground line (blue line) for the power supply and use the shield wire (linear output ground) together with the linear output (black line) for linear output. Each of these grounds must be used for the designed purpose. When not using the linear output, connect the linear output ground to the 0-V ground line.

1-3 I/O Circuit Diagrams

1-3-1 NPN Amplifier Unit: ZX-LDA11

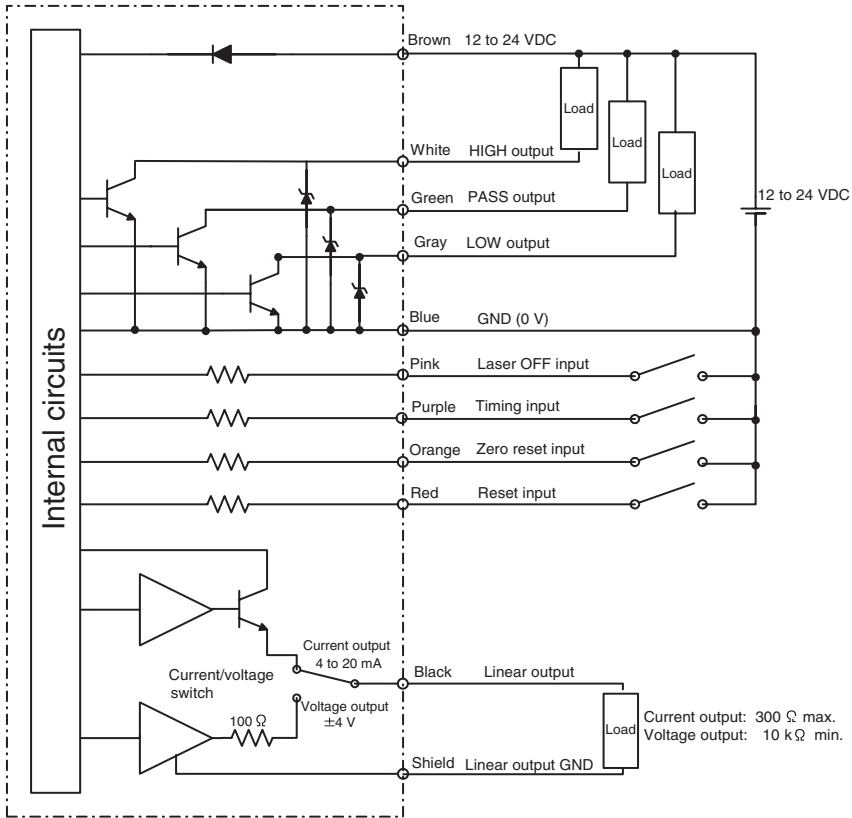

1-3-2 PNP Amplifier Unit: ZX-LDA41

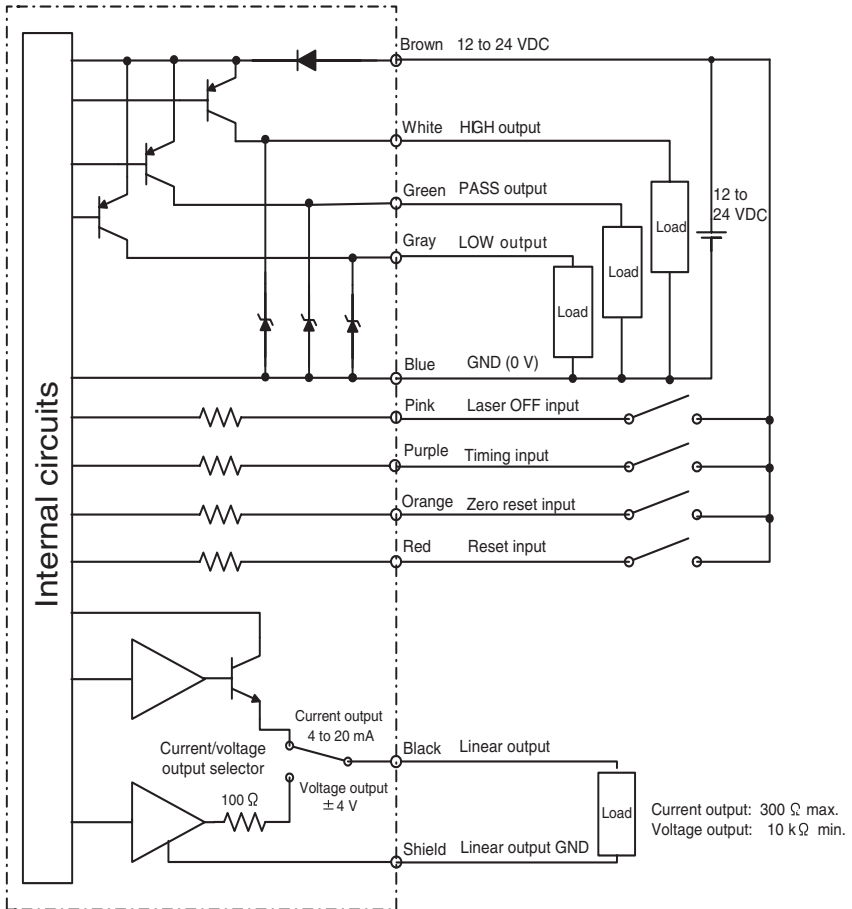

1-4 Connections

1-4-1 Sensor Head and Amplifier Unit

1. Insert the output cable connector of the Sensor Head into the input cable connector of the Amplifier Unit until the connector ring locks into place.
2. When disconnecting the Sensor Head, hold the connector ring and Amplifier Unit connector and pull them straight out.



CAUTION

- Do not pull only on the connector ring, because the input cable of the Amplifier Unit may be damaged.
- Do not touch the pins or contacts inside the connectors.

1-4-2 Connecting Cable and Sensor Head

This procedure is necessary for Through-beam Sensor Heads only.

1. Insert the emitter-side and receiver-side connectors from the Sensor Head into both the emitter-side and receiver-side connectors on the Connecting Cable until they lock in place. Connect the gray cables for the Emitter and the black cables for the Receiver.
2. When disconnecting the Sensor Head, detach the emitter-side and receiver-side connectors on the Connecting Cable from the emitter-side and receiver-side connectors on the Sensor Head cables and then pull them straight out.



CAUTION

- Do not touch the pins or contacts inside the connector.
- Never allow the connectors to be subjected to electrostatic charges.

1-4-3 Extension Cables

When extending Sensor Head and Amplifier Unit cables, use the following special cables (order separately).

- 1-m Cable: ZX-XC1A
- 4-m Cable: ZX-XC4A
- 8-m Cable: ZX-XC8A
- 9-m Cable: ZX-XC9A (for use with Reflective Sensors only)

Connect the Extension Cable between the Connecting Cable and the Amplifier Unit.

Note: Never use two or more Extension Cables to extend the cable length.

1-4-4 Amplifier Units and Calculating Unit

1. Open the connector covers on the Amplifier Units by lifting and slide them open.

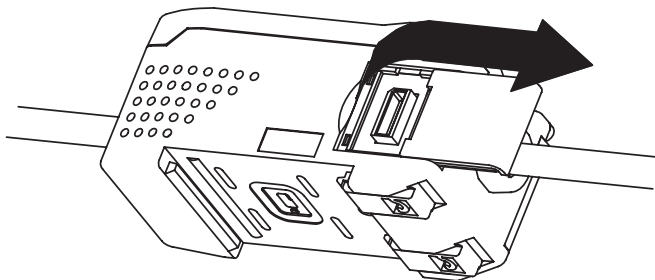

2. Mount the front section of the Calculating Unit to the DIN Track.
3. Slide the Calculating Unit on the DIN Track until the Calculating Unit connector connects securely to the connector on the first Amplifier Unit. The connectors should click into place.

- Slide the other Amplifier Unit on the DIN Track until the Calculating Unit connector connects securely to the Amplifier Unit connector. The connectors should click into place.

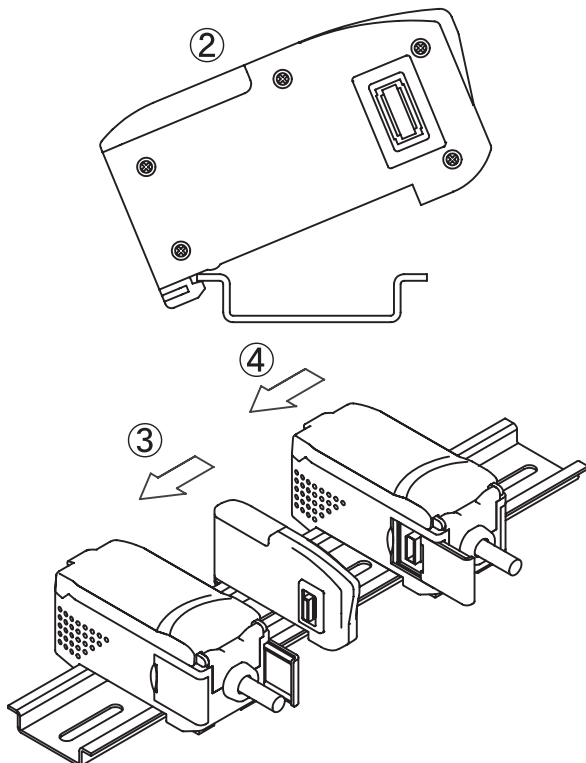

- Note**
- Connect the connectors only after mounting the Units to the DIN Track.
 - Use an PFP-M End Plate when necessary to prevent the Amplifier Units from moving (e.g., as a result of vibration).

1-5 Installation

1-5-1 Reflective Sensor Heads

Install the Sensor Head using the screws provided with it.

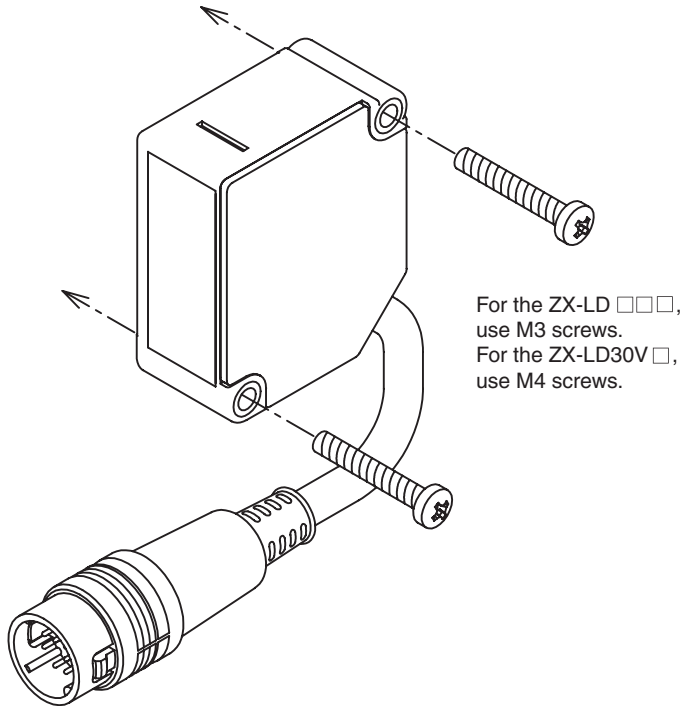

Reference » Mounting Hole Size

Refer to **6-2-1 Reflective Sensor Heads**.

- Note**
1. Secure the connector so that it is not subjected to vibration or shock.
 2. Do not touch the optical filter on the Sensor Head. Fingerprints or other contamination on the filter will interfere with correct Sensor operation. If the filter is touched by mistake, clean it by wiping it gently with a soft clean cloth.

1-5-2 Through-beam Sensor Heads

Installation

- The Emitter and Receiver must be installed in the same direction to align the laser beam.

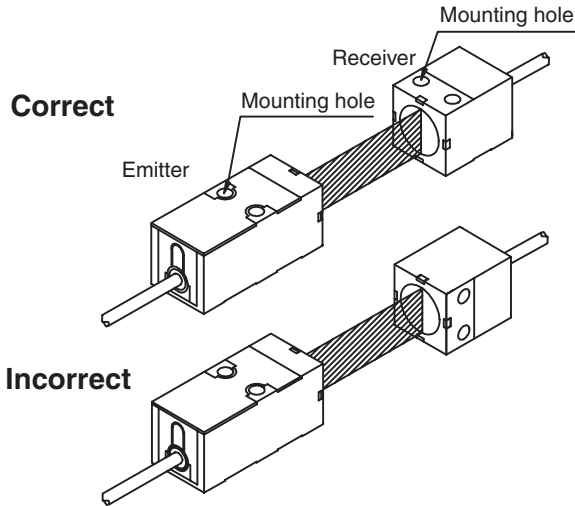

- Tighten the screws to a torque of 0.3 N·m or less.

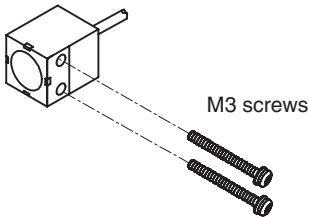

ZX-LT001/LT005

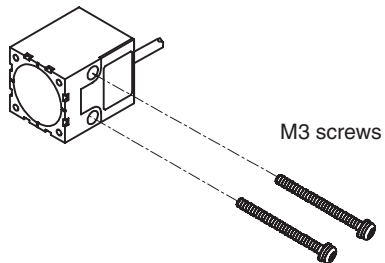

ZX-LT010

Optical Axis Adjustment

- Attach the optical axis adjustment seal provided with the Sensor Head to the front of the Emitter. Adjust the laser beam radiated from the Emitter so that it is aligned with the center of the cross on the seal. Always remove the seal after completing the adjustment.

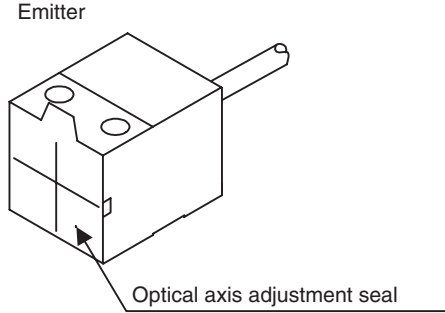

If you need more accurate adjustment of the optical axis, adjust it to maximize the value displayed on the Amplifier Unit.

Note: Do not touch the surface of the Emitter and Receiver on the Sensor Head. Fingerprints or other contamination on the surface will interfere with correct Sensor operation. If the surface is touched by mistake, clean it by wiping it gently with a soft clean cloth.

Mounting the Side-view Attachment

- The ZX-XF□2 Side-view Attachment (order separately) can be mounted to the Emitter, to the Receiver, or to both.
- To mount the Side-view Attachment, use the M2 screws provided and tighten them to a torque of 0.08 N·m or less.

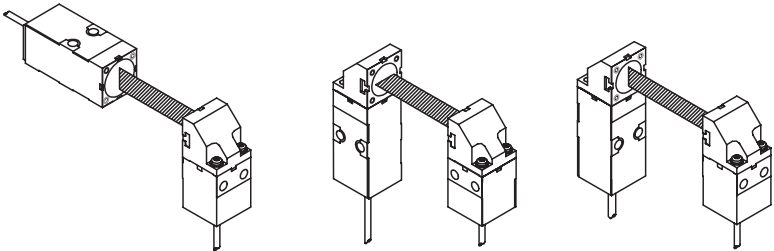

- Note**
1. Use the same tightening torque for the left and right screws. The laser beam may be distorted if the tightening torque is not the same.
 2. If the screws are tightened at a stronger torque than specified, the screw holes may be damaged. Use the specified torque. Be sure to use the M2 screws provided with the Side-view Attachment when mounting.
 3. When using the Side-view Attachment, adjust the optical axis after mounting the Attachment. Be sure to set the reference incident level after adjusting the optical axis.

1-5-3 Amplifier Unit

Mounting

1. Mount the front of the Unit to the DIN Track.
2. Press the rear of the Unit onto the DIN Track.

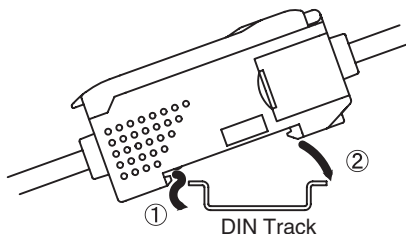

Removing

1. Press the Unit toward the front.
2. Lift the front of the Unit.

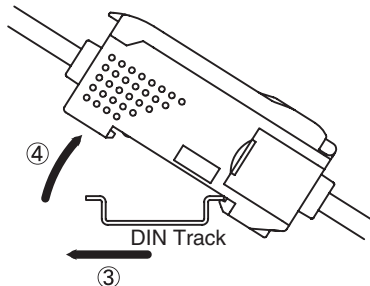

Note: Always mount the front of the Unit first. Mounting strength may decrease if mounting is performed in the reverse order.

1-6 Settings Required before Application

These settings are required only for a Through-beam Sensor Head.

The settings for the auto-scale, reference incident level, and linear output are required before application.

Perform the settings in the following order:

1-6-1 Auto-scale



1-6-2 Reference Incident Level



1-6-3 Linear Output



The auto-scale function can be used only for a Through-beam Sensor Head.

1-6-1 Auto-scale

Select either millimeters or a percentage for the unit on the main display, and select whether the incident level or the intercepted amount is displayed.

For the default settings, the incident level is displayed as a percentage.

1. Display Unit

Select a percentage or mm to display the incident level on the main display.

2. Incident Level or Intercepted Amount

Select the incident level or the intercepted amount to use for the display and the linear output.

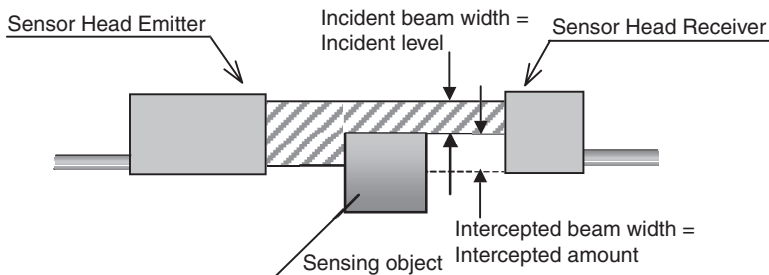

To measure the incident level, select -L.

To measure the intercepted amount, select -d.

3. Confirmation

Select both the display unit and either the incident level or the intercepted amount, and then press the ENT Key to confirm the settings. An example is shown below for measuring the incident level in millimeters.

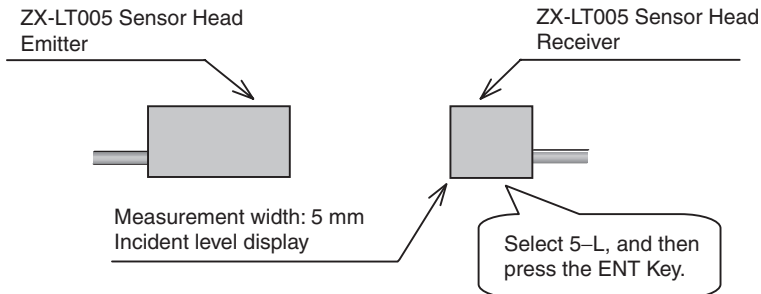



Reference »» For details, refer to **3-8-1 Auto-scaling** and **4-5-13 Auto-scale Settings**.

1-6-2 Reference Incident Level

When the Sensor Head is mounted for the first time, set the reference incident level after adjusting the optical axis.

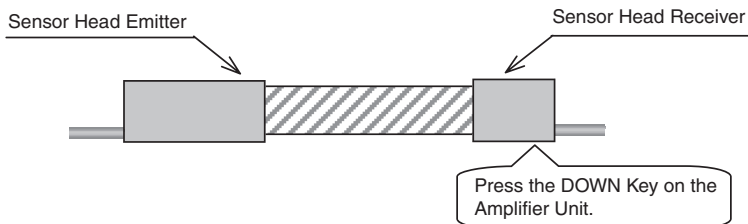
Reset the reference incident level whenever the position of the Sensor Head is changed.



Adjust the optical axis in RUN Mode so that none of the laser beam is intercepted, and then press the DOWN Key () for 3 seconds or longer.

Reference »» For details, refer to **3-6-2 Reference Incident Level Setting Function** and **4-3-3 Setting the Reference Incident Level**.

1-6-3 Linear Output

The default linear output settings are listed in the following table. These settings are set at the factory and also after initializing the settings.

Default linear output setting		Operation after setting reference incident level		
Voltage output	± 4 V	Incident level display	None of beam intercepted	4 V
			Entire beam intercepted	-4 V
		Intercepted amount display	None of beam intercepted	-4 V
			Entire beam intercepted	4 V
Current output	4 to 20 mA	Incident level display	None of beam intercepted	20 mA
			Entire beam intercepted	4 mA
		Intercepted amount display	None of beam intercepted	4 mA
			Entire beam intercepted	20 mA

Use the monitor focus function when setting the output voltage to 0 to 5 V or 1 to 5 V instead of ± 4 V.

Example: Setting Linear Output to 0 to 5 V

1. Set the mode switch to FUN.



RUN T FUN

2. Use the LEFT/RIGHT Keys to display **SPcL**.

SPcL
SEt

3. Use the UP/DOWN Keys to change **cLoSE** to **SEt**, and then press the ENT Key to confirm the selection.
4. Use the LEFT/RIGHT Keys to display **FocUS**.

5. Perform the following steps to set the linear output.

Monitor focus



■  Press the ENT Key to select the voltage output.

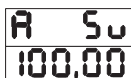

 Use UP/DOWN/LEFT/RIGHT Keys to set the focus value of the first point to 5 V at 100%.

■  Press the ENT Key to move to the monitor focus for the second point .



 Use UP/DOWN/LEFT/RIGHT Keys to set the focus value of the second point to 0 V at 0%.

■  Press the ENT Key to complete the monitor focus setting.

Monitor focus calculations will be performed.

 OK





End

SECTION 2 Outline of Operation

This section describes the overall flow of operation.

2-1 Part Names and Functions	20
2-2 Outline of Key Operations	21
2-3 Procedures for Reflective Sensor Heads	22
2-3-1 Positioning and Setting Threshold Values.....	22
2-3-2 Setting Various Functions	22
2-4 Procedures for Through-beam Sensor Heads	24
2-4-1 Positioning and Setting Threshold Values.....	24
2-4-2 Setting Various Functions	24
2-5 Outline of Functions	26
2-5-1 RUN Mode Displays	26
2-5-2 T Mode	26
2-5-3 FUN Mode Displays	26

2-1 Part Names and Functions

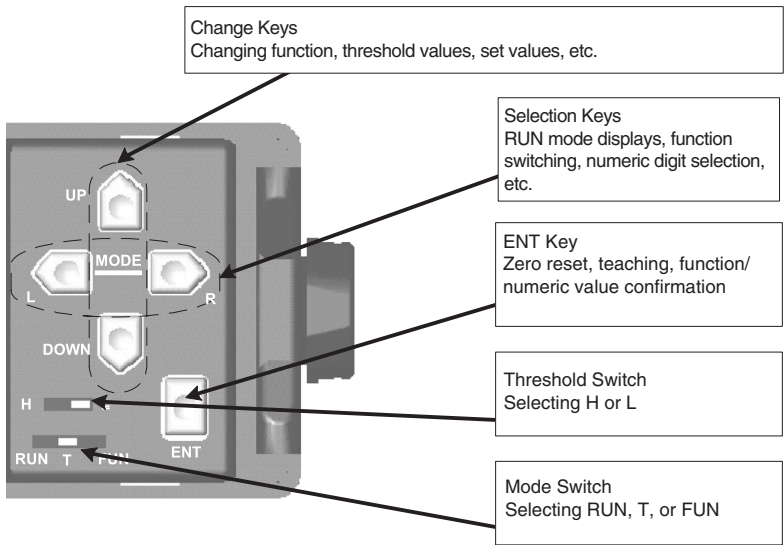
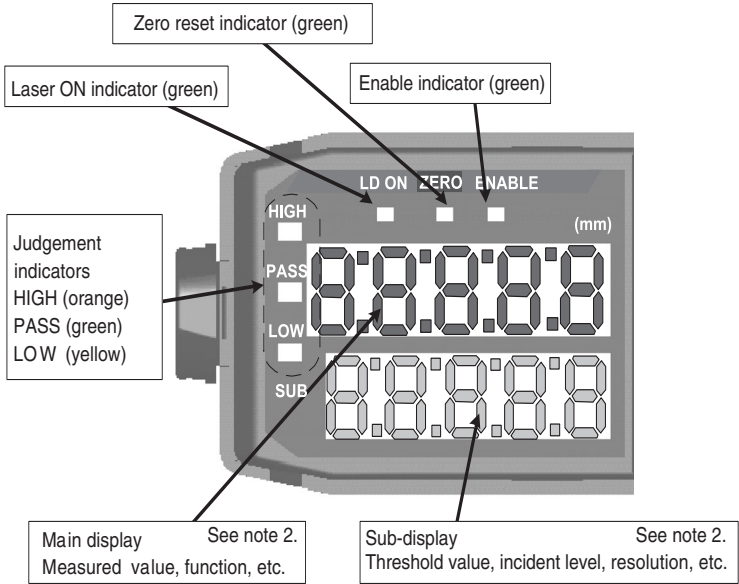

- Note**
1. The current/voltage switch for the linear output is on the bottom of the Amplifier Unit.
 2. The information displayed on the main display and sub-display is reversed if Reverse Mode is enabled.

2-2 Outline of Key Operations

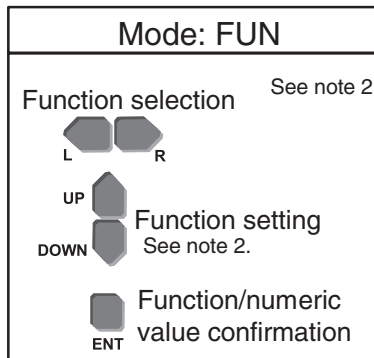
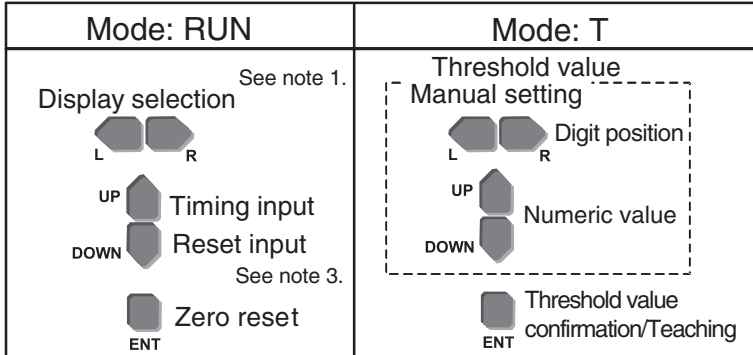

- Note**
1. Refer to 2-5-1 RUN Mode Displays for details.
 2. Refer to 2-5-3 FUN Mode Displays for function details.
 3. The DOWN Key is also used to input the reference incident level setting when a Through-beam Sensor Head is used.

2-3 Procedures for Reflective Sensor Heads

2-3-1 Positioning and Setting Threshold Values

Manual Setting

- · · · · Reference » *3-4-2 Inputting Threshold Values Directly*

Automatic Setting

- **Workpiece surface positioning:**
 - · · · · Reference » *Position Teaching in 3-4-1 Teaching*
- **Unknown size workpiece judgement:**
 - · · · · Reference » *Two-point Teaching in 3-4-1 Teaching*
- **Judging workpiece with uneven surfaces, warped workpieces, or moving workpieces:**
 - · · · · Reference » *Automatic Teaching in 3-4-1 Teaching*

2-3-2 Setting Various Functions

- **Changing the display value:**
 - · · · · Reference » *3-5-1 Scaling*
- **Changing response speed or increasing resolution:**
 - · · · · Reference » *3-5-2 Number of Samples to Average*
- **Changing positioning accuracy when operating and releasing:**
 - · · · · Reference » *3-5-3 Hysteresis Setting*
- **Holding value during measurement:**
 - · · · · Reference » *3-5-4 Hold Functions*
- **Using OFF-delay timer:**
 - · · · · Reference » *3-5-5 Timer*
- **Operation requiring two Sensor Heads:**
 - · · · · Reference » *3-5-6 Two-sensor Operation*
- **Resetting default status:**
 - · · · · Reference » *3-5-7 Initializing Settings*
- **Changing the output current or voltage range:**
 - · · · · Reference » *Special Functions (Set)*
3-5-8 Monitor Focus Function
- **Detecting the optical level:**
 - · · · · Reference » *Special Functions (Set)*
3-5-9 Intensity Mode

- **Detecting minute changes:**
 - · · · · **Reference** » Special Functions (Fun)
3-5-10 Differentiation Function
- **Reversing display order:**
 - · · · · **Reference** » Special Functions (disp)
3-5-11 Display Reverse Function
- **Minimizing the current consumption of the Amplifier Unit:**
 - · · · · **Reference** » Special Functions (disp)
3-5-12 ECO Display Function
- **Changing the number of digits on the display:**
 - · · · · **Reference** » Special Functions (disp)
3-5-13 Limiting the Number of Display Digits
- **Setting status when not measuring:**
 - · · · · **Reference** » Special Functions (Etc)
3-5-14 Setting for Non-measurement
- **Setting workpiece measurement to zero every time:**
 - · · · · **Reference** » Special Functions (Etc)
3-5-15 Zero Reset Memory Function
- **Setting reception sensitivity (automatic switching or fixed):**
 - · · · · **Reference** » Special Functions (Etc)
3-5-16 Gain Switch

2-4 Procedures for Through-beam Sensor Heads

2-4-1 Positioning and Setting Threshold Values

Manual Setting

Reference » *3-7-2 Inputting Threshold Values Directly*

Automatic Setting

- **Workpiece surface positioning:**
 Reference » *Position Teaching in 3-7-1 Teaching*
- **Unknown size workpiece judgement:**
 Reference » *Two-point Teaching in 3-7-1 Teaching*
- **Judging workpiece with uneven surfaces, warped workpieces, or moving workpieces:**
 Reference » *Automatic Teaching in 3-7-1 Teaching*

2-4-2 Setting Various Functions

- **Changing the incident level to any value:**
 Reference » *3-8-1 Auto-scaling*
- **Changing the display value:**
 Reference » *3-8-2 Scaling*
- **Changing the response speed or increasing resolution:**
 Reference » *3-8-3 Number of Samples to Average*
- **Changing positioning accuracy when operating and releasing:**
 Reference » *3-8-4 Hysteresis Setting*
- **Holding value during measurement:**
 Reference » *3-8-5 Hold Functions*
- **Using OFF-delay timer:**
 Reference » *3-8-6 Timer*
- **Operation requiring two Sensor Heads.**
 Reference » *3-8-7 Two-sensor Operation*
- **Resetting default status:**
 Reference » *3-8-8 Initializing Settings*

- **Changing output current or voltage range:**
 - · · · · **Reference** » Special Functions (Set)
3-8-9 Monitor Focus Function

- **Detecting minute changes:**
 - · · · · **Reference** » Special Functions (Fun)
3-8-10 Differentiation Function

- **Reversing display order:**
 - · · · · **Reference** » Special Functions (disp)
3-8-11 Display Reverse Function

- **Minimizing current consumption of the Amplifier Unit:**
 - · · · · **Reference** » Special Functions (disp)
3-8-12 ECO Display Function

- **Changing the number of digits on the display:**
 - · · · · **Reference** » Special Functions (disp)
3-8-13 Limiting the Number of Display Digits

- **Setting status when not measuring:**
 - · · · · **Reference** » Special Functions (Etc)
3-8-14 Setting for Non-measurement

- **Resetting workpiece measurement to zero every time:**
 - · · · · **Reference** » Special Functions (Etc)
3-8-15 Zero Reset Memory Function

- **Setting reception sensitivity (automatic switching or fixed):**
 - · · · · **Reference** » Special Functions (Etc)
3-8-16 Gain Switch

2-5 Outline of Functions

2-5-1 RUN Mode Displays

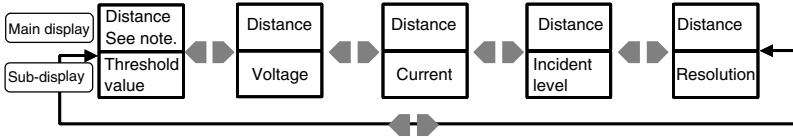

Note: The incident level is displayed in Intensity Mode (9999 max.).

2-5-2 T Mode

- Direct threshold value input
- Position teaching
- Two-point teaching
- Automatic teaching

2-5-3 FUN Mode Displays

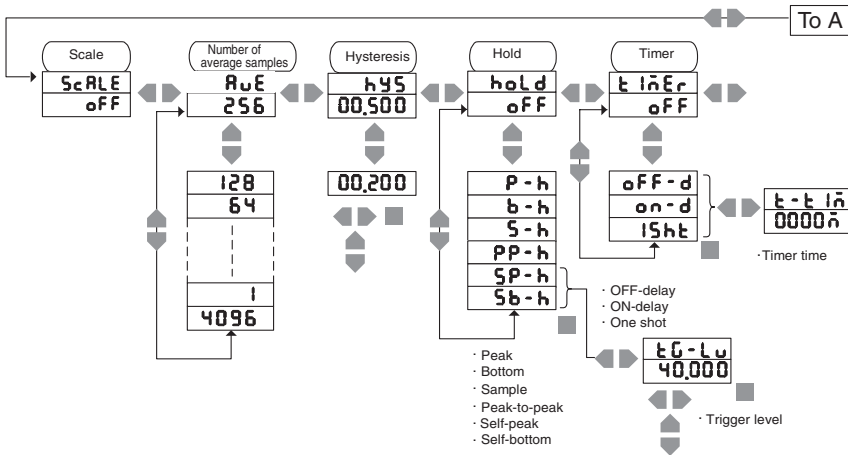

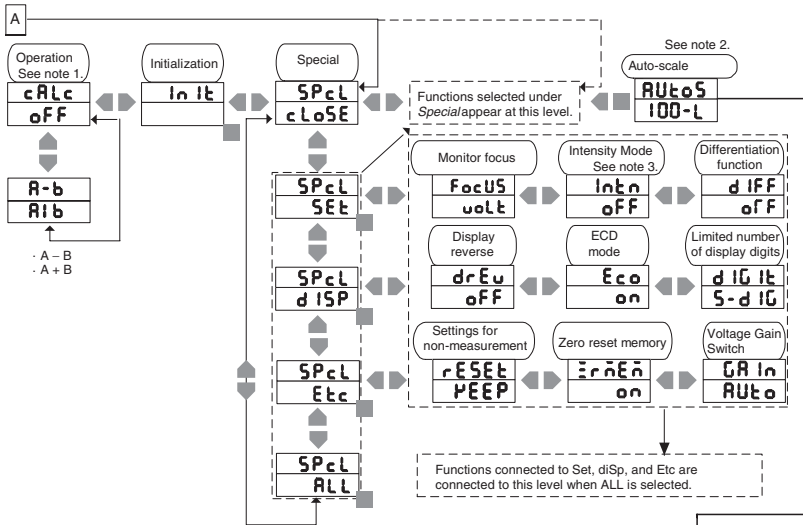

- Note 1: Appears only when two Sensor Heads are connected.
- Note 2: Appears only when a Through-beam Sensor Head is used.
- Note 3: Appears only when a Reflective Sensor Head is used.

Memo

SECTION 3 Descriptions of Functions

This section describes the functions that can be set.

3-1 ZX-L Series	31
3-1-1 ZX-L Series Outline	32
3-1-2 Sensor Heads	32
3-1-3 Amplifier Units	32
3-1-4 Calculating Unit	32
3-1-5 Channel Numbers of Amplifier Units	33
3-2 Hardware Functions	34
3-2-1 Inputs	34
3-2-2 Outputs	35
3-2-3 Performance	37
3-3 Reflective Sensor Heads: RUN Mode Functions	38
3-3-1 Sub-display Changes	38
3-3-2 Zero Reset/Release	38
3-4 Reflective Sensor Heads: T Mode Functions	41
3-4-1 Teaching	41
3-4-2 Inputting Threshold Values Directly	43
3-5 Reflective Sensor Heads: FUN Mode Functions	44
3-5-1 Scaling	44
3-5-2 Number of Samples to Average	51
3-5-3 Hysteresis Setting	52
3-5-4 Hold Functions	52
3-5-5 Timer	61
3-5-6 Two-sensor Operation	63
3-5-7 Initializing Settings	64
3-5-8 Monitor Focus Function	65
3-5-9 Intensity Mode	68
3-5-10 Differentiation Function	68
3-5-11 Display Reverse Function	69

3-5-12	ECO Display Function	69
3-5-13	Limiting the Number of Display Digits.....	69
3-5-14	Setting for Non-measurement.....	69
3-5-15	Zero Reset Memory Function	70
3-5-16	Gain Switch.....	70
3-5-17	Key Lock Function	70
3-6	Through-beam Sensor Heads: RUN Mode Functions.....	71
3-6-1	Sub-display Changes.....	71
3-6-2	Reference Incident Level Setting Function	72
3-6-3	Zero Reset/Release.....	72
3-7	Through-beam Sensor Heads: T Mode Functions	75
3-7-1	Teaching.....	75
3-7-2	Inputting Threshold Values Directly	78
3-8	Through-beam Sensor Heads: FUN Mode Functions	79
3-8-1	Auto-scaling	79
3-8-2	Scaling	80
3-8-3	Number of Samples to Average.....	87
3-8-4	Hysteresis Setting.....	88
3-8-5	Hold Functions.....	89
3-8-6	Timer.....	97
3-8-7	Two-sensor Operation	99
3-8-8	Initializing Settings	100
3-8-9	Monitor Focus Function	102
3-8-10	Differentiation Function.....	104
3-8-11	Display Reverse Function.....	104
3-8-12	ECO Display Function	104
3-8-13	Limiting the Number of Display Digits.....	105
3-8-14	Setting for Non-measurement.....	105
3-8-15	Zero Reset Memory Function	105
3-8-16	Gain Switch.....	105
3-8-17	Key Lock Function	106

3-1 ZX-L Series

The ZX Series are the first of the Smart Sensors from OMRON. In the ZX Series, ZX-L Laser Sensors include displacement (Reflective) and length-measuring (through-beam) sensors. The lineup is as follows:

Model	Sensing method	Function	Sensing center distance or sensing width
ZX-LDA11	-	Amplifier Unit: NPN output	-
ZX-LDA41	-	Amplifier Unit: PNP output	-
ZX-LD40	Diffuse reflective sensor	Sensor Head: Spot type	40 mm
ZX-LD100	Diffuse reflective sensor	Sensor Head: Spot type	100 mm
ZX-LD300	Diffuse reflective sensor	Sensor Head: Spot type	300 mm
ZX-LD40L	Diffuse reflective sensor	Sensor Head: Line type	40 mm
ZX-LD100L	Diffuse reflective sensor	Sensor Head: Line type	100 mm
ZX-LD300L	Diffuse reflective sensor	Sensor Head: Line type	300 mm
ZX-LD30V	Regular reflective sensor	Sensor Head: Spot type	30 mm
ZX-LD30VL	Regular reflective sensor	Sensor Head: Line type	30 mm
ZX-LT001	Through-beam sensor	Sensor Head	Sensing width: 1-mm dia.
ZX-LT005	Through-beam sensor	Sensor Head	Sensing width: 5 mm
ZX-LT010	Through-beam sensor	Sensor Head	Sensing width: 10 mm
ZX-CAL	-	Calculating Unit	-
ZX-XC1A	-	Extension Cable: 1 m	-
ZX-XC4A	-	Extension Cable: 4 m	-
ZX-XC8A	-	Extension cable: 8 m	-
ZX-XC9A	-	Extension cable: 9 m	-

3-1-1 ZX-L Series Outline

The ZX-L Series consists of high-accuracy, advanced sensors designed to use a laser light emitted onto the sensing object to measure the distance between the sensing object and the Sensor Head, judge the sensing object surface status, position, and obtain width measurements. A Sensor Head and Amplifier Unit are used in combination.

3-1-2 Sensor Heads

A Reflective Sensor Head measures the distance between the Sensor Head and the sensing object using emitter and receiver elements. The value is converted to an electric signal and sent to the Amplifier Unit.

With a Through-beam Sensor Head, the emitter radiates the laser beam as a collimated light beam, and the receiver senses the variation in incident level caused by the sensing object. The value is converted to an electric signal and sent to the Amplifier Unit.



Various settings of Amplifier Unit reset to the default status when the Sensor Head is replaced with one with a different sensing distance.

3-1-3 Amplifier Units

The signal from the Sensor Head is received and the value is displayed and output externally. Holding and timing controls are performed. In addition, two Amplifier Units can be connected to each other to perform calculations.

3-1-4 Calculating Unit

A Calculating Unit is required to connect two Amplifier Units.

Calculations of $A-B$ and $A+B$ can be performed when two Units are connected.

3-1-5 Channel Numbers of Amplifier Units

When two Amplifier Units are connected and set in the normal display direction, 1CH (channel 1) is used by the Unit on the top and 2CH (channel 2) is used by the Unit on the bottom.

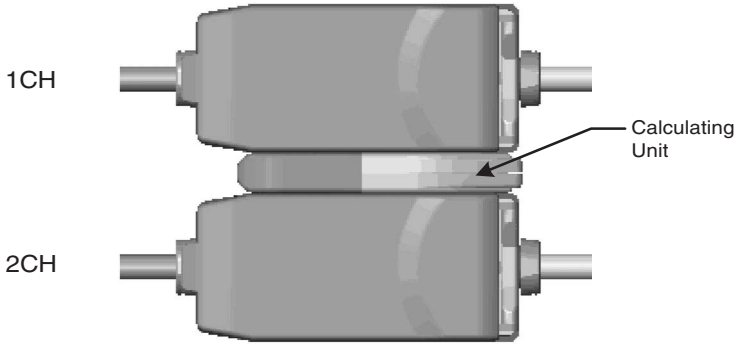

3-2 Hardware Functions

3-2-1 Inputs

Power Supply (12 to 24 VDC)

A 12 to 24-VDC power supply is connected to the power supply terminal. When using an Amplifier Unit with a PNP output, the power supply terminal is also the common I/O terminal for all I/O except for the linear output.

GND (0 V)

The GND terminal is the 0-V power supply terminal. When using an Amplifier Unit with an NPN output, the GND terminal is also the common I/O terminal for all I/O except for the linear output.

Laser OFF Input

When the Laser OFF input is turned ON, the laser emission will turn OFF, **L d o F F** will be displayed on the sub-display, and an optical level error will occur. The linear output, main display, judgement outputs, and judgement output indicators will be output according to the setting for non-measurement.

Zero Reset Input

The zero reset input is used to reset zero or to release the zero reset. The settings are as follows, according to the length of time the input is ON:

Input pulse ON time	Operation
0.2 to 0.8 s	Zero reset
Over 1 s	Zero reset release

The above operations are performed when the input is turned OFF.

Timing Input

The timing input is used to control the timing of the hold functions. Sampling is performed while this input is ON. It is used, for example, to hold a specified measured value from during the time that the timing input is ON.

Reset Input

The reset input is used to reset the outputs. When the reset input is turned ON, internal operation is interrupted and the specified values are output from the judgement and linear outputs.

The following values are output according to the setting for non-measurement.

Output	Setting for non-measurement	
	CLAMP	KEEP
Judgement outputs	All OFF	The values immediately before the non-measurement status are kept.
Linear output	Maximum output value is held.	
Main display	“- - - -”	
Sub-display	RESET	RESET

Maximum output voltage: Approximately 5.5 V

Maximum output current: Approximately 23 mA



The averaging operation is cleared for the reset input. The judgement output response thus may be slower than normal immediately after releasing the reset input.

3-2-2 Outputs

Judgement Outputs

There are three judgement outputs: HIGH, PASS, and LOW.

The following table and illustration show the timing of each output.

- **Threshold Values**

The threshold values form the boundaries between the HIGH, PASS, and LOW outputs for the measured value.

There are two threshold values: The HIGH threshold and the LOW threshold. The threshold values contain hysteresis.

- **Hysteresis**

The hysteresis (hysteresis width) is the difference between the operating and releasing values. If the hysteresis is too small, chattering may occur. If it is too large, releasing may be difficult.

Measured value	Judgement outputs
Larger than or equal to HIGH threshold	PASS → HIGH
Smaller than or equal to HIGH threshold – Hysteresis	HIGH → PASS
Smaller than or equal to LOW threshold	PASS → LOW
Larger than or equal to LOW threshold – Hysteresis	LOW → PASS

Timing of Changes in Judgement Outputs

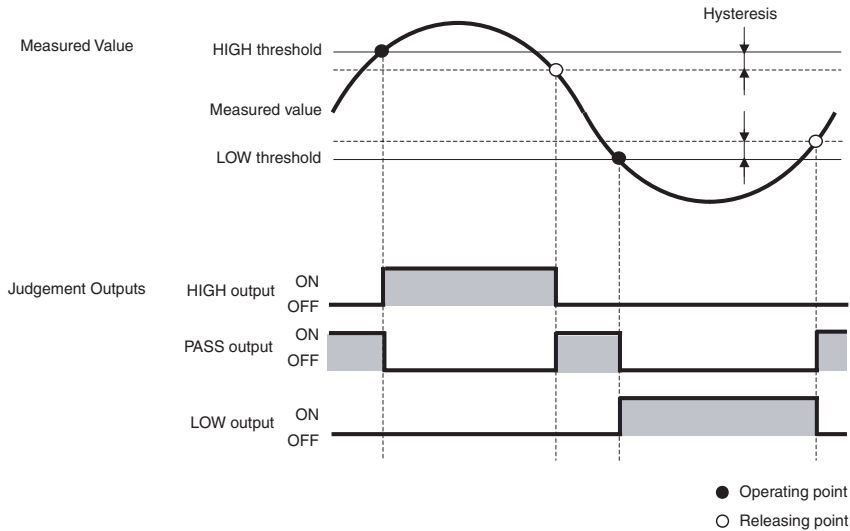

Relationship between Measured Value and Judgement Outputs

Linear Output

The linear output can be switched between current output and voltage output.

Output current range: 4 to 20 mA (default value: 4 to 20 mA)

Output voltage range: -5 to 5 V (default value: -4 to + 4 V)

The output scale can be changed using the monitor focus function. The maximum value of the current output is 23 mA and the maximum value of the voltage output is 5.5 V.

Linear Output GND

The linear output GND is the ground for the linear output. Connect it separately from the normal GND (0 V).

Always connect the linear output GND to ensure linearity and resolution for the linear output.

3-2-3 Performance

Linearity

The linearity indicates how much linearity is maintained by the linear output against the displacement amount (incident level). The linearity is evaluated as the percentage of full scale (FS) represented by the deviation from an ideal straight line.

For example, the 80 \pm 40-mm measurement range of the ZX-LD100 has a 160- μ m error, or a linearity of 0.2% FS.

Resolution

The resolution is the width of the deviations in the linear output. Width of deviation for the linear output is evaluated at $\pm 3\sigma$.

Temperature Characteristic

The temperature characteristic is measured as the deviation in the linear output against ambient temperature changes.

The temperature characteristic is evaluated as the percentage of change against FS for a 1°C temperature change (unit: %FS/°C).

Current Consumption

The current consumption is the maximum current consumed by the product. Use it as a guideline to supply electric current and power.

In addition, if the product's current consumption is greater than or equal to the specified current consumption, an error may have occurred in the product. Immediately replace or repair it.

Ambient Operating Temperature

The ambient operating temperature is the temperature range for which specifications are given.

Ambient Operating Humidity

The ambient operating humidity is the humidity range for which specifications are given.

Dielectric Strength

The dielectric strength is the voltage the product can endure when voltage is applied between the product case and the charged parts.

Vibration Resistance

The vibration resistance is the vibration level that can be applied to the product without affecting continued normal product operation.

Degree of Protection

The degree of protection indicates the tolerance of the product against dust and water. An "IP50" degree of protection indicates the following:

- The amount of dust that may enter the product will not interfere with normal equipment operation and will not adversely affect safety.
- No special water protection is provided.

3-3 Reflective Sensor Heads: RUN Mode Functions

3-3-1 Sub-display Changes

Items shown on the sub-display can be selected.

When Intensity Mode is OFF, the threshold values (HIGH/LOW), voltage value, current value, incident level, or resolution can be selected.

When Intensity Mode is ON, the threshold values (HIGH/LOW), voltage value, current value, or resolution can be selected.

- Voltage display … The voltage level of the linear output is displayed.
- Current display … The current level of the linear output is displayed.
- Incident level display … The incident level is displayed (0 to 9999)
- Resolution display … The resolution of linear output is displayed.



Display values are provided as reference values. There may be some discrepancies in actual outputs.

The incident level displayed here is different from the one displayed on the main display when Intensity Mode is ON.

3-3-2 Zero Reset/Release

The following are performed for the zero reset function:

- Setting the display value to 0.
- Setting the linear output to the center output value between two points set for the monitor focus when 0 is displayed (default current output: 12 mA, default voltage output: 0 V).

The zero reset can be also released.



The inclination of the linear output value against the actual distance does not change when the zero reset is executed.

An error will occur if the zero reset is performed outside the measurement range.

Reference ➤ Refer to 4-3-4 Zero Reset Function.

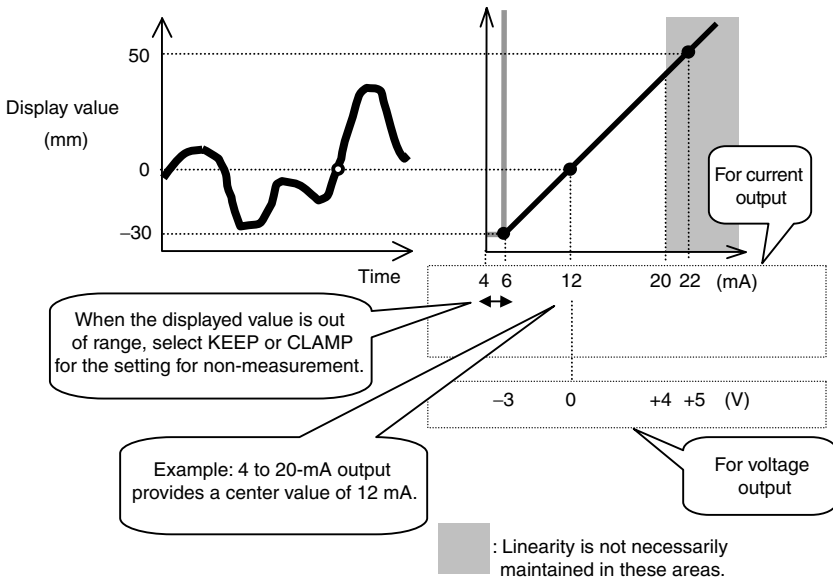
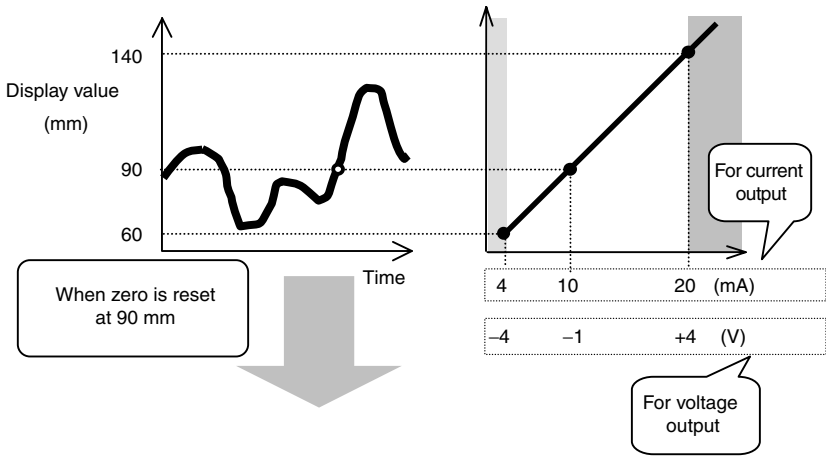

Changes in Display Value and Linear Output for Zero Reset

Example: Use Zero Reset to Evaluate the Height of a Step in the Sensing Object

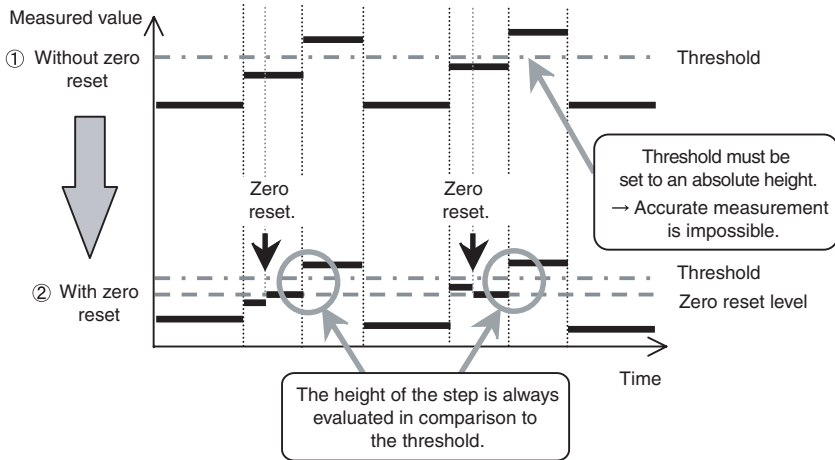
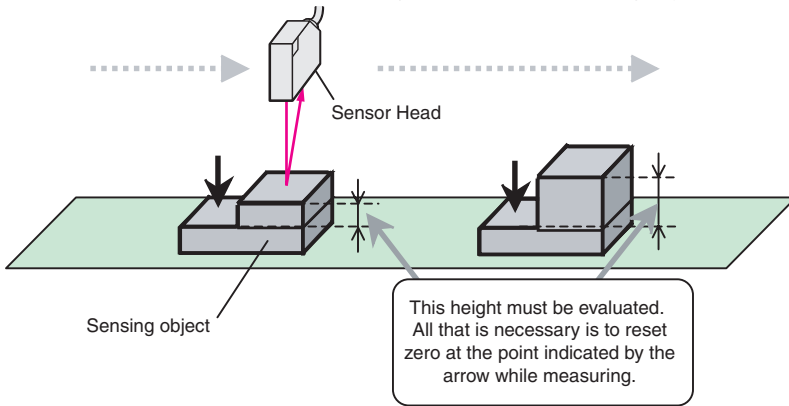

Example: Zero Reset During Measurement



In this case, disabling the zero reset memory is recommended.

Reference » Refer to 3-5-15 Zero Reset Memory Function.

3-4 Reflective Sensor Heads: T Mode Functions

3-4-1 Teaching

“Teaching” is used to perform calculations in the Sensor to automatically determine the threshold values by creating an actual operating environment and detecting objects. After teaching, the threshold values can be precisely adjusted or teaching can be performed as many times as required.

There are three kinds of teaching: Position teaching, two-point teaching, and automatic teaching.

Reference » Refer to 4-4-1 Teaching Procedures.

■ Position Teaching

When teaching is executed, the measured value is set as a threshold.

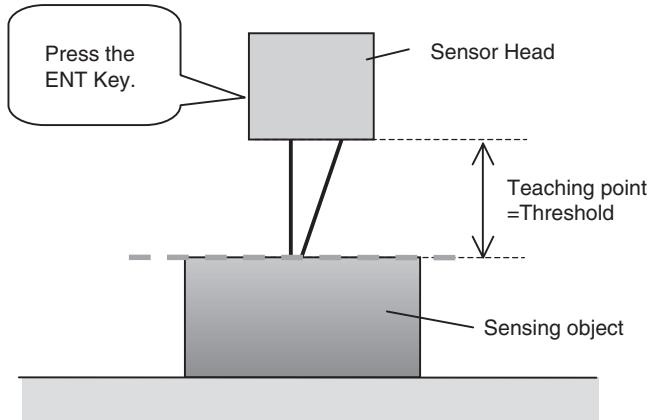

Example: Position Teaching

■ Two-point Teaching

The middle point between the first teaching point and the second point is set as a threshold. With two-point teaching, small steps, such as a sheet of paper, can be measured.

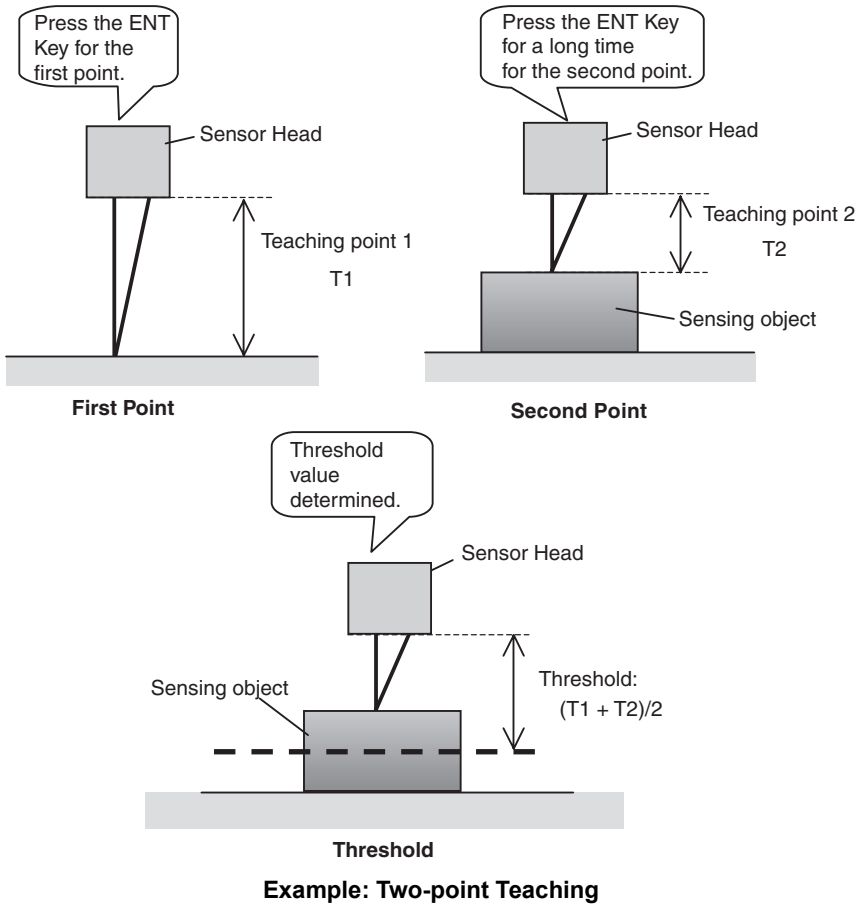

■ **Automatic Teaching**

For automatic teaching, measurements are performed while the RIGHT Key and the ENT Key are pressed at the same time. The center value between maximum and minimum values is set as a threshold.

The threshold value is set when the keys are released.

The threshold can be set according to the sensing object.

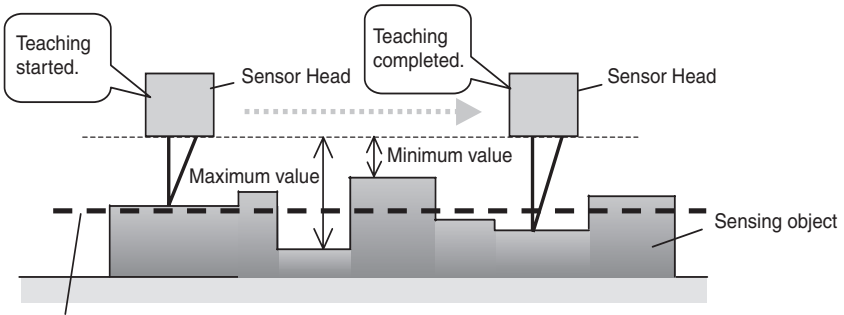

Threshold:
 $(\text{Maximum value} - \text{Minimum value})/2$

Example: Automatic Teaching

3-4-2 Inputting Threshold Values Directly

Threshold values can be directly input into the sub-display.

Note: Generally, any value can be input. The judgement outputs, however, will not operate for thresholds that are outside the measurement range. Also, the decimal point cannot be changed.

Reference » If an error occurs when inputting a threshold value, refer to 4-4-2 *Inputting Threshold Values Directly* and 5-2-3 *Unable to Set Threshold Values*.

3-5 Reflective Sensor Heads: FUN Mode Functions

3-5-1 Scaling

Scaling is used to arbitrarily change the display value for the actual distance. The display value for any distance can be input or changed.

When scaling one point, the display value offset is changed; the display value range is not changed. When scaling two points, both the range and offset of display values are changed.

One-point Scaling

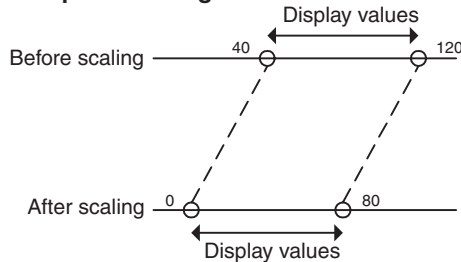

Although the range cannot be changed, the offset can be changed.

Two-point Scaling

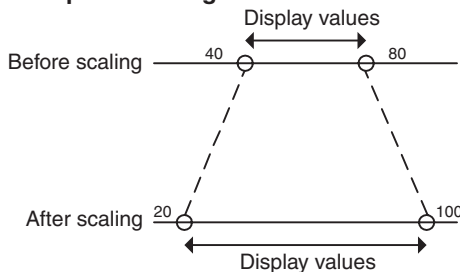

The range and offset can be changed.

Reference » **Refer to 4-5-7 Setting Scaling.**

Note: The display values for actual distances change when scaling is set, but the linear output values will remain unchanged.

The relation between actual distances and linear output values is set with the monitor focus function. To alter the output values, set the monitor focus after setting scaling.

Reference » **Refer to 3-5-8 Monitor Focus Function.**

● Inverting Display Values

When inverting the display values is set, the display values will be in an inverse relationship to the reference values.

Normally, the more the distance between Sensor and sensing object increases, the larger the display value becomes. However, if the display values are inverted, the more the distance increases, the smaller the display value will become.

Inverting display values is not possible when two-point scaling is used.



When any of the following changes is performed, the scaling function is automatically cleared and must be performed again.

- Turning ON or OFF Intensity Mode.
- Enabling or disabling two-sensor operation A + B.
- Enabling or disabling two-sensor operation A – B.

Reference »» When scaling cannot be set correctly, refer to 5-2-1 *Unable to Set Scaling.*

■ **Offsetting Display Values: One-point Scaling A**

Use one-point scaling to offset the display values. Input the distance to be displayed for the current measurement point. When you input only one point for scaling, only the offset is changed without changing the range of display values. In this example, the display values are not inverted.

Example:

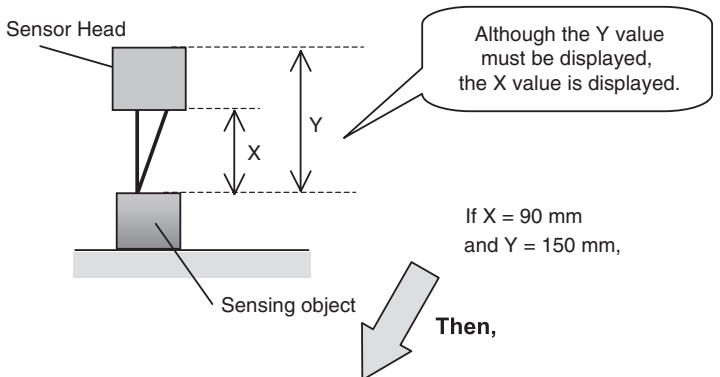

Before scaling	
Measured value = Display value	
80.0	
90.0	
100.0	
110.0	

After scaling	
Display value	Measured value
140.0	80.0
150.0	90.0
160.0	100.0
170.0	110.0

█ : Scaling value input

90 mm is displayed as 150 mm.

All values are shifted.

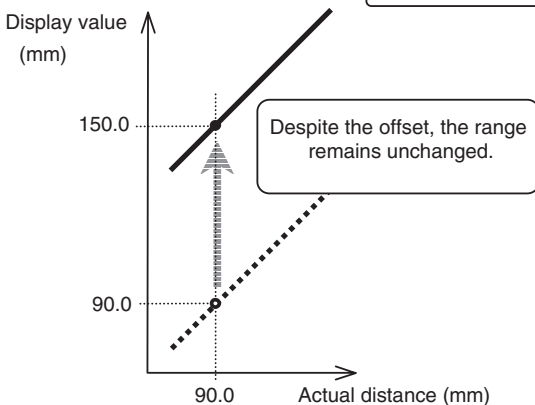

Example: One-point Scaling A

■ **Displaying the Height of the Sensing Object: One-point Scaling B**

The height of the sensing object can be displayed by using one-point scaling and inverting the display values.

When the display values are inverted, the larger the displacement, the smaller the display value. Therefore, the height of the sensing object can be displayed after inputting the height of a known sensing object.

Because one-point scaling is used, the range of display values is not changed. The linear output also remains unchanged.

Example:

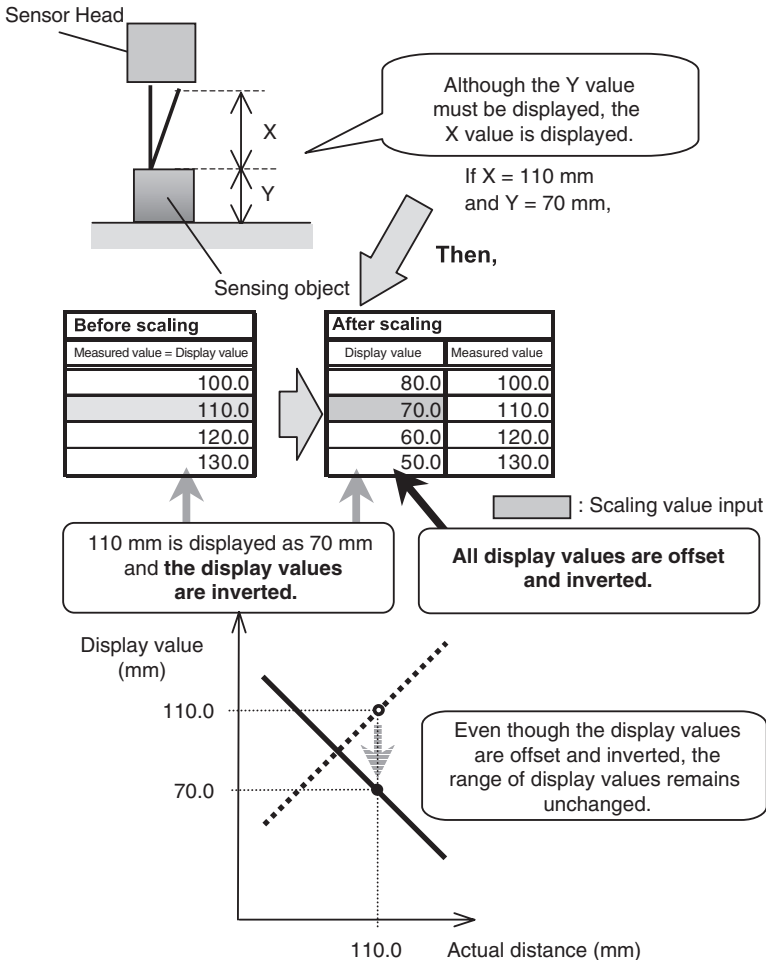

Example: One-point Scaling B

- Correcting Display Values to Match Actual Distances: Two-point Scaling A**
 Display values can be corrected if there is a discrepancy between the actual distance from the Sensor Head to the sensing object and the value displayed on the Amplifier Unit. When actual distances are known, they are input at two points to correct the range and offset of display values (see following figure).

Reference ➤ To change only the offset without changing the range of display values, refer to **Offsetting Display Values: One-point Scaling A**.

Example:

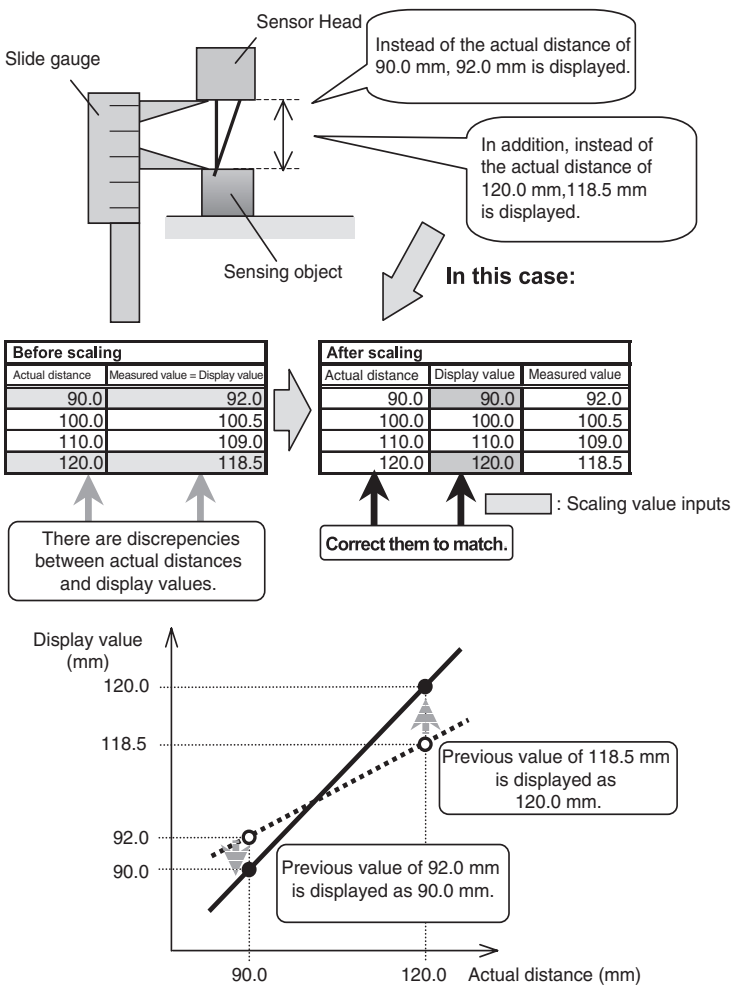

Example: Two-point Scaling A

■ **Displaying Arbitrary Values: Two-point Scaling B**

Any display value can be achieved using the same method as for the two-point scaling A. Any value can be input for two points to change the range and offset of display values (see following figure).

Example:

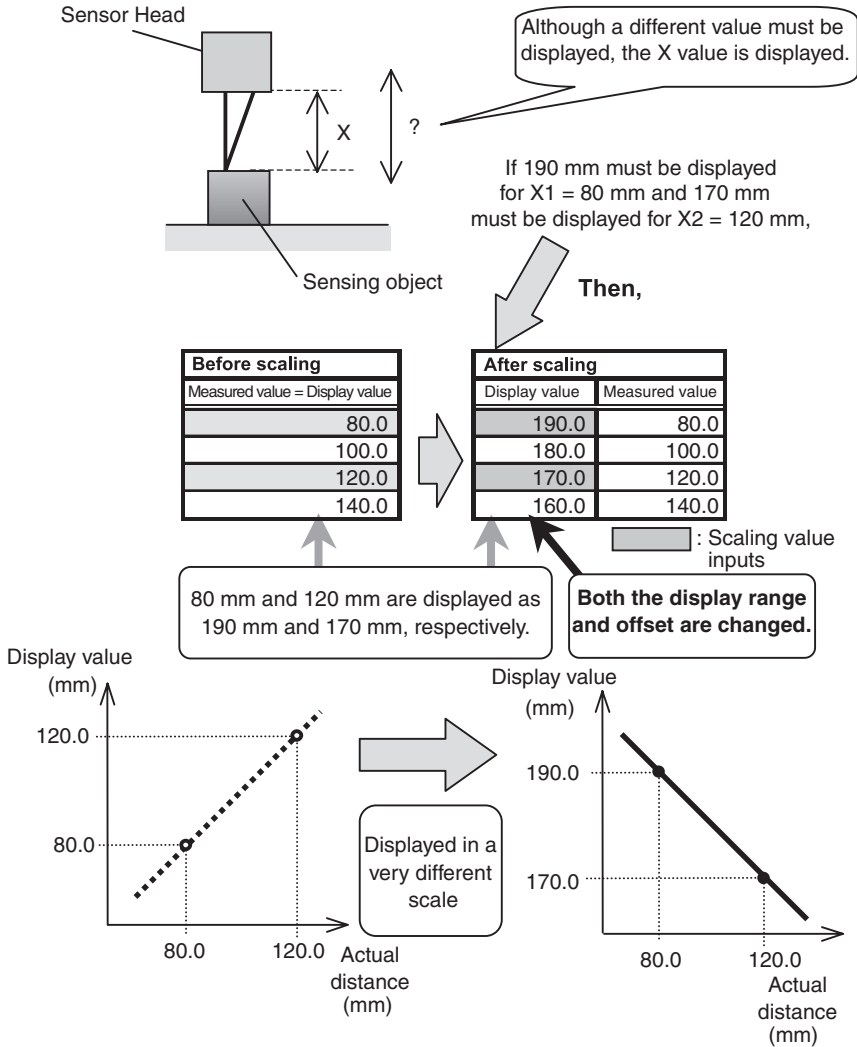

Example: Two-point Scaling B

■ **Measuring Thicknesses of Sensing Objects: One-point Scaling C**

The thickness of a sensing object can be measured by using two-sensor operation and one-point scaling (and inverting display values). Perform the two-sensor operation A+B to display the sum of the measured values for two Sensor Heads. Settings are made on the 2CH Amplifier Unit.

Reference » Refer to 3-5-6 Two-sensor Operation.

Next, set the actual sensing object and set the value to be displayed in the scaling mode. Then, set to enable inverting the display values so that smaller values are displayed when larger values are measured (i.e., when thinner sensing objects are measured). Two-point scaling can be also used if both sensing object thicknesses are known.

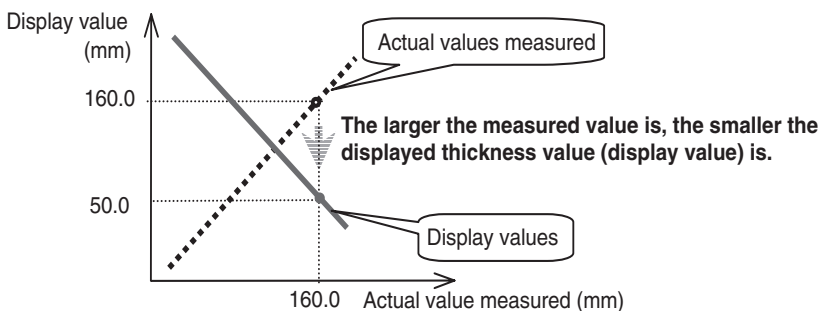
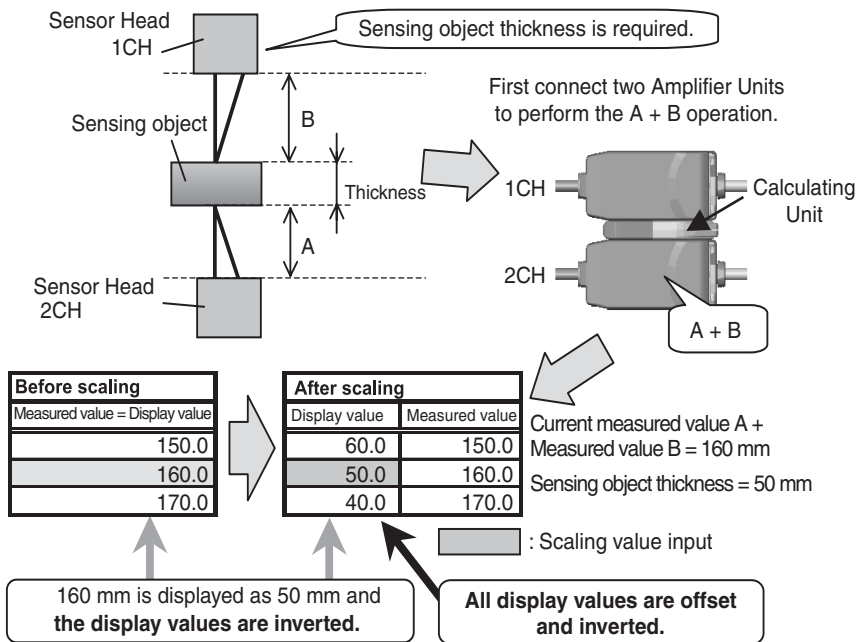

Example: One-point Scaling C

3-5-2 Number of Samples to Average

The number of samples to average is the number of data points used to average data measured by the Sensor.

Increase the number of samples to average to decrease variations in order to achieve fine positioning and judgement. If the number of samples is increased, however, the response time of the judgement outputs and linear output will be increased.

The following table shows the relationship between the number of samples to average and the response time.

Number of samples to average	Response time (ms)
1	0.3
2	0.5
4	0.8
8	1.5
16	2.5
32	5
64	10
128	20
256	40
512	75
1,024	150
2,048	300
4,096	600

Number of Samples to Average and Response Time

- Note**
1. If the number of samples to average is increased n times, the resolution is generally improved \sqrt{n} times.
 2. When the reception sensitivity (corresponds to the internal gain) is changed, the response time may be slower than that listed in the table. If the response delay is unacceptable, correct the gain using the gain switch function.

Reference » Refer to 4-5-12 Other Special FUN Mode Settings.

3-5-3 Hysteresis Setting

The hysteresis of the threshold values (hysteresis width) can be set. Any value can be input directly or the hysteresis can be set automatically.

Reference » Refer to *4-5-6 FUN Mode Status Transitions*.

Reference » If the hysteresis cannot be set, refer to *5-2-4 Unable to Set Hysteresis*.

When the hysteresis is set automatically, the hysteresis width is almost equal to the resolution.

3-5-4 Hold Functions

The hold functions extract, output, and display data for specific points, such as the maximum value, the minimum value, etc.

There are six hold functions: Peak hold, bottom hold, sample hold, peak-to-peak hold, self-peak hold, and self-bottom hold.

Reference » Refer to *4-5-6 FUN Mode Status Transitions*.

Reference » Refer to ■ **Judgement Outputs in Hold Mode for information on the judgement outputs when using a Hold Mode.**

Note: The following notes apply to Hold Mode.

- (1) The zero reset input is disabled while sampling (i.e., while the timing input is ON) in Hold Mode or while _____ is displayed on the main display.
- (2) When non-measurement status occurs (i.e., the reset input turns ON or a reception error occurs) during sampling (i.e., while the timing input is ON) in Hold Mode, the extracted data will be discarded. Sampling continues until the timing input is turned OFF. When an incident level error occurs continuously during the sampling, "Error" is displayed when holding.
- (3) The timing input does not affect sampling during the self-peak hold or the self-bottom hold.
- (4) Do not enable the timer in Hold Mode.

■ Normal Mode (Hold Not Enabled)

In Normal Mode, the measured value is always displayed and output. The timing input is disabled and no hold function will operate.

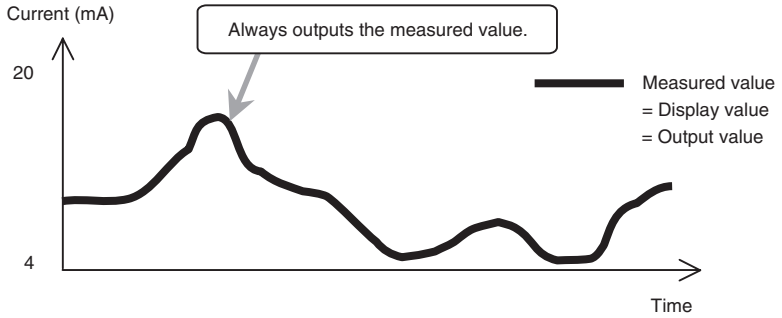

■ Peak Hold

In Peak Hold Mode, measurements are performed while the timing input is ON, and the maximum value during the sampling period will be the output value.

Hold Mode starts when the power is turned ON, immediately after changing to RUN or T Mode, or immediately after the reset input is turned OFF.

The output is held at the maximum output (current: approximately 23 mA, voltage: approximately 5.5 V) until the first sampling period is finished. The first measured result (A in the figure below) is output from the end of the first sampling period to the end of the second sampling period. After the second sampling period, the second measured result (B in the figure below) is output and the sequence is repeated.

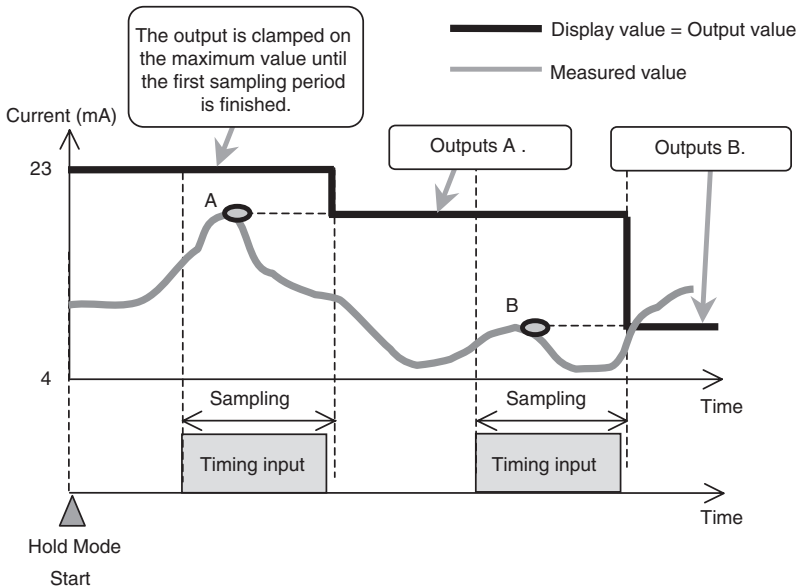

Example: Peak Hold

■ **Bottom Hold**

In Bottom Hold Mode, measurements are performed while the timing input is ON, and the minimum value during the sampling period will be the output value.

Hold Mode starts when the power is turned ON, immediately after changing to RUN or T Mode, or immediately after the reset input is turned OFF.

The output is held at the maximum output (current: approximately 23 mA, voltage: approximately 5.5 V) until the first sampling period is finished. The first measured result (A in the figure below) is output from the end of the first sampling period to the end of the second sampling period. After the second sampling period, the second measured result (B in the figure below) is output and the sequence is repeated.

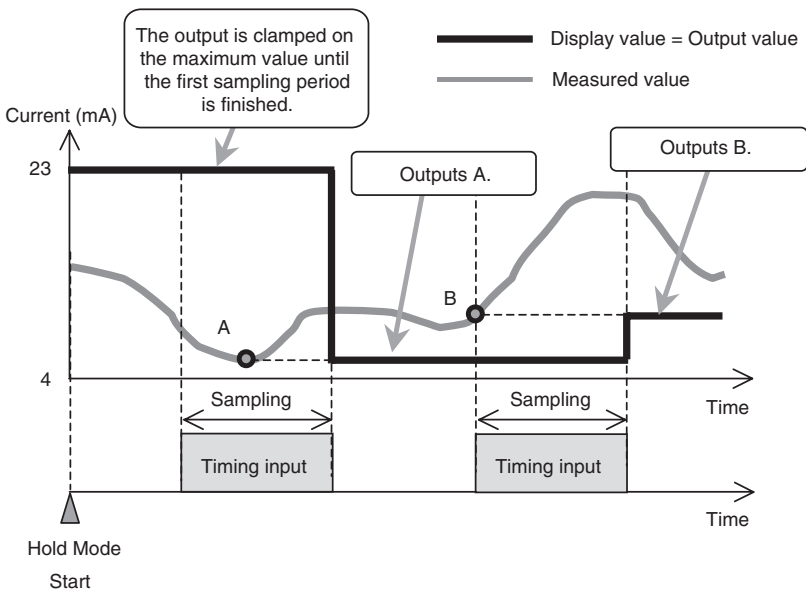

Example: Bottom Hold

■ **Sample Hold**

In Sample Hold Mode, the measured result when the timing input is turned ON will be the output value.

Hold Mode starts when the power is turned ON, immediately after changing to RUN or T Mode, or immediately after the reset input is turned OFF.

The output is held at the maximum output (current: approximately 23 mA, voltage: approximately 5.5 V) until the first time the timing input turns ON. The first measured result (A in the figure below) is output from the beginning of the first sampling period to the second sampling period. After the beginning of the second sampling period, the second measured result (B in the figure below) is output and the sequence is repeated.

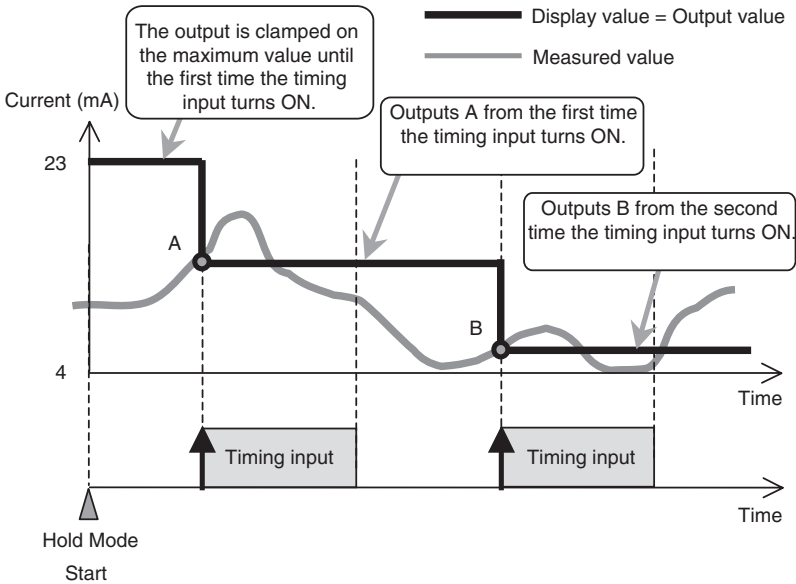

Example: Sample Hold

■ **Peak-to-peak Hold**

In Peak-to-peak Hold Mode, measurements are performed while the timing input is ON, and the difference between the maximum value and the minimum value in the sampling period will be the output value.

Hold Mode starts when the power is turned ON, immediately after changing to RUN or T Mode, or immediately after the reset input is turned OFF.

The output is held at the maximum output (current: approximately 23 mA, voltage: approximately 5.5 V) until the first sampling period is finished. The first measured result ($P_1 - B_1$ in the figure below) is output from the end of the first sampling period to the end of the second sampling period. After the second sampling period, the second measured result ($P_2 - B_2$ in the figure below) is output and the sequence is repeated.

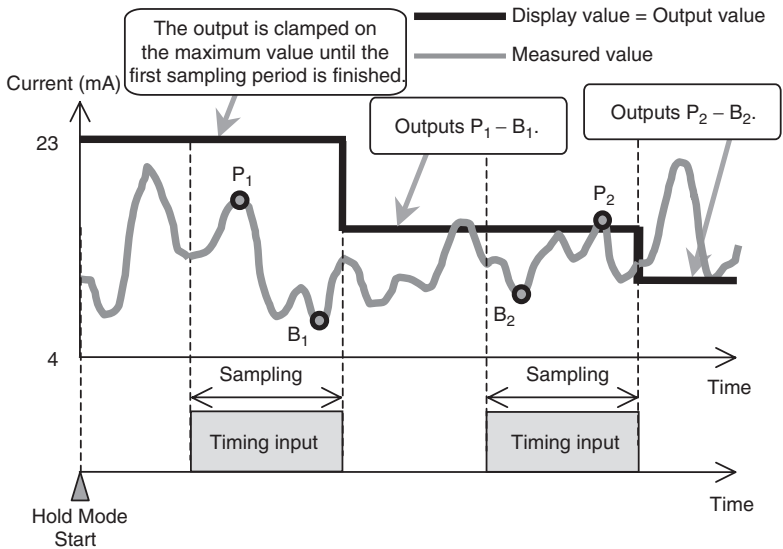

Example: Peak-to-peak Hold

■ **Self-peak Hold**

In Self-peak Hold Mode, measurements are performed while the measured value is larger than or equal to the self-trigger level, and the maximum value in the period will be the output value.

Hold Mode starts when the power is turned ON, immediately after changing to RUN or T Mode, or immediately after the reset input is turned OFF.

The output is held at the maximum output (current: approximately 23 mA, voltage: approximately 5.5 V) until the first sampling period is finished. The first measured result (A in the figure below) is output from the end of the first sampling period to the end of the second sampling period. After the second sampling period, the second measured result (B in the figure below) is output and the sequence is repeated.

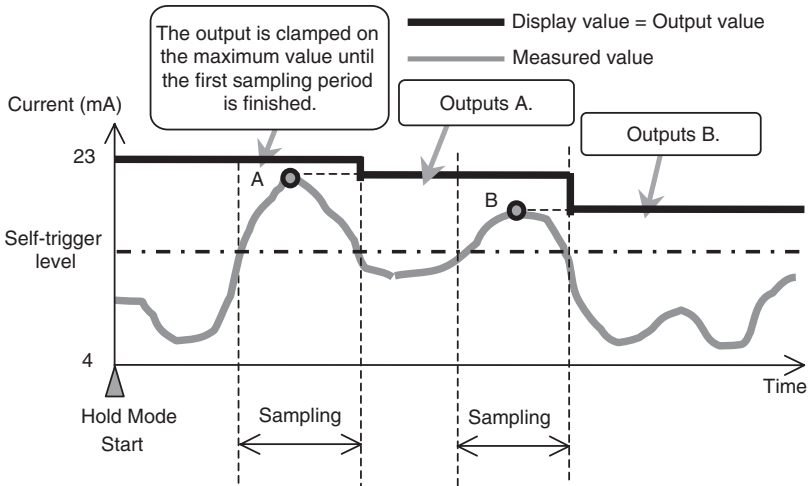

Example: Self-peak Hold

■ **Self-trigger Level**

The self-trigger level is the threshold value for which measured value sampling is performed. In Self-peak Hold Mode, sampling starts when the measured value becomes larger than or equal to this value and sampling ends when the measured value becomes smaller than or equal to this value. The maximum value during this period is the hold value.

In Self-bottom Hold Mode, sampling starts when the measured value becomes smaller than or equal to this value and sampling ends when the measured value becomes larger than or equal to this value. The minimum value during this period is the hold value.

Note: Hysteresis (hysteresis width) is applied to the self-trigger level. The hysteresis is generated when sampling ends ($\pm 3\%$ FS).

■ Self-bottom Hold

In Self-bottom Hold Mode, measurements are performed while the measured value is smaller than or equal to the self-trigger level, and the minimum value in the period will be the output value.

Hold Mode starts when the power is turned ON, immediately after changing to RUN or T Mode, or immediately after the reset input is turned OFF.

The output is held at the maximum output (current: approximately 23 mA, voltage: approximately 5.5 V) until the first sampling period is finished. The first measured result (A in the figure below) is output from the end of the first sampling period to the end of the second sampling period. After the second sampling period, the second measured result (B in the figure below) is output and the sequence is repeated.



Sampling is not affected by the timing input in Self-bottom Hold Mode.

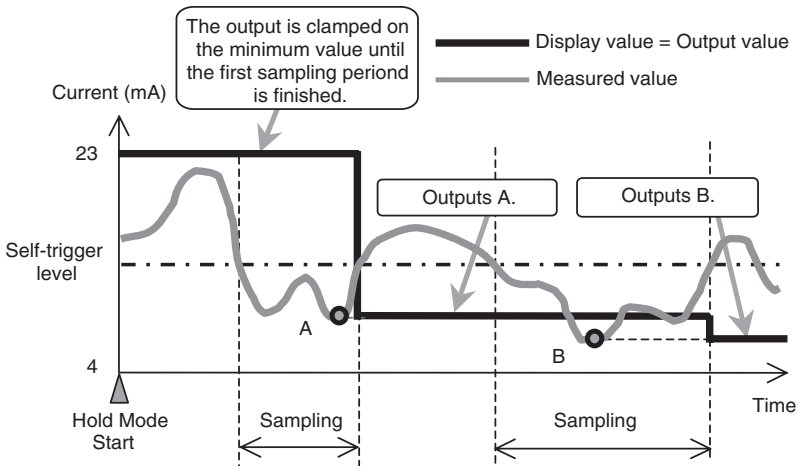

Example: Self-bottom Hold

■ Judgement Outputs in Hold Mode

The judgement outputs during Hold Mode are based on the value that is held (= the display value). Therefore, when using Hold Mode, the linear output, judgement outputs, and display value remain unchanged before the end of the next sampling period. Other status is as follows from when Hold Mode is started until the first hold value is determined:

- Linear output: Clamped on the maximum output.
- Judgement outputs: All OFF
- Main display: -----



Sampling is not affected by the timing input in Self-peak Hold Mode.

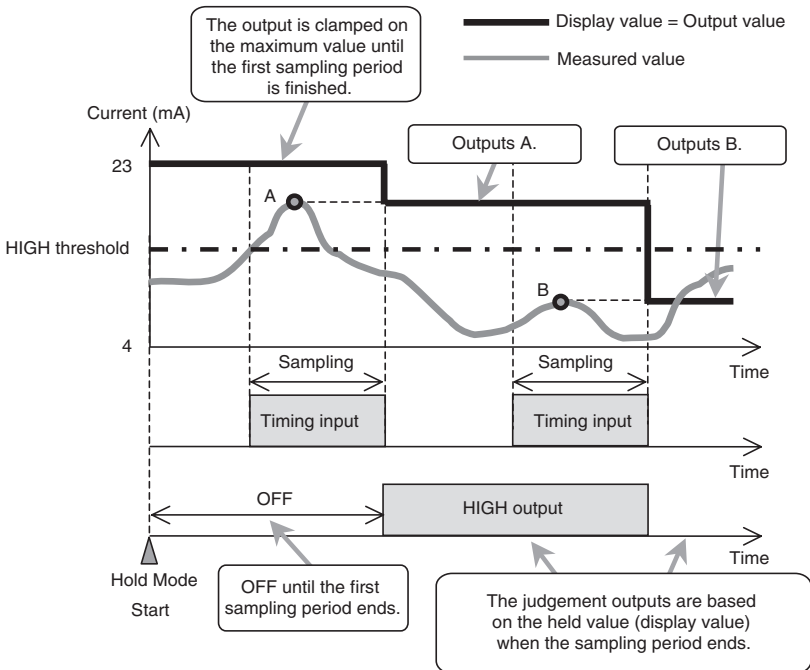

Example: Judgement Outputs during Peak Hold

3-5-5 Timer

■ Timer Time

The time set for the timer is the delay time for the ON-delay timer, the delay time for the OFF-delay timer, or the pulse width for the one-shot timer. Set the time according to the requirements of the control system (e.g., PLC). The timer time can be set to between 0 and 5,999 ms.

■ Timer Disable

If the timer is disabled, judgement outputs will be made immediately and the output response time will be determined by the number of samples to average.

■ OFF-delay Timer

When the measured value changes from HIGH to PASS or from LOW to PASS, turning OFF the PASS output is delayed for the timer time.

■ ON-delay Timer

When the measured value changes from HIGH to PASS or from LOW to PASS, turning ON the PASS output is delayed for the timer time.

■ One-shot Timer

When the measured value changes from HIGH to PASS or from LOW to PASS, the PASS output is turn ON with a pulse width equivalent to the timer time.

When PASS output pulses overlap, the latter pulse has priority. Therefore, overlapping pulses might sometimes become a single pulse rather than separate pulses.

Note: Neither the HIGH nor the LOW output are output when the one-shot timer is selected.

Reference ►► Refer to *4-5-6 FUN Mode Status Transitions*.

The timing chart is shown below.

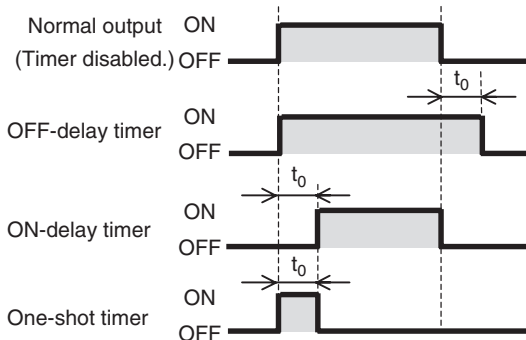

Changes for Different Types of Timer and PASS Output (Timer Time: t_0)

The timer process is applied to the PASS output. This means that an ON-delay timer of t_0 is applied to the HIGH output when the OFF-delay timer of t_0 is applied to the PASS output when the measured value changes from PASS to HIGH as shown in the following figure.

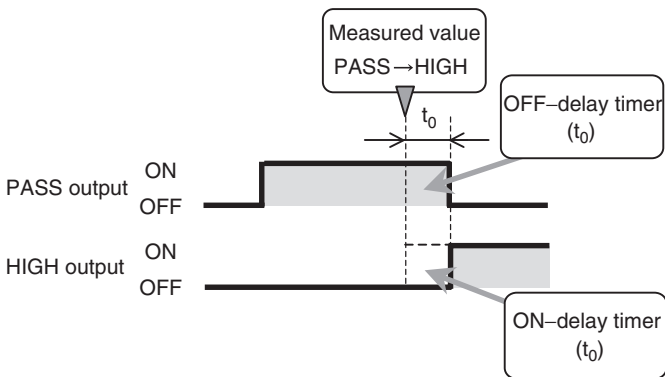

Delay Timer Applied to PASS Output

Example: OFF-delay Timer (t_0) Going from PASS to HIGH

3-5-6 Two-sensor Operation

Two-sensor operation enables mutual operation using the measured values from the two Sensor Heads to generate final outputs. Two kinds of outputs, A-B or A+B, can then be selected.



When two-sensor operation is selected, any scaling that is set for each Sensor Head will be reset to the defaults. When scaling is required during two-sensor operation, perform scaling after enabling two-sensor operation.



When setting the Amplifier Units, set the 1CH Amplifier Unit to RUN, then perform the settings for the 2CH Amplifier Unit.

Note: The ranges of display values and linear output values are automatically doubled when two-sensor operation is used. An example application of Sensor Heads is given in the following table when the sensing distance is 100 ± 40 mm.

Linear output	4 to 20 mA
A - B	-80 to 80
A + B	120 to 280

Note: Correct distance operation cannot be performed if Sensor Heads with different sensing distances are used.

■ **A – B**

The difference between the measured values of the two Sensor Heads is the final output. The measured value of the 1CH Amplifier Unit is B and the measured value of the 2CH Amplifier Unit is A.

■ **A + B**

The sum of measured values of the two Sensor Heads is the final output. The measured value of the 1CH Amplifier Unit is B and the measured value of the 2CH Amplifier Unit is A.

■ **Operation Result Output**

The result of the operation is displayed on and output from the 2CH Amplifier Unit. The B measured value is displayed on and output from the 1CH Amplifier Unit.



When the sensing object thickness is measured, change the display value using the scaling function after selecting A + B operation.

Reference » Refer to 3-5-1 *Scaling*.

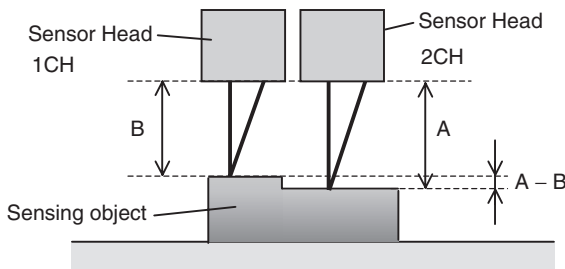

Example: A – B

3-5-7 Initializing Settings

All setting conditions can be initialized. Special settings, such as for the monitor focus function and the scaling function, are also initialized.

Note: Once initialized, the settings cannot be reset to the previous ones. Keep in mind that all settings must be made from the beginning if required settings are inadvertently initialized.

● **Default Settings**

The settings are initialized to the default setting made at the factory. The default settings are listed in the following table.

Mode	Function	Initial value
FUN	Scaling values	Maximum display value: Maximum sensing distance
		Minimum display value: Minimum sensing distance
	Number of samples to average	256 samples
	Hysteresis	1% of total sensing distance range
	Hold Mode	OFF (disabled)
	Timer	OFF (disabled)
	Two-sensor operation (when two Amplifier Units are connected)	OFF (disabled)
	Special selection	CLOSE
	Monitor focus function	4 V (20 mA): Maximum sensing distance
		-4 V (4 mA): Minimum sensing distance
	Intensity Mode	OFF (disabled)
	Differentiation function	OFF (disabled)
	Display reverse function	OFF (disabled)
	ECO display function	OFF (disabled)
	Limited number of display digits	All digits displayed
	Settings for non-measurement	KEEP
	Zero reset memory function	ON
	Gain switch	AUTO
T	HIGH threshold	Maximum sensing distance
	LOW threshold	Minimum sensing distance
RUN	Sub-display function	Threshold values
	Zero reset function	OFF (disabled)

Reference ➤ **Refer to 4-5-8 Initializing Settings.**

3-5-8 Monitor Focus Function

The linear output range and inclination for display values can be specified. These are set by defining two output values for specified display values.

Reference » Refer to 4-5-10 *Setting the Monitor Focus*.

Reference » When the monitor focus function cannot be set correctly, refer to 5-2-2 *Unable to Set Monitor Focus*.

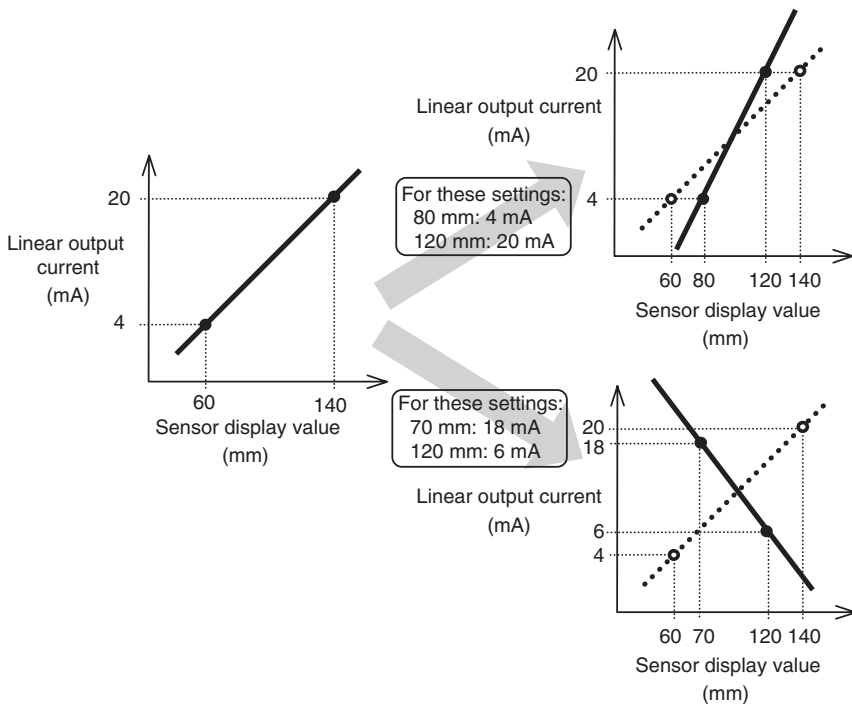

Examples: Monitor Focus 1

Note: The zero reset is automatically cleared when the monitor focus is set.

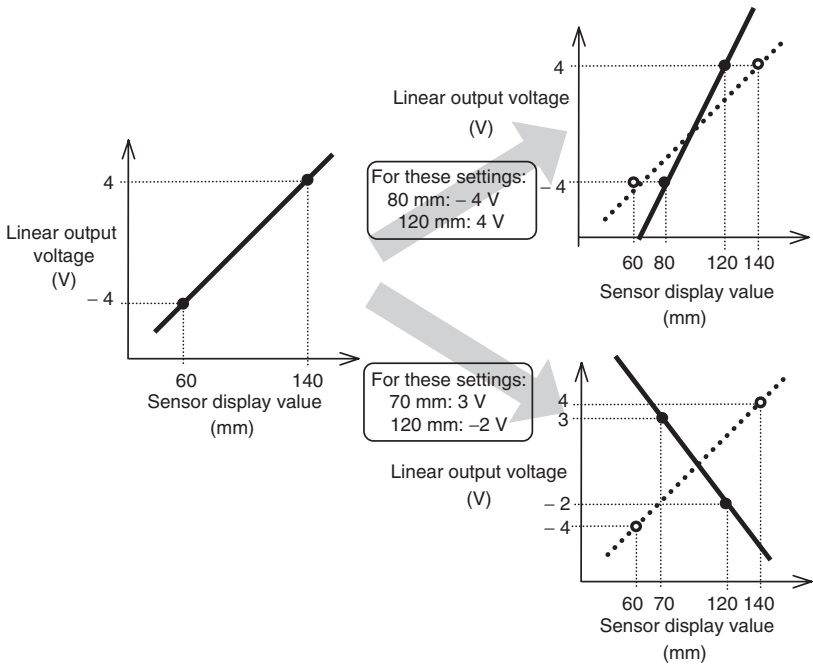

Examples: Monitor Focus 2

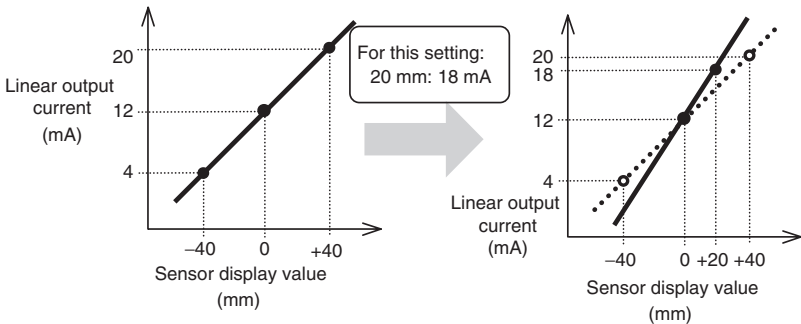

Examples: Monitor Focus 3, Enabling Differentiation

3-5-9 Intensity Mode

The Intensity Mode can be selected either when using distance values for display and output values or when using the received intensity (light level).

When the Intensity Mode is entered, the following are changed: Threshold values (HIGH and LOW), hysteresis (hysteresis width), self-trigger level, monitor focus function values, and the data for the received amount.

Note: Set the gain switch to **Auto** when using Intensity Mode.

3-5-10 Differentiation Function

The differentiation function is used to convert variations in measured values into output values. Use it for measurements that monitor changes in measured values, such as counting the number of sheets.

When the Differentiation Mode is enabled, the number of cycles (measurement periods) to be compared can be set. (1 cycle: 150 μ s)

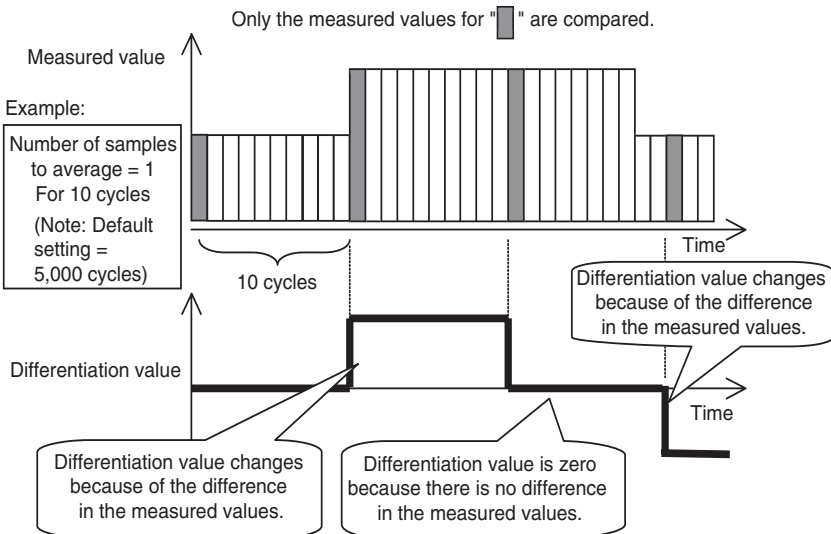

Example: Measured Values and Differentiation Values



The variation in the measured values indicates the difference between the previous and current measured values. This value will decrease when the number of samples to average is increased.

3-5-11 Display Reverse Function

The display direction of the digital displays can be selected. Select either forward or backward according to the mounting direction of the Amplifier Unit.

Reference » Refer to 4-5-11 *Special FUN Mode Settings Related to Displays.*

3-5-12 ECO Display Function

The ECO display function can be enabled or disabled. When the ECO display function is enabled, the digital display will not light.

3-5-13 Limiting the Number of Display Digits

The number of display digits of the main display and sub-display can be set. When the number of digits is reduced, the rightmost digit is disabled first. In addition, if 0 digits are specified, the entire digital display will be disabled. This applies, however, only in RUN Mode.

3-5-14 Setting for Non-measurement

The output method used during non-measurement can be set. This setting applies when a reset is input or a reception error occurs.

Outputs	Setting for non-measurement	
	CLAMP	KEEP
Judgement outputs	All OFF.	The status immediately before measurement stopped is held.
Linear output	Held at the maximum output value.	

Maximum output voltage: Approximately 5.5 V

Maximum output current: Approximately 23 mA

Reference » Refer to 4-5-12 *Other Special FUN Mode Settings.*

3-5-15 Zero Reset Memory Function

If required, the zero reset level can be stored when the power supply is turned OFF. Enable this function when the previous zero reset level must be restored when the power supply is turned ON again.

When this function is enabled, the zero reset level data will be written in nonvolatile memory (EEPROM). The EEPROM can be written a maximum of 100,000 times. Therefore, disable this function in order to preserve the memory when using the zero reset for every measurement.

Even when the zero reset memory function is disabled, the zero reset level will be rewritten to EEPROM at the following times.

- When the threshold values are set.
- When settings are performed in FUN Mode.

3-5-16 Gain Switch

The gain switch selects either fixed or automatically switching the reception sensitivity (corresponds to the internal gain). The gain switch should normally be set to automatic switching.

If automatic is selected, the response time may be delayed when the measured value and the resultant gain change.

The gain can be fixed to keep the response time constant.

Note: If an appropriate value is not set as the gain for the sensing object color, distance, etc., the output may soon saturate and reach non-measurement status.

3-5-17 Key Lock Function

The keys can be disabled on the Amplifier Unit. Once the keys have been disabled, no key input will be accepted until the lock is released.

Use this function to prevent inadvertent changes to settings.

Reference » **Refer to 4-5-5 Key Lock.**

3-6 Through-beam Sensor Heads: RUN Mode Functions

3-6-1 Sub-display Changes

Items shown on the sub-display can be selected.

The threshold values (HIGH/LOW), voltage value, current value, incident level, and resolution can be selected.

- Voltage display ... The voltage level of the linear output is displayed.
- Current display ... The current level of the linear output is displayed.
- Incident level display ... The incident level is displayed (0 to 100)
- Resolution display ... The resolution of linear output is displayed.



Display values are provided as reference values. There may be some discrepancies in actual outputs.

The incident level displayed here is different from the one displayed on the main display.

3-6-2 Reference Incident Level Setting Function

This function registers and stores the current incident level as the reference incident level. This function is set under the condition that none of the beam is intercepted. The incident level obtained with none of the beam intercepted will be the full scale (FS) value, i.e. the incident beam when 100% of the beam is received.

When this function is used, the display and linear output are automatically set to the full scale (FS) value. This function can also be used to correct the incident level when it changes due to contamination on the front-surface glass.

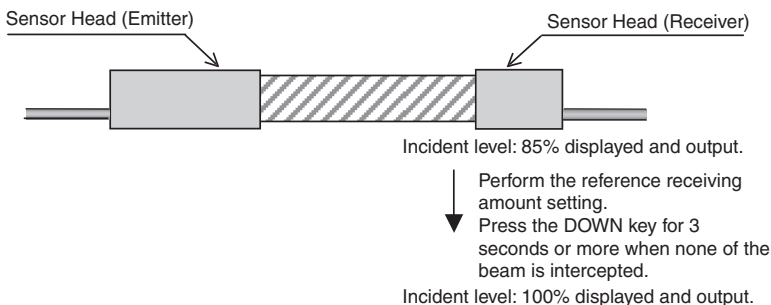

Reference »» For the setting procedure, refer to 4-3-3 Setting the Reference Incident Level.

3-6-3 Zero Reset/Release

The following are performed for the zero reset function:

- Setting the display value to 0.
- Setting the linear output to the center output value between two points set for the monitor focus when 0 is displayed (default current output: 12 mA, default voltage output: 0 V).

The zero reset can be also released.



The inclination of the linear output value against the actual distance does not change when the zero reset is executed.

An error will occur if the zero reset is performed outside the measurement range.

Reference »» Refer to 4-3-4 Zero Reset Function.

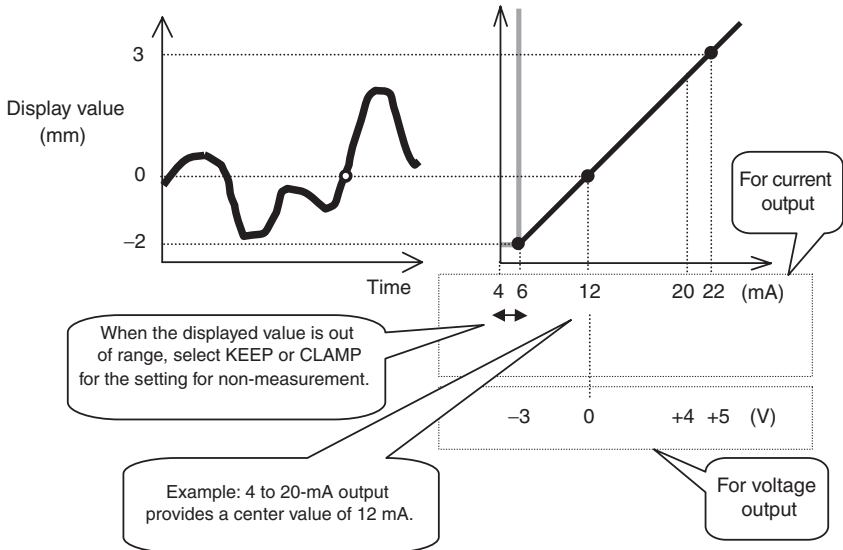
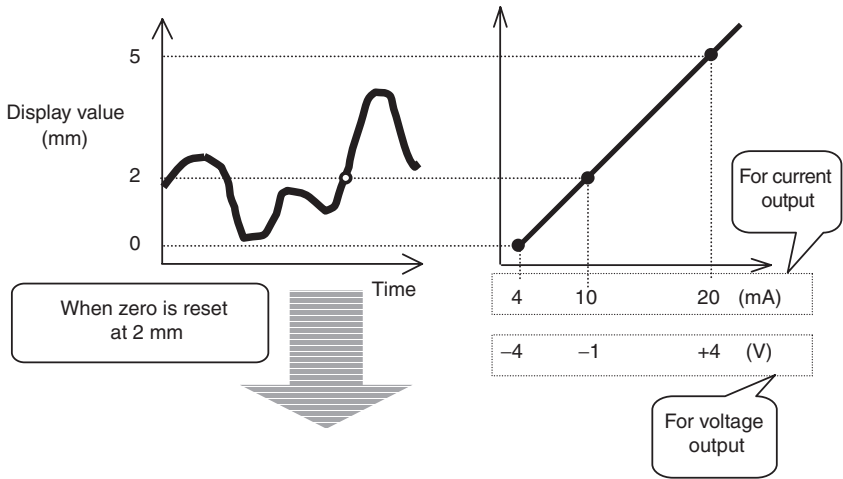

Changes in Display Value and Linear Output for Zero Reset

Example: Use Zero Reset to Evaluate the Height of a Step in the Sensing Object

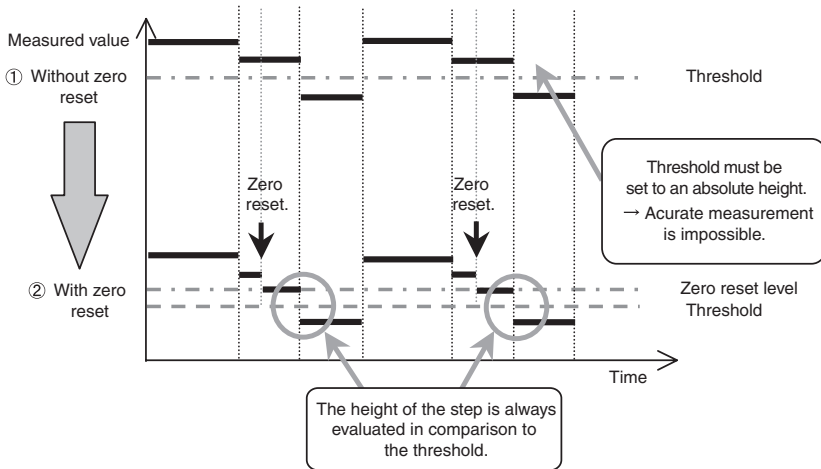
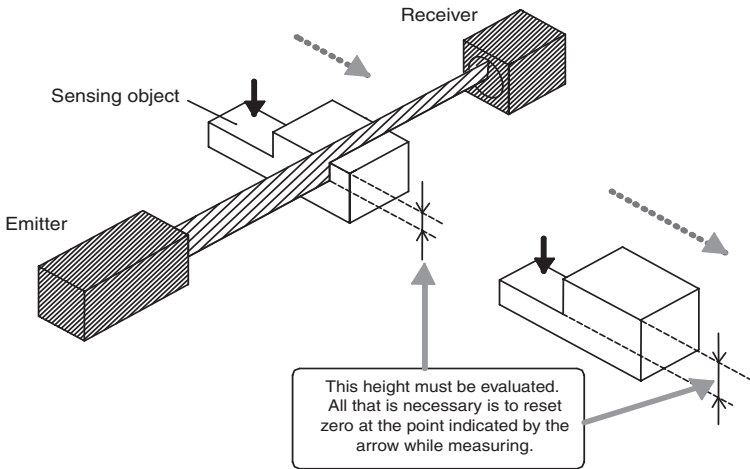

In this case, disabling the zero reset memory is recommended.

Reference >> Refer to 3-8-15 Zero Reset Memory Function.

3-7 Through-beam Sensor Heads: T Mode Functions

3-7-1 Teaching

“Teaching” is used to perform calculations in the Sensor to automatically determine the threshold values by creating an actual operating environment and detecting objects. After teaching, the threshold values can be precisely adjusted or teaching can be performed as many times as required.

There are three kinds of teaching: Position teaching, two-point teaching, and automatic teaching.

Reference » Refer to 4-4-1 Teaching Procedures.

■ Position Teaching

When teaching is executed, the measured value is set as a threshold.

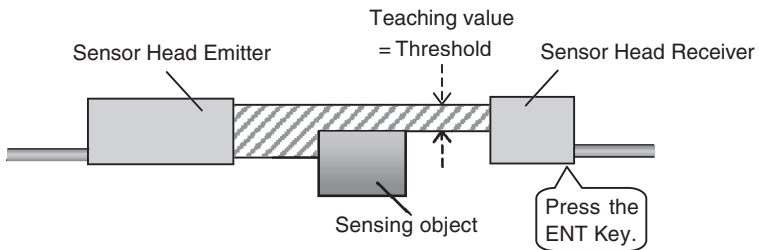

Example: Position Teaching

■ Two-point Teaching

The middle point between the first teaching point and the second point is set as a threshold. With two-point teaching, small steps, such as a sheet of paper, can be measured.

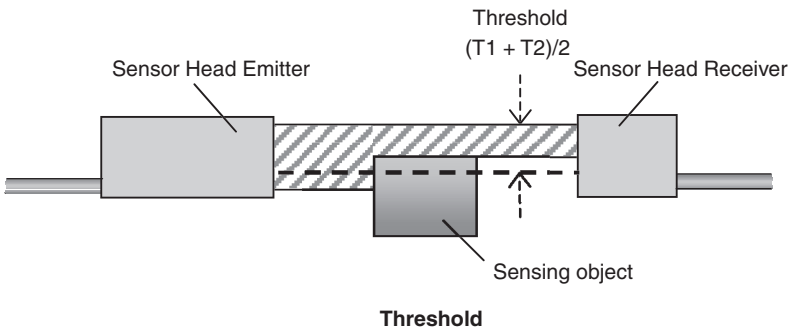
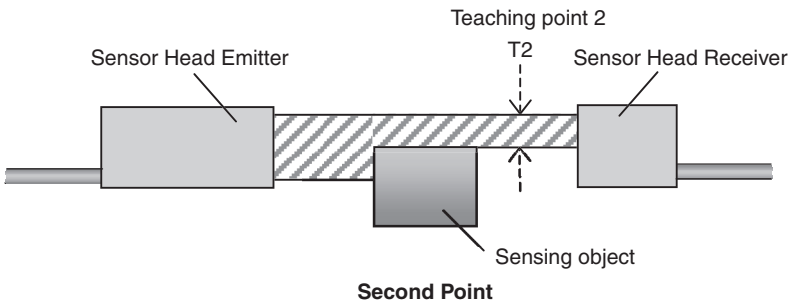
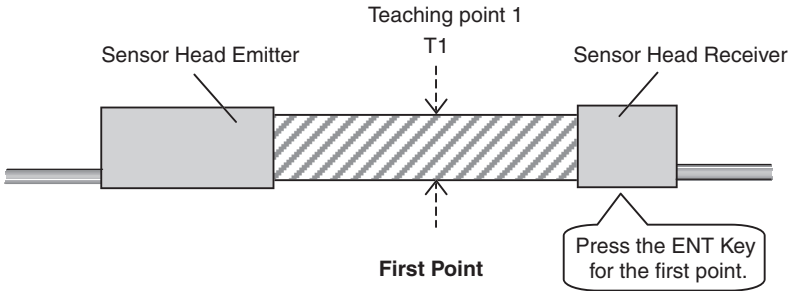

Example: Two-point Teaching

■ Automatic Teaching

For automatic teaching, measurements are performed while the RIGHT Key and the ENT Key are pressed at the same time. The center value between maximum and minimum values is set as a threshold.

The threshold value is set when the keys are released.

The threshold can be set according to the sensing object.

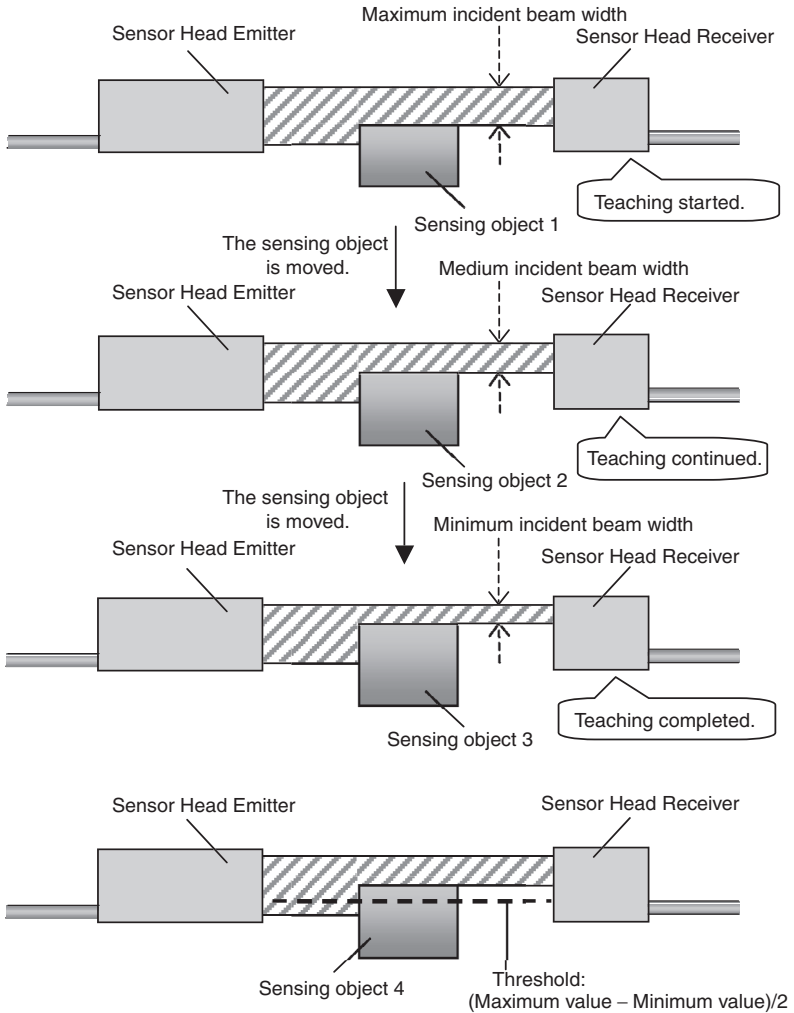

Example: Automatic Teaching

3-7-2 Inputting Threshold Values Directly

The threshold values can be directly input into the sub-display.

Note: Generally, any value can be input. The judgement outputs, however, will not operate for thresholds that are outside the measurement range. Also, the decimal point cannot be changed.

Reference » **If an error occurs when inputting a threshold value, refer to 4-4-2 *Inputting Threshold Values Directly* and 5-2-3 *Unable to Set Threshold Values*.**

3-8 Through-beam Sensor Heads: FUN Mode Functions

3-8-1 Auto-scaling

Select either millimeters or a percentage for the display on the main display and whether the incident level or intercepted amount is displayed.

The current incident level (intercepted amount) is automatically scaled, displayed, and output with respect to the reference incident level.

The default display setting is 100-L.

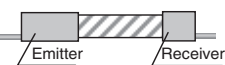
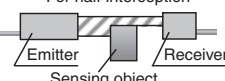
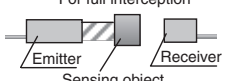
		5-L	5-d	10-L	10-d	30-L	30-d	100-L	100-d
For no interception 	Display	5.000	0.000	10.000	0.000	30.000	0.000	100.00	0.00
	Linear output	+4 V 20 mA	-4 V 4 mA	+4 V 20 mA	-4 V 4 mA	+4 V 20 mA	-4 V 4 mA	+4 V 20 mA	-4 V 4 mA
For half interception 	Display	2.500	2.500	5.000	5.000	15.000	15.000	50.000	50.000
	Linear output	0 V 12 mA	0 V 12 mA	0 V 12 mA	0 V 12 mA	0 V 12 mA	0 V 12 mA	0 V 12 mA	0 V 12 mA
For full interception 	Display	0.000	5.000	0.000	10.00 0	0.000	30.000	0.00	100.00
	Linear output	-4 V 4 mA	+4 V 20 mA	-4 V 4 mA	+4 V 20 mA	-4 V 4 mA	+4 V 20 mA	-4 V 4 mA	+4 V 20 mA

- Note**
1. When 100-L or 100-d is selected, the incident level is displayed as a percentage.
 2. The above table shows values when the monitor focus function is not used.
 3. When scaling for values other than 5, 10, or 30 mm, use the 2-point scaling function.
 4. Set the monitor focus after the auto-scale setting.

Reference » Refer to *4-5-13 Auto-scale Settings* for the setting procedure.

Note: When the auto-scale function is set, all settings are automatically reset to their default values.

3-8-2 Scaling

Scaling is used to arbitrarily change the display value for the measured value. The display value for any measured value can be input or changed.

When scaling one point, the display value offset is changed; the display value range is not changed. When scaling two points, both the range and offset of display values are changed.

One-point Scaling

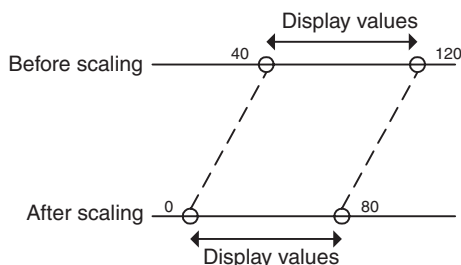

Although the range cannot be changed, the offset can be changed.

Two-point Scaling

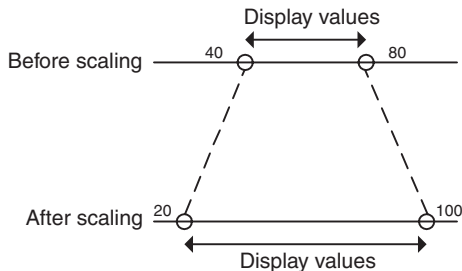

The range and offset can be changed.

Reference » Refer to *4-5-7 Setting Scaling*.

Note: The display values for measured values change when a scaling is set, but the linear output values will remain unchanged. The relation between measured values and linear output values is set with the monitor focus function. To alter the output values, set the monitor focus after setting scaling.

Reference » Refer to *3-5-8 Monitor Focus Function*.

● Inverting Display Values

When inverting the display values is set, the display values will be in an inverse relationship to the reference values.

Normally, the more the measured value between Sensor and sensing object increases, the larger the display value becomes. However, if the display values are inverted, the more the measured value increases, the smaller the display value will become.

Inverting display values is not possible when two-point scaling is used.



When any of the following changes is performed, the scaling function is automatically cleared and must be performed again.

- Turning ON or OFF Intensity Mode.
- Enabling or disabling two-sensor operation A + B.
- Enabling or disabling two-sensor operation A – B.

Reference »» When scaling cannot be set correctly, refer to **5-2-1 Unable to Set Scaling.**

■ **Offsetting Display Values: One-point Scaling A**

Use one-point scaling to offset the display values. Input the width to be displayed for the current measurement point.

When you input only one point for scaling, only the offset is changed without changing the range of display values. In this example, the display values are not inverted.

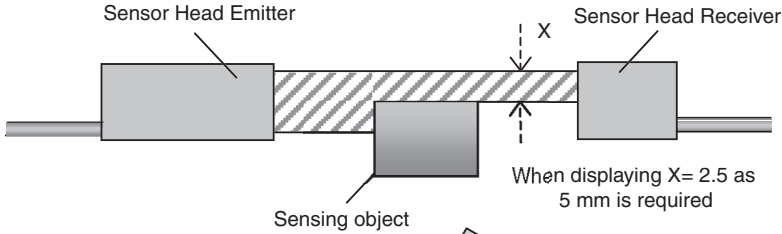

Then,

Before scaling	After scaling	
Measured value = Display value	Display value	Measured value
1.5	4.0	1.5
2.0	4.5	2.0
2.5	5.0	2.5
3.0	5.5	3.0

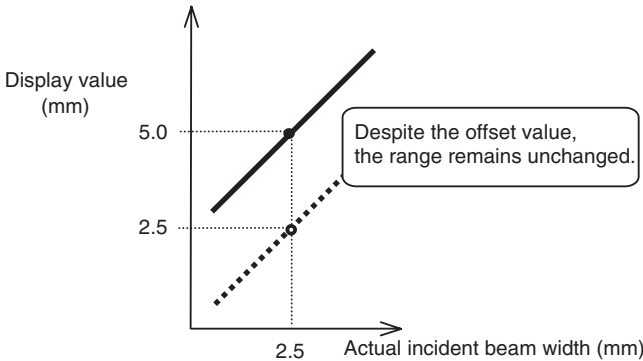

Example: One-point Scaling A

■ **Correcting Display Values to Match Actual Width: Two-point Scaling A**

Display values can be corrected if there is a discrepancy between the actual incident beam width and the value displayed on the Amplifier Unit. When actual widths are known, they are input at two points to correct the range and offset of display values (see following figure).

Reference » To change only the offset without changing the range of display values, refer to ■ **Offsetting Display Values: One-point Scaling A.**

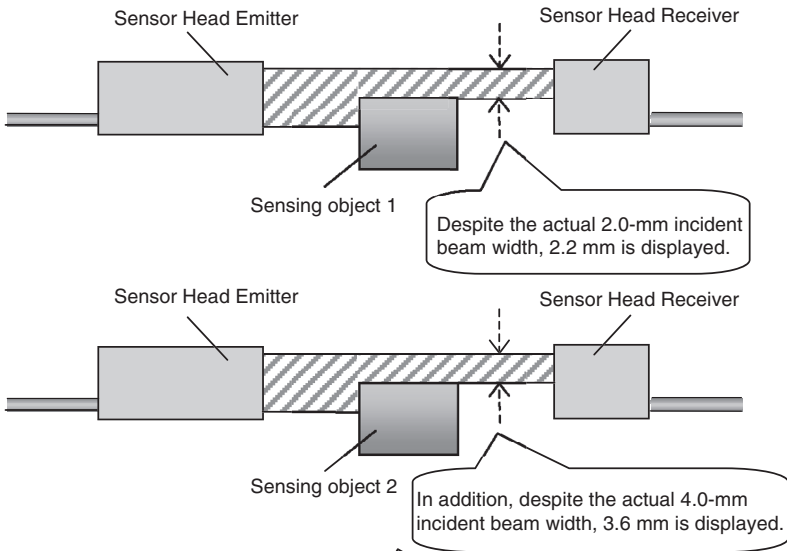

In this case:

: Scaling value inputs

Before scaling		After scaling		
Actual incident beam width	Measured value = Display value	Actual incident beam width	Display value	Measured value
2.0	2.20	2.0	2.0	2.20
2.5	2.55	2.5	2.5	2.55
3.0	2.90	3.0	3.0	2.90
3.5	3.25	3.5	3.5	3.25
4.0	3.60	4.0	4.0	3.60

There are discrepancies between actual incident beam width and display values.

Correct them to match.

Example: Two-point Scaling A

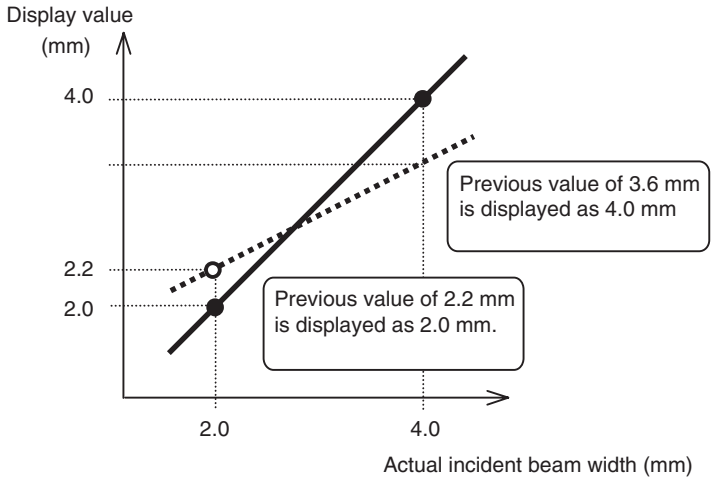

■ **Displaying Arbitrary Values: Two-point Scaling B**

Any display value can be achieved using the same method as for the two-point scaling A. Any value can be input for two points to change the range and offset of display values (see following figure).

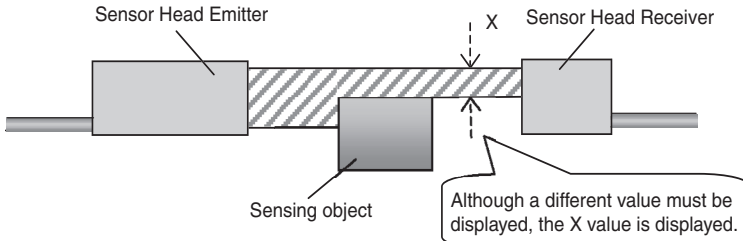

If 120 mm must be displayed for $X_1 = 2$ mm and 80 mm must be displayed for $X_2 = 4$ mm,

Then,

Before scaling	After scaling	
Measured value = Display value	Display value	Measured value
2.0	120.0	2.0
3.0	100.0	3.0
4.0	80.0	4.0
5.0	60.0	5.0

2.0 mm and 4.0 mm are displayed as 120 mm and 80 mm, respectively.

Both the display range and offset are changed.

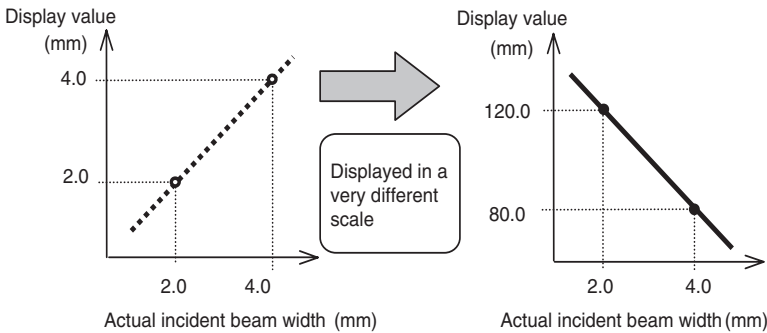

Example: Two-point Scaling B

■ **Displaying the Width of the Sensing Object: One-point Scaling B**

The width of the sensing object can be measured by using two-sensor operation and one-point scaling, and inverting the display values.

First, perform the two-sensor operation A+B to display the sum of the measured values for the two Sensor Heads.

Reference ➤ **Refer to 3-8-7 Two-sensor Operation.**

Second, set the actual sensing object and set the values to be displayed in scaling mode.

When selecting the incident level display (L) for auto-scaling, enable inverting display values for the scaling mode so that smaller values are displayed when larger intercepted beam widths are measured at the Sensor Head (i.e., when thinner intercepted beam widths are measured).

When the widths of two sensing objects are known, two-point scaling can also be used.

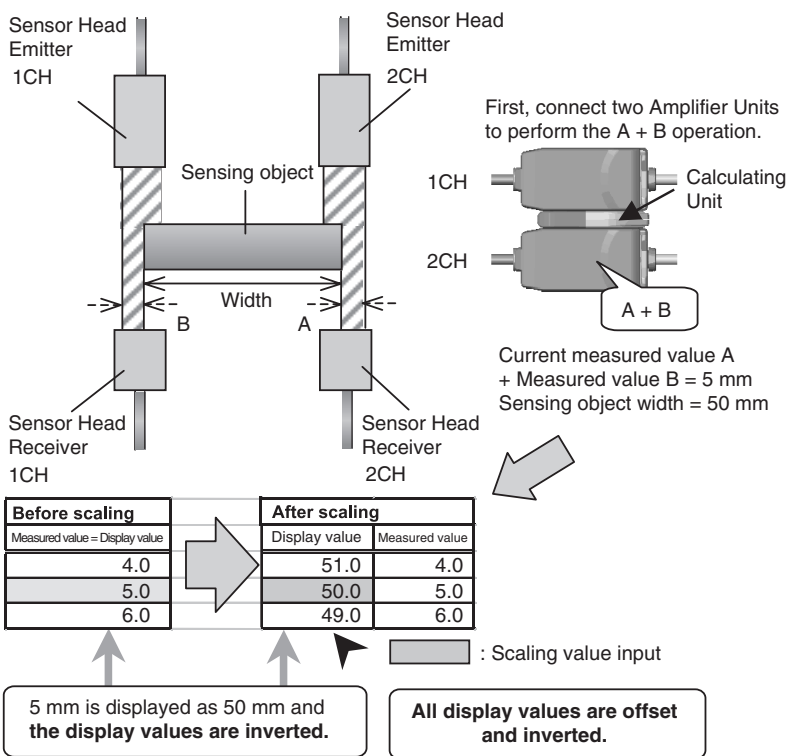

Example: One-point Scaling B

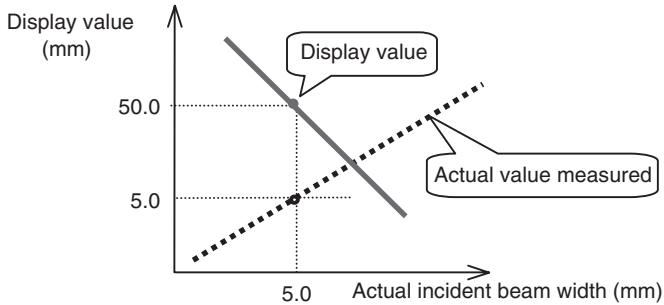

3-8-3 Number of Samples to Average

The number of samples to average is the number of data points used to average data measured by the Sensor.

Increase the number of samples to average to decrease variations in order to achieve fine positioning and judgement. If the number of samples is increased, however, the response time of the judgement outputs and linear output will be increased.

The following table shows the relationship between the number of samples to average and the response time.

Number of samples to average	Response time (ms)
1	0.3
2	0.5
4	0.8
8	1.5
16	2.5
32	5
64	10
128	20
256	40
512	75
1,024	150
2,048	300
4,096	600

Number of Samples to Average and Response Time

Note: When the number of samples to average is increased n times, the resolution is generally improved \sqrt{n} times.

Reference » Refer to 4-5-12 Other Special FUN Mode Settings.

3-8-4 Hysteresis Setting

The hysteresis of the threshold values (hysteresis width) can be set. Any value can be input directly or the hysteresis can be set automatically.

Reference » Refer to *4-5-6 FUN Mode Status Transitions*.

Reference » **If the hysteresis cannot be set, refer to *5-2-4 Unable to Set Hysteresis*.**

When the hysteresis is set automatically, the hysteresis width is almost equal to the resolution.

3-8-5 Hold Functions

The hold functions extract, output, and display data for specific points, such as the maximum value, the minimum value, etc.

There are six hold functions: Peak hold, bottom hold, sample hold, peak-to-peak hold, self-peak hold, and self-bottom hold.

Reference » Refer to 4-5-6 FUN Mode Status Transitions.

Reference » Refer to ■ Judgement Outputs in Hold Mode for information on the judgement outputs when using a Hold Mode.

Note: The following notes apply to Hold Mode.

- (1) The zero reset input is disabled while sampling (i.e., while the timing input is ON) in Hold Mode or while - - - - is displayed on the main display.
- (2) When non-measurement status occurs (i.e., the reset input turns ON or a reception error occurs) during sampling (i.e., while the timing input is ON) in Hold Mode, the extracted data will be discarded. Sampling continues until the timing input is turned OFF. When an incident level error occurs continuously during the sampling, "Error" is displayed when holding.
- (3) The timing input does not affect sampling during the self-peak hold or the self-bottom hold.
- (4) Do not enable the timer in Hold Mode.

■ Normal Mode (Hold Not Enabled)

In Normal Mode, the measured value is always displayed and output. The timing input is disabled and no hold function will operate.

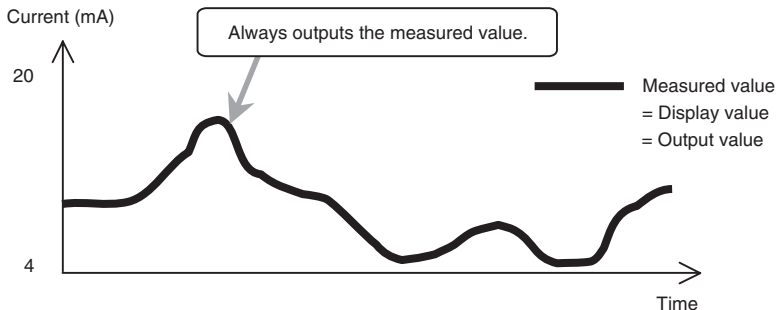

■ Peak Hold

In Peak Hold Mode, measurements are performed while the timing input is ON, and the maximum value during the sampling period will be the output value.

Hold Mode starts when the power is turned ON, immediately after changing to RUN or T Mode, or immediately after the reset input is turned OFF.

The output is held at the maximum output (current: approximately 23 mA, voltage: approximately 5.5 V) until the first sampling period is finished. The first measured result (A in the figure below) is output from the end of the first sampling period to the end of the second sampling period. After the second sampling period, the second measured result (B in the figure below) is output and the sequence is repeated.

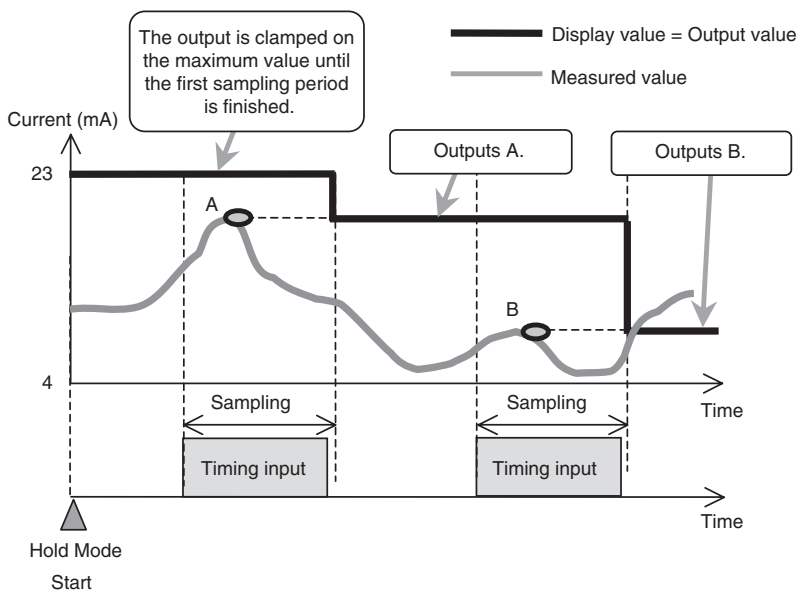

Example: Peak hold

■ Bottom Hold

In Bottom Hold Mode, measurements are performed while the timing input is ON, and the minimum value during the sampling period will be the output value.

Hold Mode starts when the power is turned ON, immediately after changing to RUN or T Mode, or immediately after the reset input is turned OFF.

The output is held at the maximum output (current: approximately 23 mA, voltage: approximately 5.5 V) until the first sampling period is finished. The first measured result (A in the figure below) is output from the end of the first sampling period to the end of the second sampling period. After the second sampling period, the second measured result (B in the figure below) is output and the sequence is repeated.

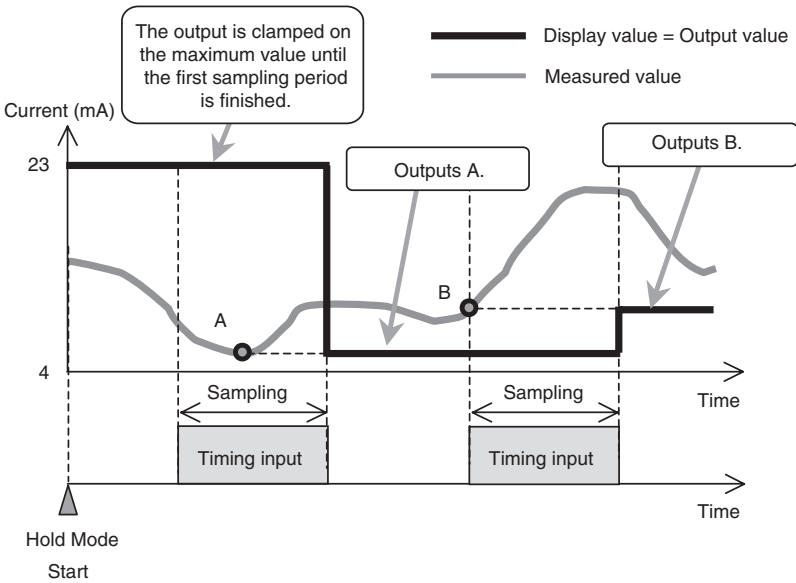

Example: Bottom Hold

■ **Sample Hold**

In Sample Hold Mode, the measured result when the timing input is turned ON will be the output value.

Hold Mode starts when the power is turned ON, immediately after changing to RUN or T Mode, or immediately after the reset input is turned OFF.

The output is held at the maximum output (current: approximately 23 mA, voltage: approximately 5.5 V) until the first time the timing input turns ON. The first measured result (A in the figure below) is output from the beginning of the first sampling period to the second sampling period. After the beginning of the second sampling period, the second measured result (B in the figure below) is output and the sequence is repeated.

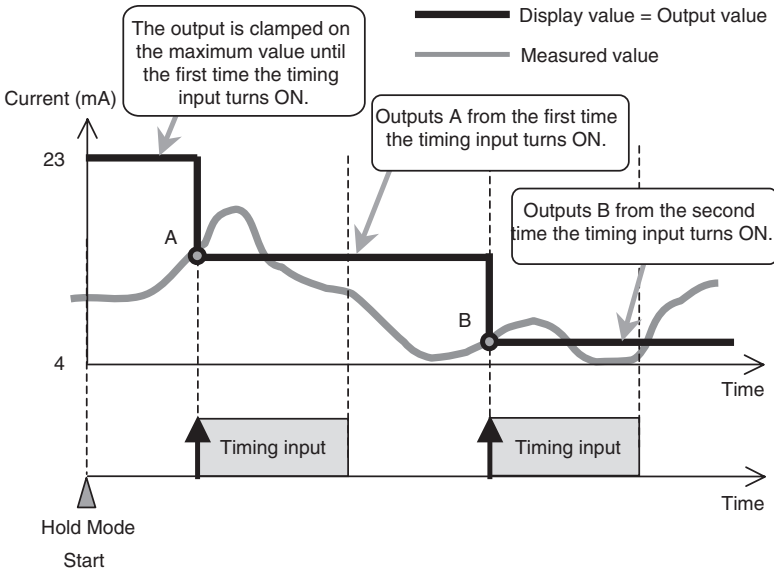

Example: Sample Hold

■ Peak-to-peak Hold

In Peak-to-peak Hold Mode, measurements are performed while the timing input is ON, and the difference between the maximum value and the minimum value in the sampling period will be the output value.

Hold Mode starts when the power is turned ON, immediately after changing to RUN or T Mode, or immediately after the reset input is turned OFF.

The output is held at the maximum output (current: approximately 23 mA, voltage: approximately 5.5 V) until the first sampling period is finished. The first measured result ($P_1 - B_1$ in the figure below) is output from the end of the first sampling period to the end of the second sampling period. After the second sampling period, the second measured result ($P_2 - B_2$ in the figure below) is output and the sequence is repeated.

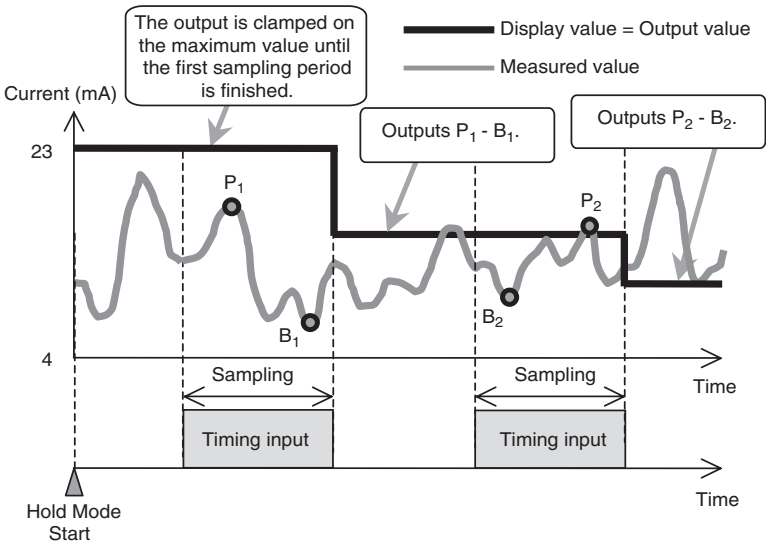

Example: Peak-to-peak Hold

■ Self-peak Hold

In Self-peak Hold Mode, measurements are performed while the measured value is larger than or equal to the self-trigger level, and the maximum value in the period will be the output value.

Hold Mode starts when the power is turned ON, immediately after changing to RUN or T Mode, or immediately after the reset input is turned OFF.

The output is held at the maximum output (current: approximately 23 mA, voltage: approximately 5.5 V) until the first sampling period is finished. The first measured result (A in the figure below) is output from the end of the first sampling period to the end of the second sampling period. After the second sampling period, the second measured result (B in the figure below) is output and the sequence is repeated.

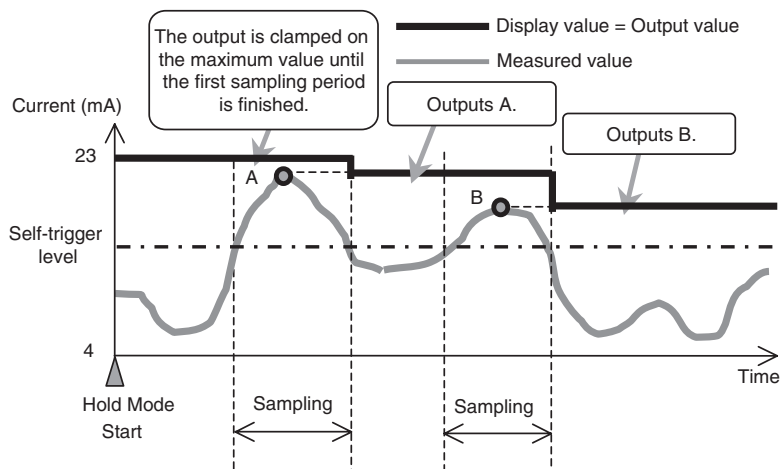

Example: Self-peak Hold

● Self-trigger Level

The self-trigger level is the threshold value for which measured value sampling is performed. In Self-peak Hold Mode, sampling starts when the measured value becomes larger than or equal to this value and sampling ends when the measured value becomes smaller than or equal to this value. The maximum value during this period is the hold value.

In Self-bottom Hold Mode, sampling starts when the measured value becomes smaller than or equal to this value and sampling ends when the measured value becomes larger than or equal to this value. The minimum value during this period is the hold value.

Note: Hysteresis (hysteresis width) is applied to the self-trigger level. The hysteresis is generated when sampling ends ($\pm 3\%$ FS).

■ Self-bottom Hold

In Self-bottom Hold Mode, measurements are performed while the measured value is smaller than or equal to the self-trigger level, and the minimum value in the period will be the output value.

Hold Mode starts when the power is turned ON, immediately after changing to RUN or T Mode, or immediately after the reset input is turned OFF.

The output is held at the maximum output (current: approximately 23 mA, voltage: approximately 5.5 V) until the first sampling period is finished. The first measured result (A in the figure below) is output from the end of the first sampling period to the end of the second sampling period. After the second sampling period, the second measured result (B in the figure below) is output and the sequence is repeated.



Sampling is not affected by the timing input in Self-bottom Hold Mode.

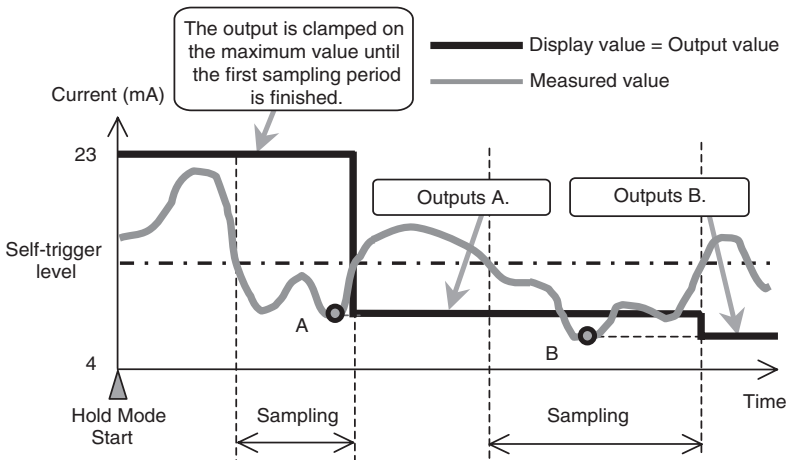

Example: Self-bottom Hold

■ Judgement Outputs in Hold Mode

The judgement outputs during Hold Mode are based on the value that is held (= display value). Therefore, when using Hold Mode, the linear output, judgement outputs, and display value remain unchanged before the end of the next sampling period. The other status is as follows from when Hold Mode is started until the first hold value is determined:

- Linear output: Clamped on the maximum output.
- Judgement outputs: All OFF
- Main display: -----



Sampling is not affected by the timing input in Self-peak Hold Mode.

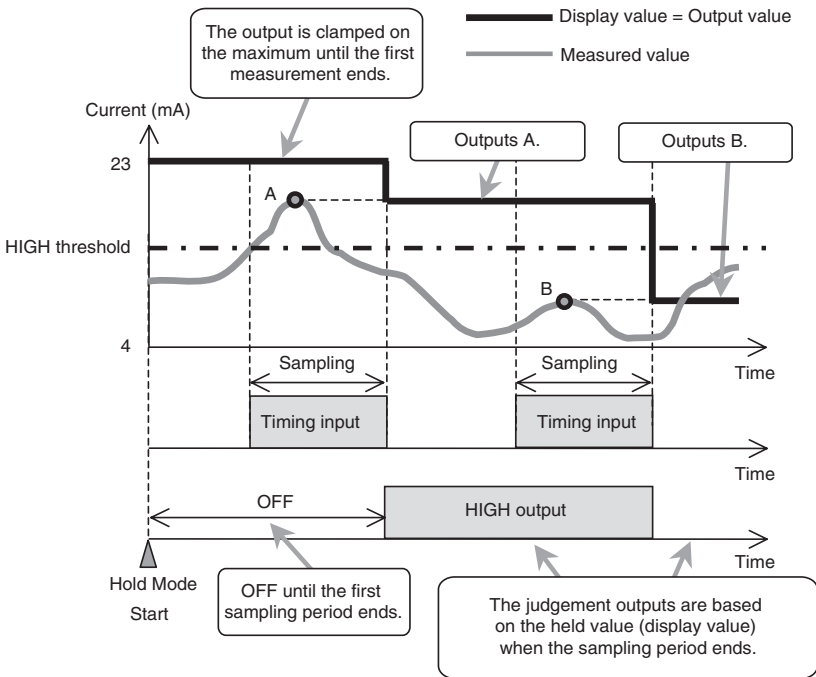

Example: Judgement Outputs during Peak Hold

3-8-6 Timer

■ Timer Time

The time set for the timer is the delay time for the ON-delay timer, the delay time for the OFF-delay timer, or the pulse width for the one-shot timer. Set the time according to the requirements of the control system (e.g., PLC). The timer time can be set to between 0 and 5,999 ms.

■ Timer Disable

If the timer is disabled, judgement outputs will be made immediately and the output response time will be determined by the number of samples to average.

■ OFF-delay Timer

When the measured value changes from HIGH to PASS or from LOW to PASS, turning OFF the PASS output is delayed for the timer time.

■ ON-delay Timer

When the measured value changes from HIGH to PASS or from LOW to PASS, turning ON the PASS output is delayed for the timer time.

■ One-shot Timer

When the measured value changes from HIGH to PASS or from LOW to PASS, the PASS output is turn ON with a pulse width equivalent to the timer time.

When PASS output pulses overlap, the latter pulse has priority. Therefore, overlapping pulses might sometimes become a single pulse rather than separate pulses.

Note: Neither the HIGH nor the LOW output are output when the one-shot timer is selected.

Reference ►► Refer to *4-5-6 FUN Mode Status Transitions*.

The timing chart is shown below.

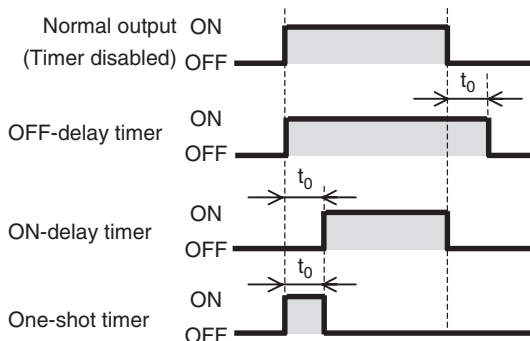

Changes for Different Types of Timer and PASS Output (Timer Time: t_0)

The timer process is applied to the PASS output. This means that an ON-delay timer of t_0 is applied to the HIGH output when the OFF-delay timer of t_0 is applied to the PASS output when the measured value changes from PASS to HIGH as shown in the following figure.

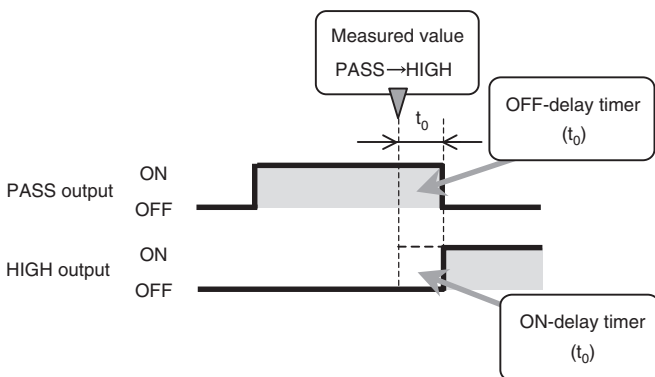

Delay Timer Applied to PASS Output

Example: OFF-delay Timer (t_0) Going from PASS to HIGH

3-8-7 Two-sensor Operation

Two-sensor operation enables mutual operation using the measured values from the two Sensor Heads to generate final outputs. Two kinds of outputs, A-B or A+B, can then be selected.



When two-sensor operation is selected, any scaling that is set for each Sensor Head will be reset to the default. When scaling is required during two-sensor operation, perform scaling after enabling two-sensor operation.



When setting the Amplifier Units, set the 1CH Amplifier Unit to RUN, then perform the settings for the 2CH Amplifier Unit.

Note: The ranges of display values and linear output values are automatically doubled when two-sensor operation is used. An example application of Sensor Heads is given in the following table when the width is 5 mm.

Linear output	4 to 20 mA
A - B	-5 to 5
A + B	0 to 10

Note: Correct distance operation cannot be performed if Sensor Heads with different sensing distances are used.

■ A – B

The difference between the measured values of the two Sensor Heads is the final output. The measured value of the 1CH Amplifier Unit is B and the measured value of the 2CH Amplifier Unit is A.

■ A + B

The sum of measured values of the two Sensor Heads is the final output. The measured value of the 1CH Amplifier Unit is B and the measured value of the 2CH Amplifier Unit is A.

■ Operation Result Output

The result of the operation is displayed on and output from the 2CH Amplifier Unit. The B measured value is displayed on and output from the 1CH Amplifier Unit.



When sensing object thickness measurement is required, change the display value using the scaling function after selecting the A + B operation

Reference » Refer to *3-8-2 Scaling*.

3-8-8 Initializing Settings

All setting conditions can be initialized. Special settings, such as for the monitor focus function and the scaling function, are also initialized.

Note: Once initialized, the settings cannot be reset to the previous ones. Keep in mind that all settings must be made from the beginning if required settings are inadvertently initialized.

● Default Settings

The settings are initialized to the default setting made at the factory. The default settings are listed in the following table.

Mode	Function	Initial value
FUN	Scaling values	OFF
	Number of samples to average	32 samples
	Hysteresis	0.5% of full scale (FS)
	Hold	OFF (disabled)
	Timer	OFF (disabled)
	Two-sensor operation (when two Amplifier Units are connected)	OFF (disabled)
	Special selection	CLOSE
	Monitor focus function	4 V (20 mA): Maximum sensing distance -4 V (4 mA): Minimum sensing distance
	Differentiation function	OFF (disabled)
	Display reverse function	OFF (disabled)
	ECO display function	OFF (disabled)
	Limited number of display digits	All digits displayed
	Settings for non-measurement	KEEP
	Zero reset memory function	ON
	Gain switch	METAL
Auto-scale value	100-L	
T	H threshold value	100.00
	L threshold value	0.00
RUN	Sub-display function	Threshold values
	Reference incident level setting	Not set
	Zero reset function	OFF (invalid)

Reference ►► Refer to 4-5-8 *Initializing Settings*.

3-8-9 Monitor Focus Function

The linear output range and inclination for display values can be specified. These are set by defining two output values for specified display values.



The monitor focus should be set after scaling. It is recommended that you first confirm the display value for the actual distance (or width) from scaling, then determine the linear output value that corresponds to that display value.

Reference » Refer to 4-5-10 *Setting the Monitor Focus*.

Reference » When the monitor focus function cannot be set correctly, refer to 5-2-2 *Unable to Set Monitor Focus*.

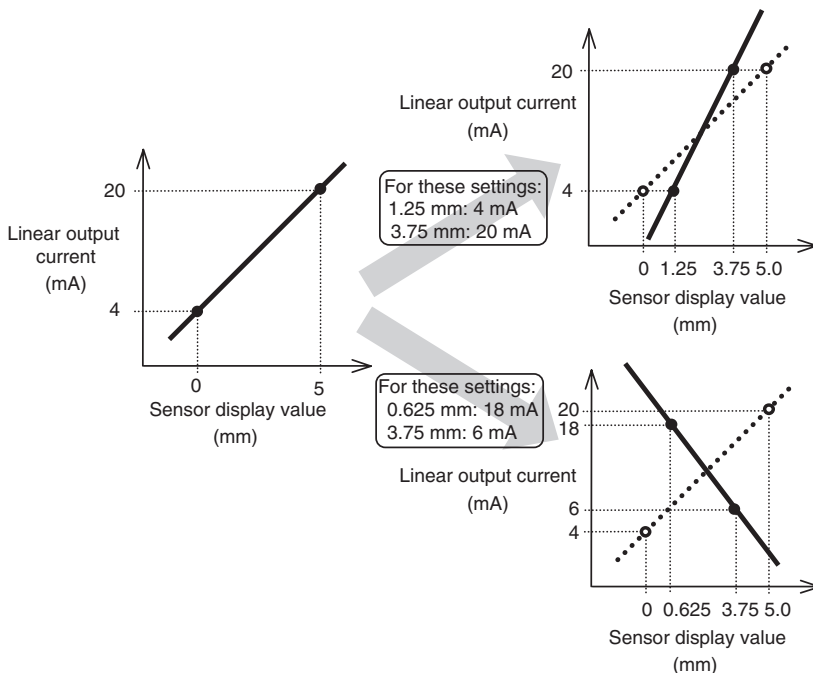

Examples: Monitor Focus 1

Note: The zero reset is automatically cleared when the monitor focus is set.

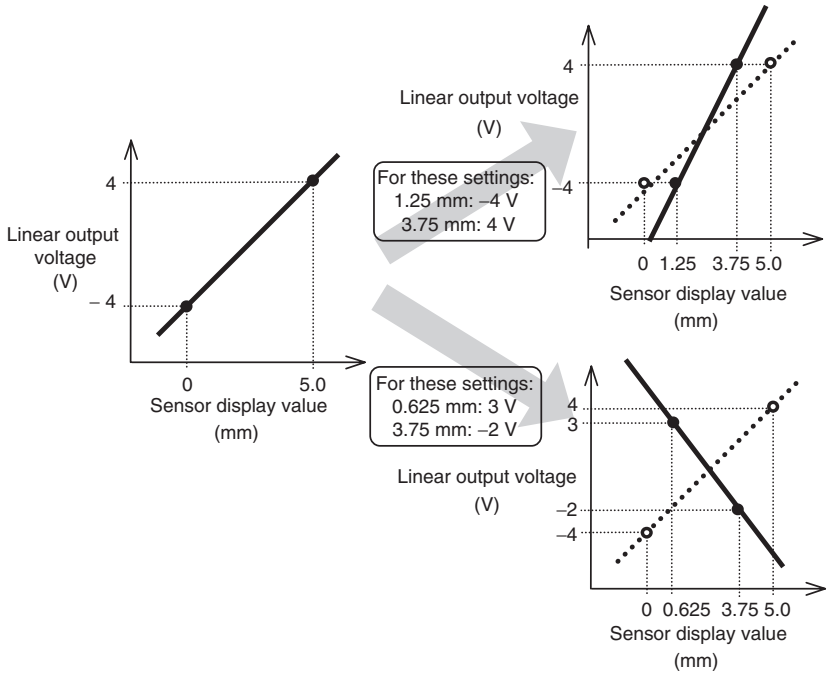

Examples: Monitor Focus 2

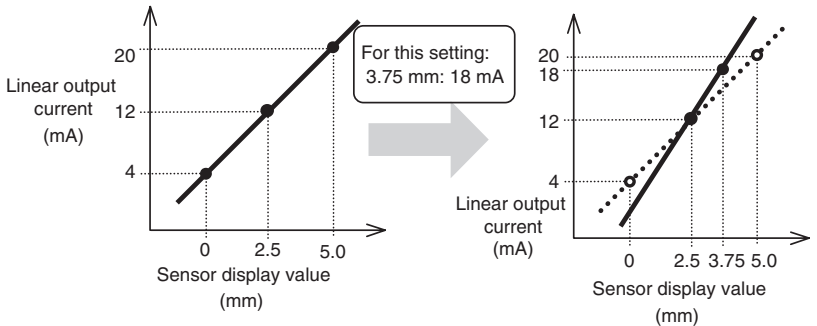

Examples: Monitor Focus 3, Enabling Differentiation

3-8-10 Differentiation Function

The differentiation function is used to convert variations in measured values into output values. Use it for measurements that monitor changes in measured values, such as counting the number of sheets.

When the Differentiation Mode is enabled, the number of cycles (measurement period) to be compared can be set. (1 cycle: 150 μ s)

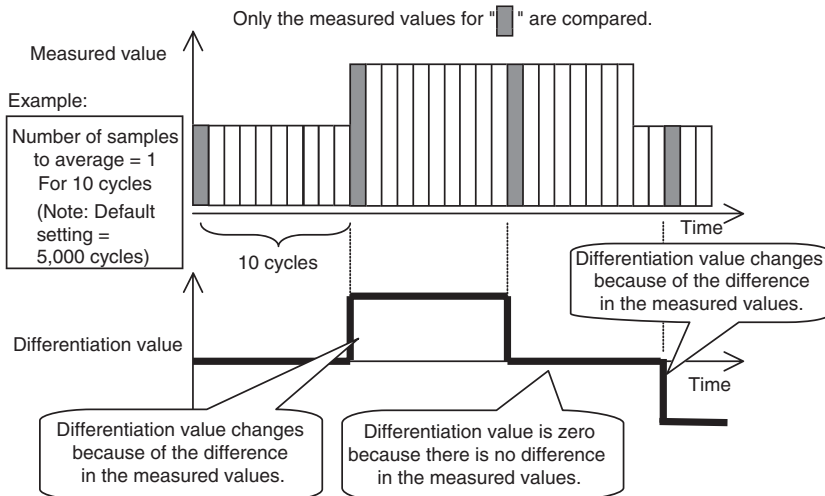

Example: Measured Values and Differentiation Values



The variation in the measured values indicates the difference between the previous and current measured values. This value will decrease when the number of samples to average is increased.

3-8-11 Display Reverse Function

The display direction of the digital displays can be selected. Select either forward or backward according to the mounting direction of the Amplifier Unit.

Reference » Refer to *4-5-11 Special FUN Mode Settings Related to Displays*.

3-8-12 ECO Display Function

The ECO display function can be enabled or disabled. When the ECO display function is enabled, the digital display will not light.

3-8-13 Limiting the Number of Display Digits

The number of display digits of the main display and sub-display can be set. When the number of digits is reduced, the lowest digit is disabled first. In addition, if 0 digits are specified, the entire digital display is disabled. This applies, however, only in RUN Mode.

3-8-14 Setting for Non-measurement

The output method used during non-measurement can be set. This setting applies when the reset is input or a reception error occurs.

Outputs	Setting for non-measurement	
	CLAMP	KEEP
Judgement outputs	All OFF.	The status immediately before measurement stopped is held.
Linear output	Held at the maximum output value.	

Maximum output voltage: Approximately 5.5 V

Maximum output current: Approximately 23 mA

Reference » Refer to 4-5-12 Other Special FUN Mode Settings.

3-8-15 Zero Reset Memory Function

If required, the zero reset level can be stored when the power supply is turned OFF. Enable this function when the previous zero reset level must be restored when the power supply is turned ON again.

When this function is enabled, the zero reset level data will be written in nonvolatile memory (EEPROM). The EEPROM can be written a maximum of 100,000 times. Therefore, disable this function in order to preserve the memory when using the zero reset for every measurement.

Even when the zero reset memory function is disabled, the zero reset level will be rewritten to EEPROM at the following times.

- When the threshold values are set.
- When settings are performed in FUN Mode.

3-8-16 Gain Switch

The gain can be set to select the reception sensitivity (corresponds to the internal gain). The gain should normally be set to METAL.

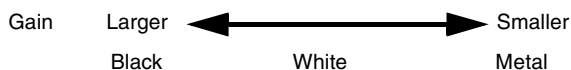

Note: If an appropriate value is not set as the gain for the sensing object color, distance, etc., the output may soon saturate and reach non-measurement status.

3-8-17 Key Lock Function

The keys can be disabled on the Amplifier Unit. Once the keys have been disabled, no key input will be accepted until the lock is released.

Use this function to prevent inadvertent changes to settings.

Reference »» Refer to 4-5-5 Key Lock.

SECTION 4 Operating Procedures

This describes the actual operating procedures and corresponding displays.

4-1 Display Operations.....	108
4-1-1 Displays and Controls.....	108
4-1-2 Indicators.....	109
4-1-3 Controls.....	110
4-2 Initial Display.....	111
4-3 RUN Mode.....	112
4-3-1 Normal Operation.....	112
4-3-2 Changing the Sub-display.....	112
4-3-3 Setting the Reference Incident Level.....	115
4-3-4 Zero Reset Function.....	116
4-3-5 Other RUN Mode Functions.....	117
4-4 T (Threshold) Mode.....	118
4-4-1 Teaching Procedures.....	118
4-4-2 Inputting Threshold Values Directly.....	122
4-5 FUN (Function) Mode.....	124
4-5-1 Normal Operation.....	124
4-5-2 Changing the Function.....	124
4-5-3 Changing Non-numeric Set Values.....	125
4-5-4 Changing Numeric Set Values.....	127
4-5-5 Key Lock.....	131
4-5-6 FUN Mode Status Transitions.....	132
4-5-7 Setting Scaling.....	133
4-5-8 Initializing Settings.....	134
4-5-9 Special FUN Mode Settings Related to Settings.....	135
4-5-10 Setting the Monitor Focus.....	136
4-5-11 Special FUN Mode Settings Related to Displays.....	137
4-5-12 Other Special FUN Mode Settings.....	138
4-5-13 Auto-scale Settings.....	139

4-1 Display Operations

4-1-1 Displays and Controls

The displays, indicators, and control switches on the control panel of the Amplifier Unit are shown below.

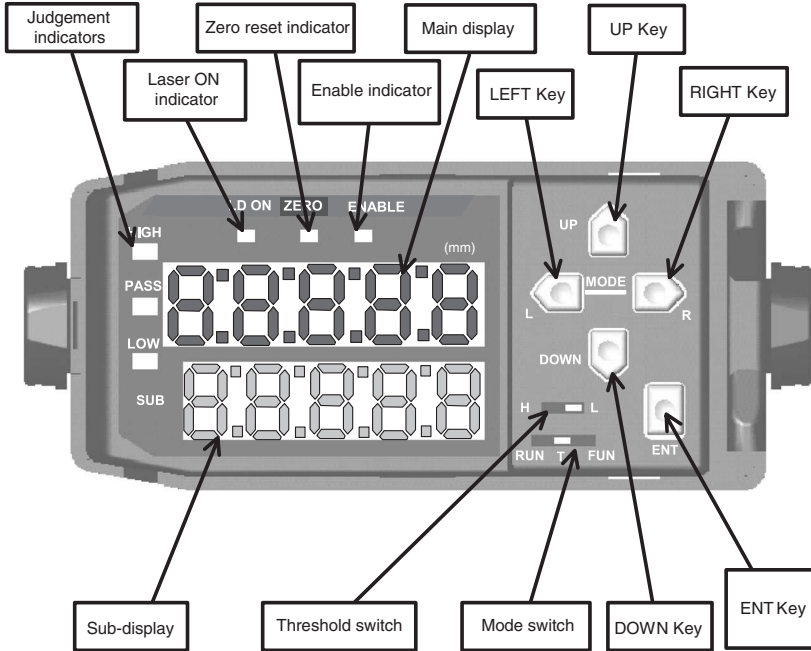

The current/voltage switch is found on the bottom of the Amplifier Unit. (Set to current output when shipped)

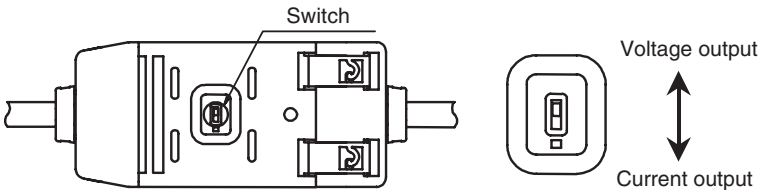

4-1-2 Indicators

Laser ON Indicator: LD ON (Green)

The laser ON indicator is lit when the Sensor Head is emitting a laser beam (Laser Diode: LD).

Judgement Indicators: HIGH (Orange), PASS (Green), and LOW (Yellow)

The judgement indicators light according to the conditions shown below. Each judgement output operates in the same way.

HIGH indicator	...	Measured value > HIGH threshold
PASS indicator	...	LOW threshold ≤ Measured value ≤ HIGH threshold
LOW indicator	...	Measured value < LOW threshold

Main Display: 5-digit Digital Display (Red)

The measured value (mm) is displayed in RUN Mode.

The hold value (mm) is displayed in the Hold Mode.

Characters are displayed upside down in Display Reverse Mode.

Sub-display: 5-digit Digital Display (Yellow)

The resolution or incident level is displayed in RUN Mode.

The threshold values are displayed in T Mode.

Characters are displayed upside down in Display Reverse Mode.

Enable Indicator: ENABLE (Green)

The Enable Indicator is turned ON/OFF according to the following conditions.

ON	...	During normal emission: Measurement enabled.
OFF	...	For non-measurement: Inadequate or excessive incident level, outside the measurement range, or the Sensor Head is not connected at power-ON

Zero Reset Indicator: ZERO (Green)

The zero reset indicator lights when the zero reset function is enabled.

4-1-3 Controls

Mode Switch: RUN, T, or FUN

Any of the following three modes can be selected:

RUN ModeNormal operation mode

T ModeMode for setting the threshold values





FUN modeFunction mode to perform other settings

Threshold Switch: HIGH or LOW

The threshold switch sets the threshold value to be set T or RUN Mode.

Keys

The normal functions of the keys are listed in the following table.

Key	RUN Mode	T Mode	FUN mode
UP 	Timing input	Threshold value changes forward	Function setting value changes forward
DOWN 	Resets input if pressed continuously for 3 seconds	Threshold value changes backward	Function setting value changes backward
RIGHT 	Sub-display content changes forward	Threshold value digit changes forward	Setting function selection moves forward
LEFT 	Sub-display content changes backward	Threshold value digit changes backward	Setting function selection moves backward
ENT 	Pressed continuously for 1 second or longer: Zero reset Pressed continuously with the RIGHT Key for 3 seconds or longer: Zero reset release	Threshold value flashing: Threshold value confirmed. Threshold value lit: Teaching executed.	Setting value flashing (setting): Setting value confirmed Settings initialization: Setting initialized if pressed continuous for a long time.

4-2 Initial Display

When the power is turned ON and initialization has been finished, the display will appear as follows:

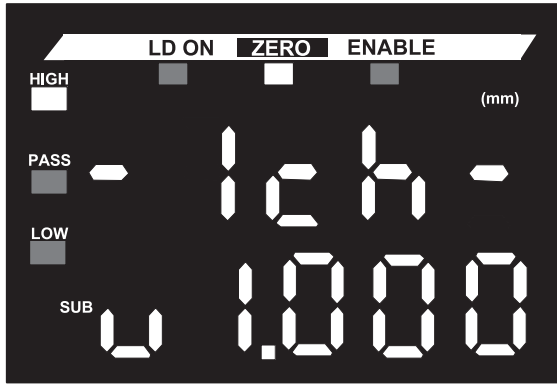

The Amplifier Unit model is displayed on the top, and then the channel number is displayed.

The software version is displayed on the bottom, and then the normal operation display appears 3 seconds later.

4-3 RUN Mode

4-3-1 Normal Operation

The normal measurement process is performed in RUN Mode.

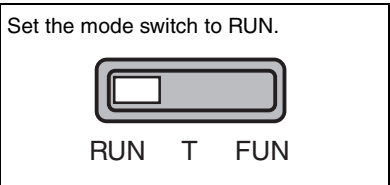
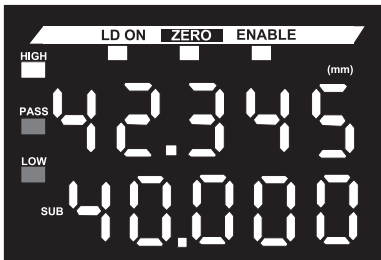

The measured value will be displayed on the main display.

Select the display content for the sub-display from the thresholds, voltage, current, incident level, and resolution.

4-3-2 Changing the Sub-display

The sub-display is changed by pressing the RIGHT and LEFT Keys.

■ **Threshold Display (Default Status)**

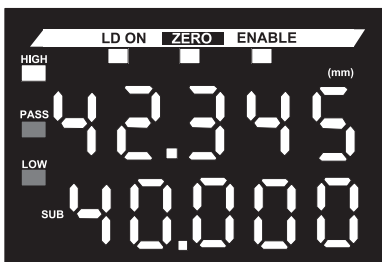

The measured value is displayed on the main display and the threshold value is displayed on the sub-display.

The decimal point is displayed.

Either the HIGH or LOW threshold value is selected using the H/L switch.



The incident level is displayed on the main display in Intensity Mode (incident level, 9999 max.).

■ Voltage Display

The voltage level of the linear output is displayed.

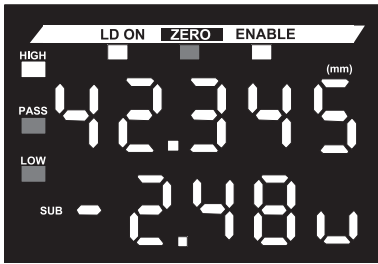

The measured value is displayed on the main display.

The voltage is displayed on the sub-display. "V" is displayed in the rightmost digit.

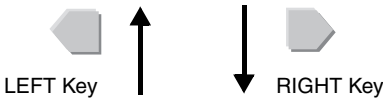

■ Current Display

The current level of the linear output is displayed.

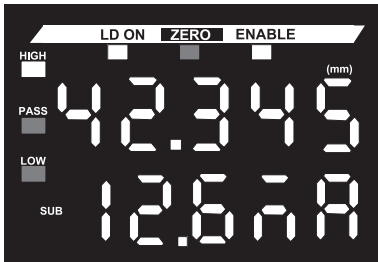

The measured value is displayed on the main display.

The current is displayed on the sub-display. "mA" is displayed in the rightmost two digits.



■ Incident Level Display

The incident level is displayed.



This display cannot be selected in Intensity Mode.

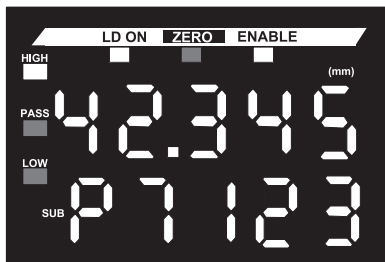

The measured value is displayed on the main display.

The incident level is displayed on the sub-display. The display range is 0 to 9999. "P" is displayed in the leftmost digit. The decimal point is not displayed.

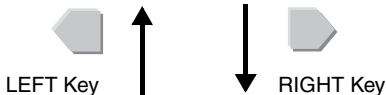

■ Resolution Display

The resolution of the linear output is displayed.

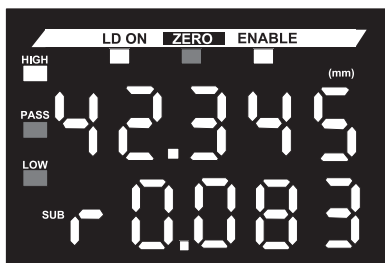

The measured value is displayed on the main display.

The resolution is displayed on the sub-display.

"r" is displayed in the leftmost digit.

The display is updated at an approximately 1-second interval.



The threshold value display is resumed.

4-3-3 Setting the Reference Incident Level

This setting is only for Through-beam Sensor Heads.

The reference incident level can be set and stored using the DOWN Key. The reference incident level set here will be the full scale (FS) value for all measured values.

■ Procedure

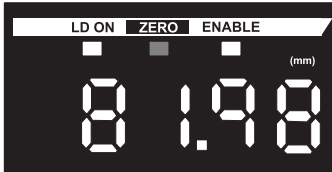

Press the DOWN Key.

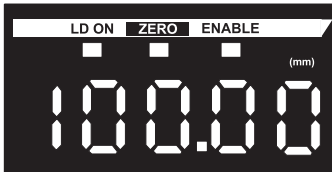

Set the mode switch to RUN.



RUN T FUN

Press the ENT Key for 3 seconds or longer without executing the zero reset.

The full scale (FS) value for when none of the beam is intercepted will be displayed on the main display.

The linear output will be the value set for when none of the beam is intercepted for a two-point setting for the monitor focus.

Note: The reference incident level is stored in the memory. When the power is turned ON the next time, the set reference incident level will be read.

4-3-4 Zero Reset Function

Measured values for the workpiece after the zero display is reset can also be displayed as negative values in reference to the new zero point that is set. The judgement outputs will be based on the display values. The zero reset function is effective when judging tolerances for workpieces.

■ Procedure

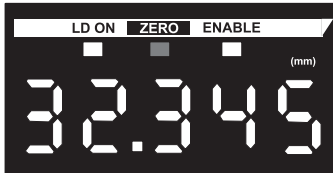

↓ Press the ENT Key.

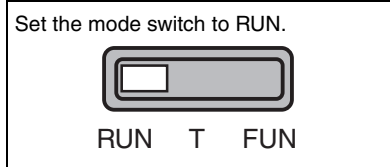
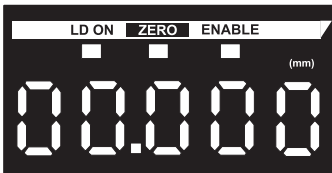

Press the ENT Key for about 1 second or longer without executing the zero reset.

The zero reset can also be performed using the external zero reset input. The operation can be repeated as required.

The main display will be filled with zeros and the zero reset indicator will light.

The linear output will be the center value between the two points that are set for the monitor focus.

Defaults: 0 V, 12 mA



Note 1: Maximum display range on the negative side is -19999 after zero reset.

Note 2: When the zero reset memory function is enabled (it is enabled by default), the zero reset value will be stored.

Note 3: Turn OFF the zero reset memory function when the zero reset is used for every workpiece judgement.

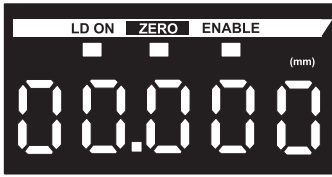
■ Releasing the Zero Reset



 + 
 Hold the ENT and RIGHT Keys down together for about 3 seconds.

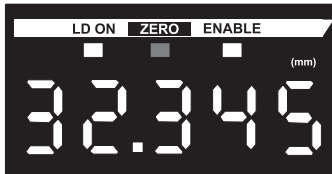

Set the mode switch to RUN.



RUN T FUN

Hold the ENT and RIGHT Keys down together for about 3 seconds when the zero point has been reset.

The zero reset can also be released using the external zero reset input. The operation can be repeated as required.

The previous display will be resumed and the zero reset indicator will turned OFF.

4-3-5 Other RUN Mode Functions

■ Timing Input

The timing input is controlled by pressing the UP Key ().

The timing input is enabled only in Hold Mode.

The timing input can also be controlled using the external timing input.

■ Reset Input

The reset input is controlled by pressing the DOWN Key ().

The reset input is effective when the key is pressed for 3 seconds or longer.

The reset input can also be controlled using the external reset input.

When the reset input is used, operation will be according to setting for non-measurement table in *Reset Input* under *3-2-1 Inputs*.

Reference » Refer to *Reset Input* under *3-2-1 Inputs*.

4-4 T (Threshold) Mode

4-4-1 Teaching Procedures

■ Position Teaching

With position teaching, the threshold values are set based on the values for a workpiece. This teaching method ensures that the measured value will be the ON threshold value after teaching.

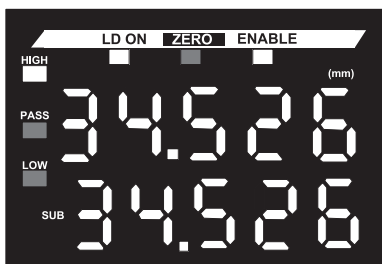
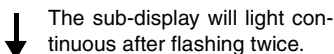
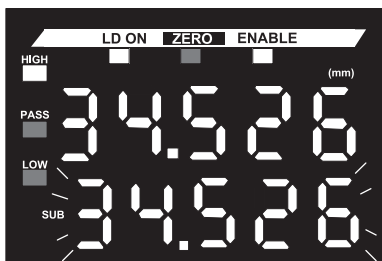
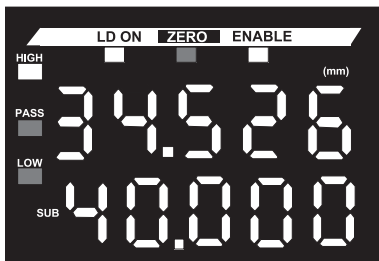

Set the mode switch to T.



RUN T FUN

Select the threshold value that is to be taught using the threshold switch.



Set the workpiece and press the ENT Key for about 1 second while the sub-display is lit.

The measured value of workpiece will be displayed on the sub-display and it will flash twice (all digits will flash together).

The threshold value will be set after the display flashes twice and then lights continuously.

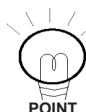

The threshold value will not be modified if a teaching error occurs.

■ Two-point Teaching

Two-point teaching sets the threshold values in the middle between the currently set threshold value and the current measured value.

The workpiece is set in the status where the first point threshold value was set.

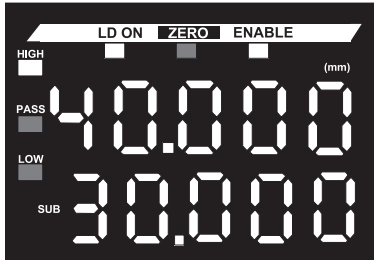

After setting the first point for the threshold value (e.g, after completing position teaching), set the second point for the workpiece by pressing the ENT Key for 3 seconds or longer.



Press the ENT Key for 3 seconds or longer.

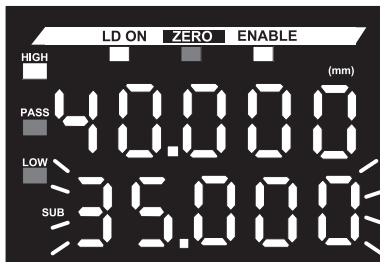

The value in the middle between the first and second points for the workpieces will flash twice on the sub-display.



The sub-display will light continuous after flashing twice.

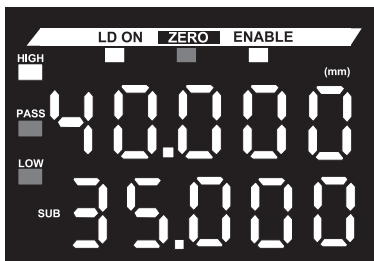

The threshold value will be set after the display flashes twice and then lights continuously.



The threshold value will not be changed if a teaching error occurs.

■ Automatic Teaching

Automatic teaching is used to automatically set the threshold values at optimum positions. The threshold values are automatically set in the middle between the maximum and minimum distance values while the keys are held down.

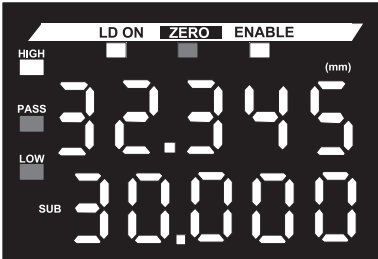

Select the threshold value that is to be taught using the threshold switch.

Press the ENT and RIGHT Keys at the same time as the workpieces flow.

↓

Press the ENT and RIGHT Keys at the same time.

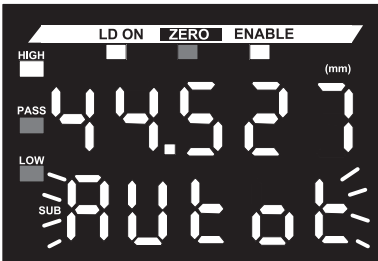

“AUTot” will flash on the sub-display after the keys have been pressed for 1 second (sampling, however, will start immediately after the keys are pressed).
Sampling will continue while the keys are pressed.

↓ Release the keys.

Release the keys.

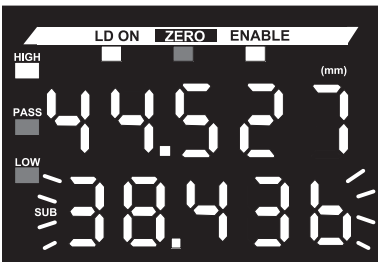

The threshold value will be automatically set when you release the keys. It will be set to the middle position between the maximum and minimum measured for the sample values.
The automatically set threshold value will flash on the sub-display twice.

↓ The sub-display will light continuously after flashing twice.

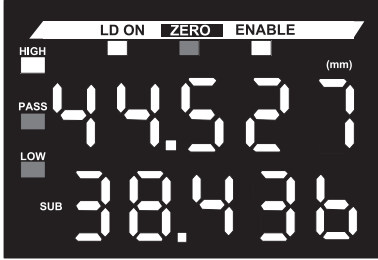

The threshold value will be set after the display flashes twice and then lights continuously.



The threshold value will not be changed while the display is flashing. The measurement process is continued using the previous threshold value.



The threshold value will not be changed if a teaching error occurs.

4-4-2 Inputting Threshold Values Directly

The threshold values can be input directly without using the teaching function. Threshold values can also be fine-tuned after teaching. The measured value is displayed on the main display and the threshold value is displayed on the sub-display.

■ Changing the Numeric Value

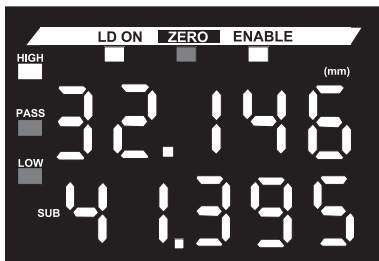

Press the UP, DOWN, RIGHT, or LEFT Key.

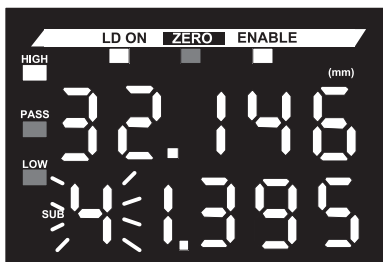

Set the mode switch to T.



RUN T FUN

Select the threshold value that is to be input directly using the threshold switch.

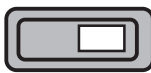

H L

Press the UP, DOWN, RIGHT, or LEFT Key.
Direct input will be started.

The leftmost digit of the threshold value will flash on the sub-display.
Change the numeric value using the procedure shown in the following figure.

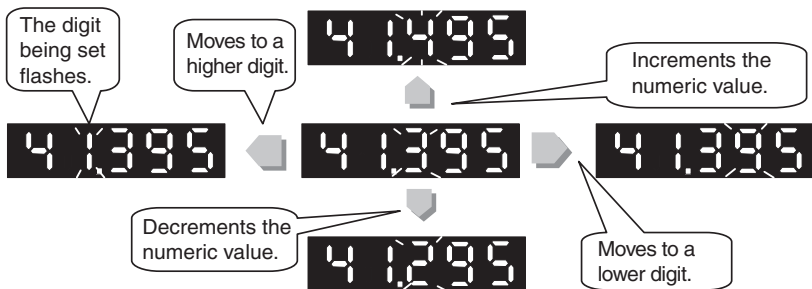

■ **Confirming the Numeric Value**

The flashing numeric value must be confirmed to be stored. The numeric value is confirmed using the following method.

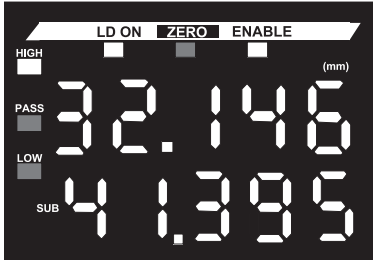

When you finish adjusting the numeric value, press the ENT Key to confirm the value.

↓ Press the ENT Key.

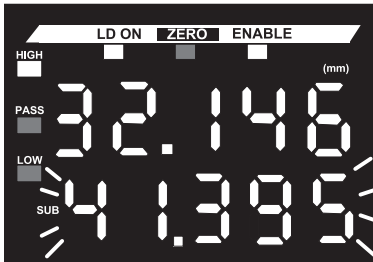

All digits will flash twice.

↓ The display will light continuously after flashing twice.

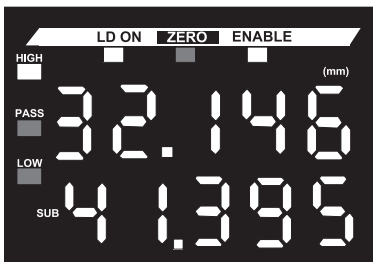

The numeric value will be stored in EEPROM after the display flashes twice and then lights continuously.



Changes made to threshold values will be canceled if the mode is changed using the mode switch or if the setting of the threshold switch is changed while the display is flashing.

4-5 FUN (Function) Mode

4-5-1 Normal Operation

The Function Mode is used to set various functions. Basic procedures for setting items are described in the next section.

In RUN Mode, outputs are made in Function Mode in the KEEP status regardless of the KEEP/CLAMP setting for non-measurement.

4-5-2 Changing the Function

The basics of changing the function are as follows:

The **RIGHT Key**  **changes to the next item (forward).**

The **LEFT Key**  **changes to the previous item (backward).**

Example: Changing the Function Forward

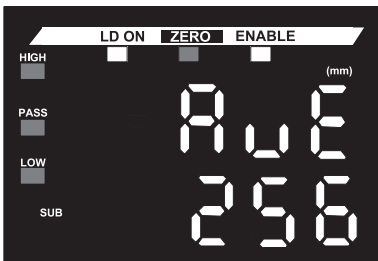

Set the mode switch to FUN.



RUN T FUN

Change the function by pressing either the RIGHT (forward) or LEFT (backward) Key.



Pressing the RIGHT Key changes the function forward.

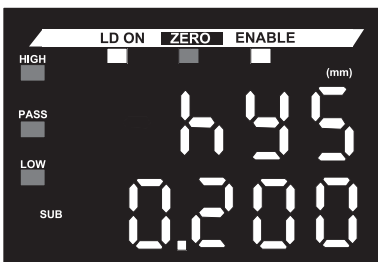

The current set value will be displayed on the sub-display.

4-5-3 Changing Non-numeric Set Values

The following procedure is used to change set values other than numeric values for the functions that require changing.

Example: Changing the Hold Mode

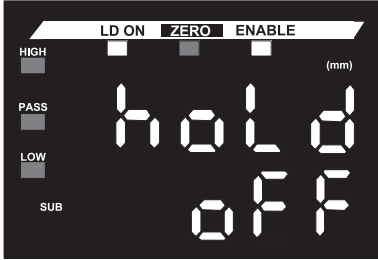

Change the function to the one that requires setting using the procedure given in 4-5-2 *Changing the Function*.

Press either the UP or DOWN Key to start the setting change.

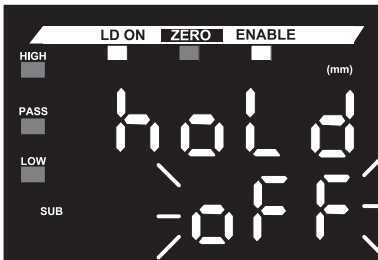
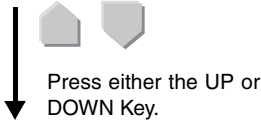

The current set value will flash on the sub-display.

Change the set value using the procedure shown in the following figure.

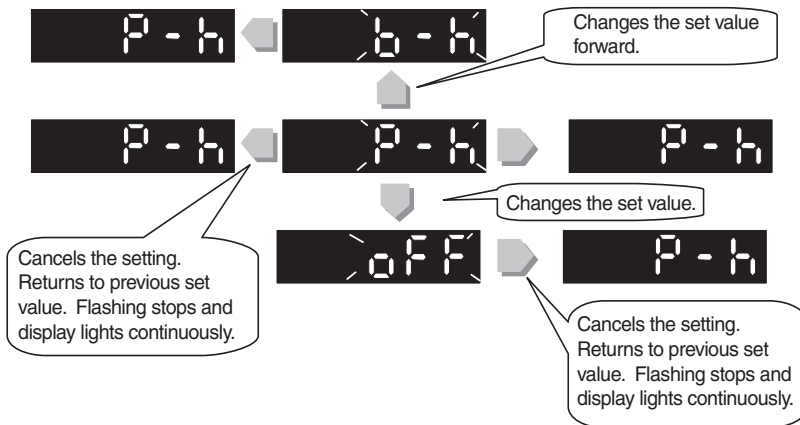

■ **Confirming the Set Value**

The flashing set value must be confirmed to be stored. The numeric value is confirmed using the following method.

Example:

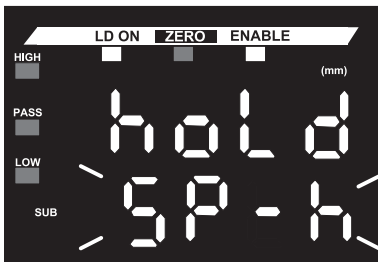

When you finish selecting the set value, press the ENT Key to confirm the setting.

↓ Press the ENT Key.

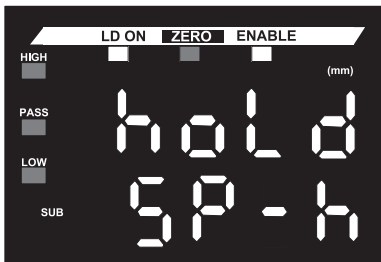

The set value will be stored in EEPROM after the display flashes twice and then lights continuously.

4-5-4 Changing Numeric Set Values

The following procedure is used to change the numeric set value for the functions that require changing.

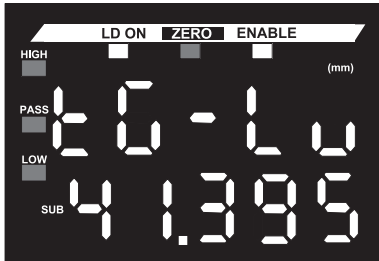

Change the function to the one that requires setting using the procedure given in 4-5-2 *Changing the Function*. Press either the UP or DOWN Key to start changing the setting.

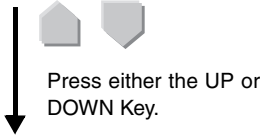

The leftmost digit of the set numeric value will flash on the sub-display.

Change the set value using the procedure shown in the following figure.

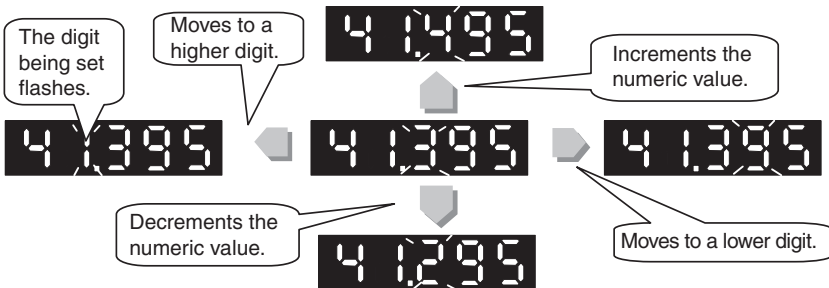

The setting operation will be canceled and the previous set value will be displayed if the LEFT Key is pressed at the leftmost digit or the RIGHT Key is pressed at the rightmost digit when setting a numeric value (flashing).

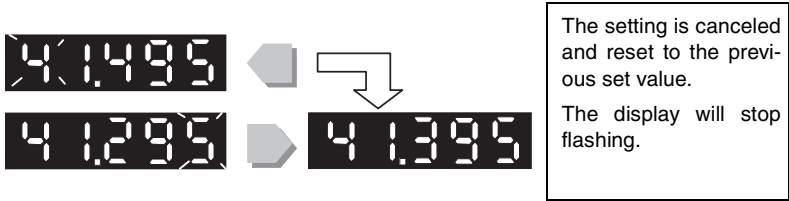

■ **Confirming the Numeric Value**

The flashing set value must be confirmed to be stored. The numeric value is confirmed using the following method.

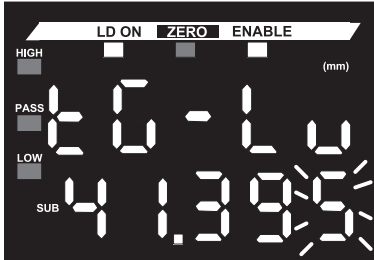

When you finish adjusting the numeric value, press the ENT Key to confirm the value.

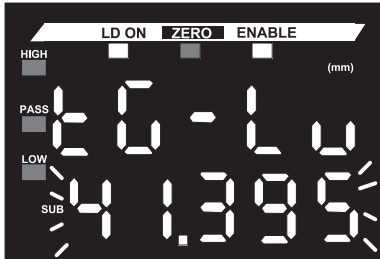
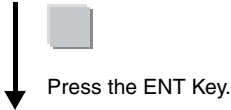

All digits will flash twice.

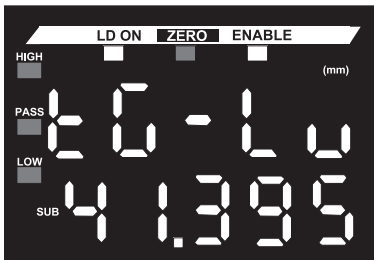
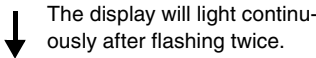

The numeric value will be stored in EEPROM after the display flashes twice and then lights continuously.

■ **Errors when Confirming a Numeric Value**

A setting error will occur under the following conditions.

1. When the set value is too large.
2. When the set value is too small.

If an error occurs, the relevant error will be displayed on the sub-display three times at one-second intervals as shown in the following figure, and then the previous set value will be displayed.

1. ErroV (Error: Over)

2. ErrUd (Error: Under)

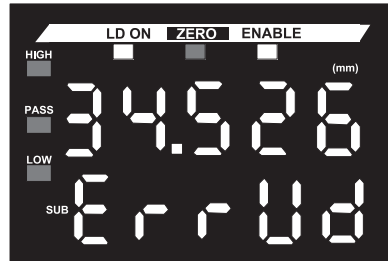
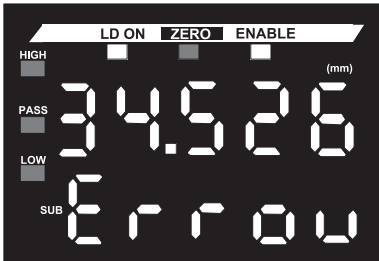

The error is displayed when the ENT Key is pressed.

4-5-5 Key Lock

This function disables the control keys.

■ Setting the Key Lock

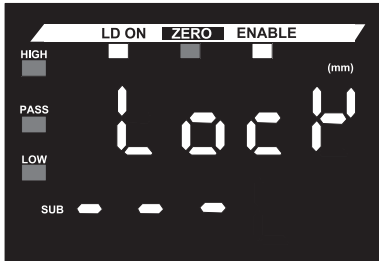

Press the UP, DOWN, RIGHT, and LEFT Keys at the same time for 3 seconds.

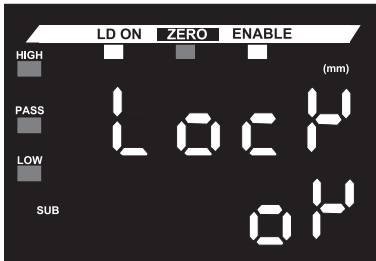

■ Releasing the Key Lock

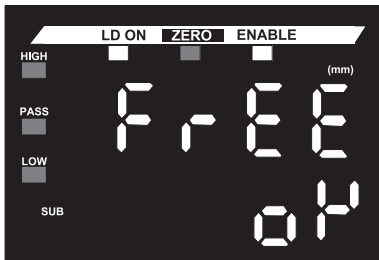

Set the mode switch to FUN.



RUN T FUN

Press the UP, DOWN, RIGHT, and LEFT Keys at the same time for 3 seconds or longer.

“Lock” will be displayed on the main display and “——” will be displayed on the sub-display for 3 seconds.

After 3 seconds, “OK” will be displayed on the sub-display to complete the key lock process.

Press the UP, DOWN, RIGHT, and LEFT Keys at the same time for 3 seconds or longer.

“FrEE” will be displayed on the main display and “——” will be displayed on the sub-display for 3 seconds.

After 3 seconds, “OK” will be displayed on the sub-display to complete the key lock releasing process.

The following operations are enabled while the keys are locked:

- Changing the mode switch
- Changing the threshold switch
- Releasing the key lock

4-5-6 FUN Mode Status Transitions

The status transitions in the FUN mode are shown in the following chart.

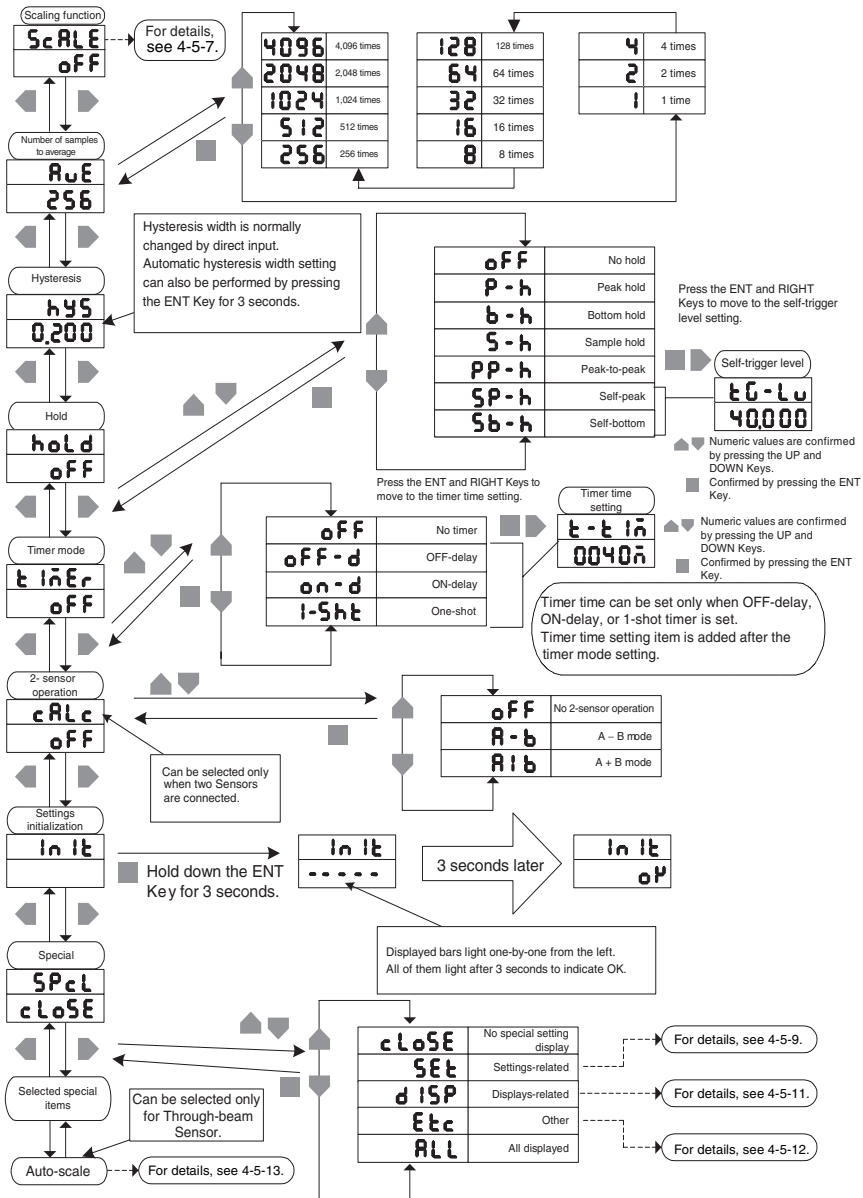

4-5-7 Setting Scaling

The procedure used to set scaling is shown below.

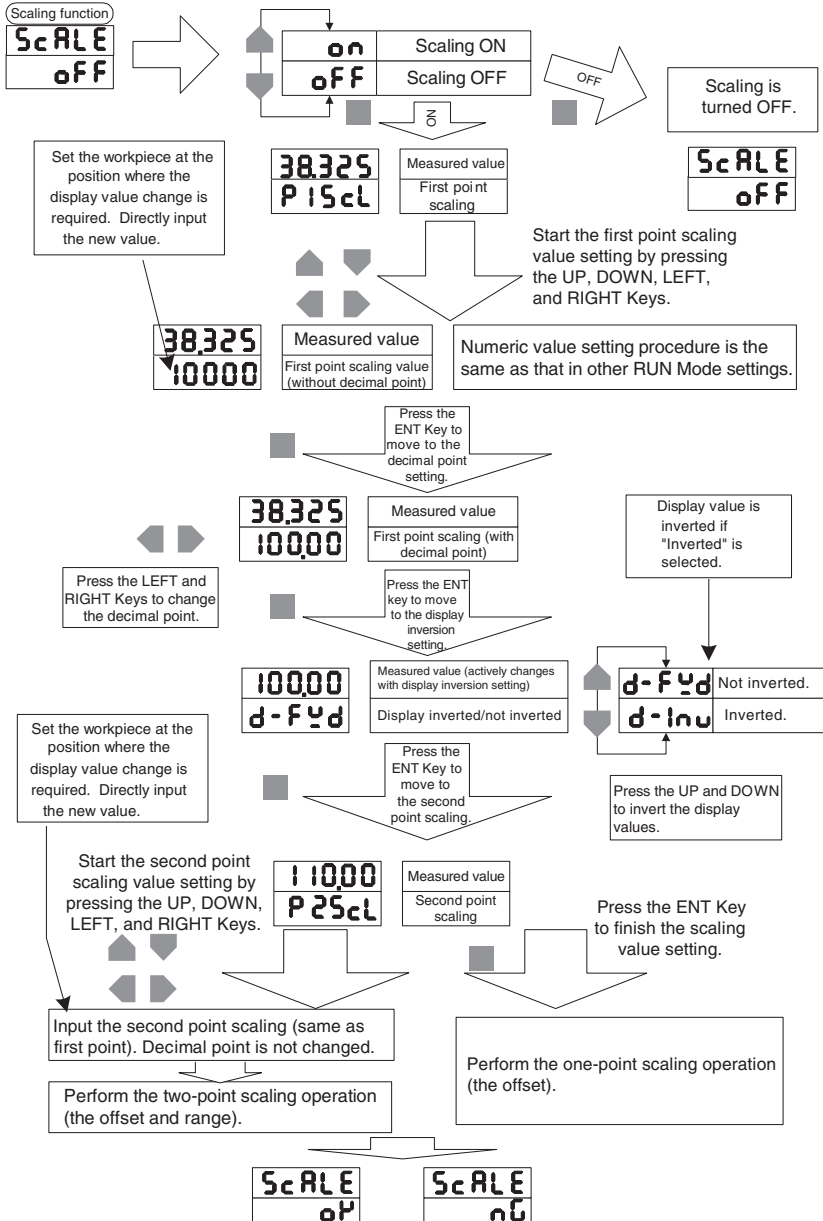

4-5-8 Initializing Settings

This function resets all settings to their default values.

■ Procedure

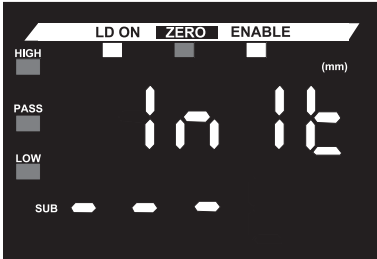

↓
Press the ENT Key for 3 seconds.

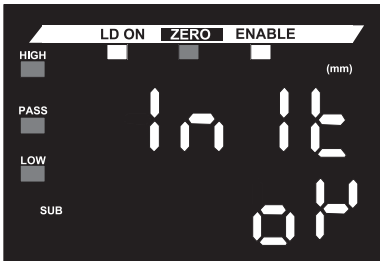

Set the mode switch to FUN and select "InIt" on the main display.

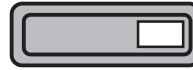

RUN T FUN

Press the ENT Key for 3 seconds or longer.

"InIt" will be displayed on the main display and "—" will be displayed on the sub-display for 3 seconds.

After 3 seconds, "OK" will be displayed on the sub-display to complete the initialization process.

4-5-9 Special FUN Mode Settings Related to Settings

The following setting-related items can be set when **SET** or **ALL** is selected in the special FUN mode settings.

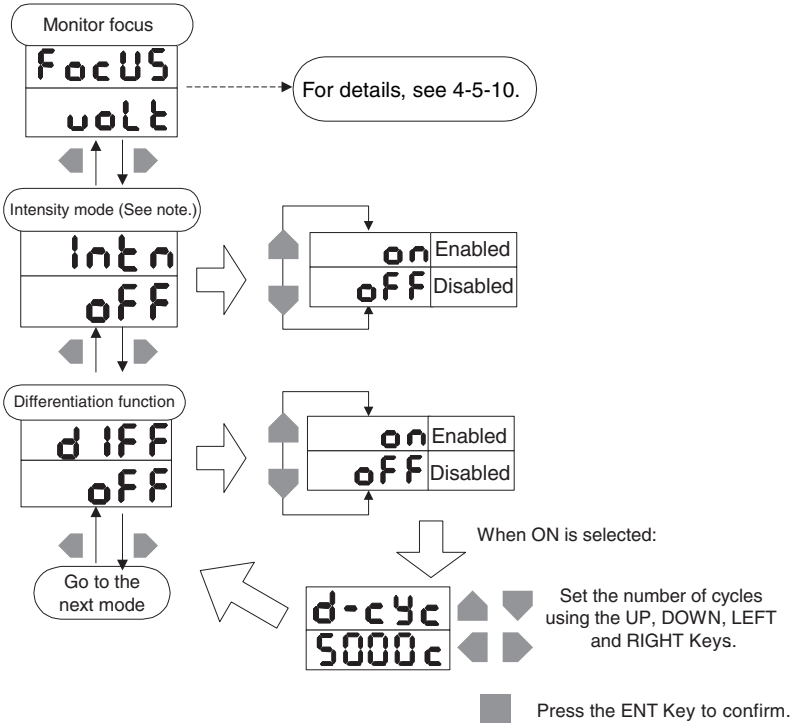

Note: The Intensity Mode can be set only for a Reflective Sensor.

4-5-10 Setting the Monitor Focus

The monitor focus setting procedure is shown in the following figure:

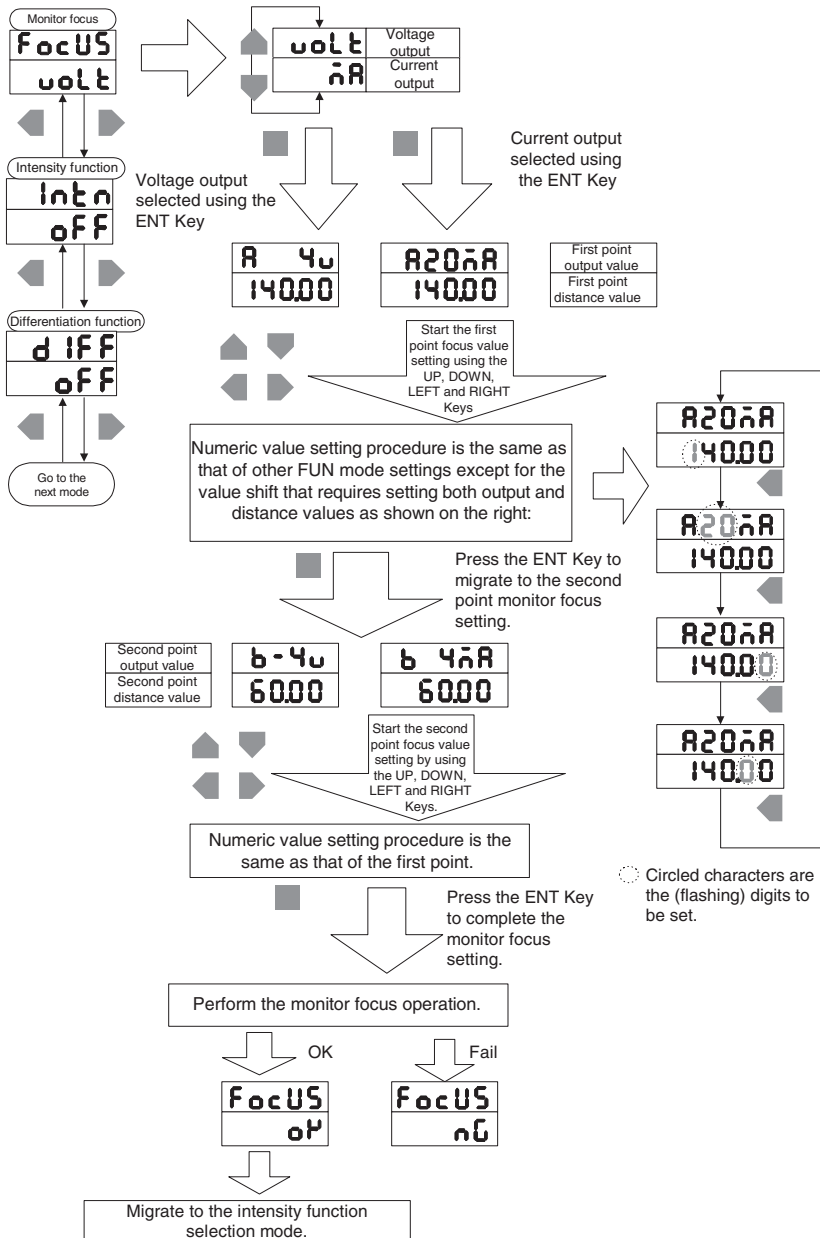

4-5-11 Special FUN Mode Settings Related to Displays

The following display-related items can be set when **dISP** or **ALL** is selected in the special FUN mode settings.

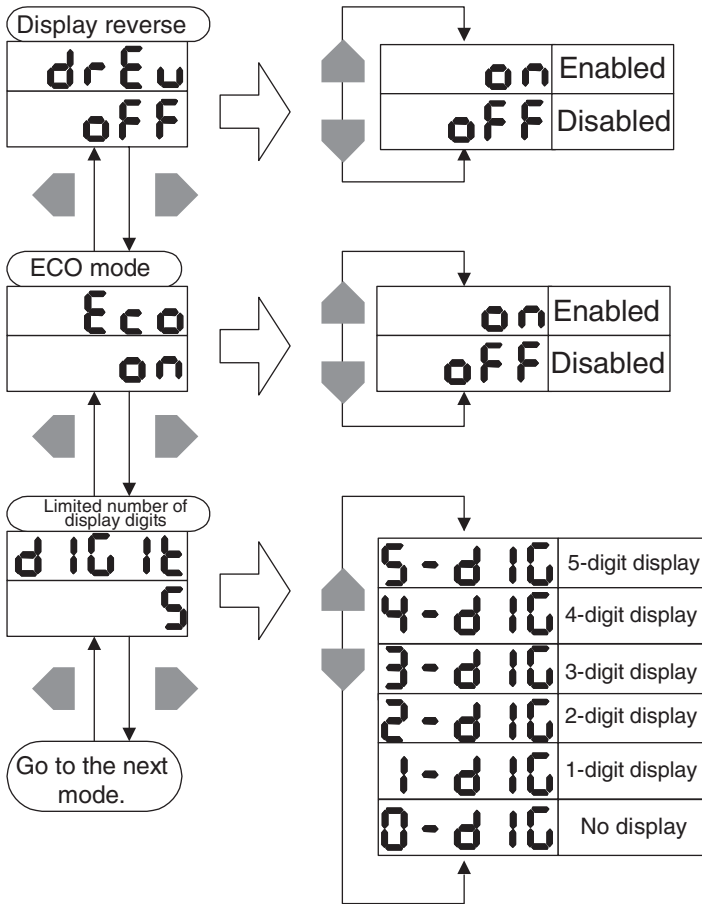

4-5-12 Other Special FUN Mode Settings

The following “other” items can be set when **EtC** or **ALL** is selected in the special FUN mode settings

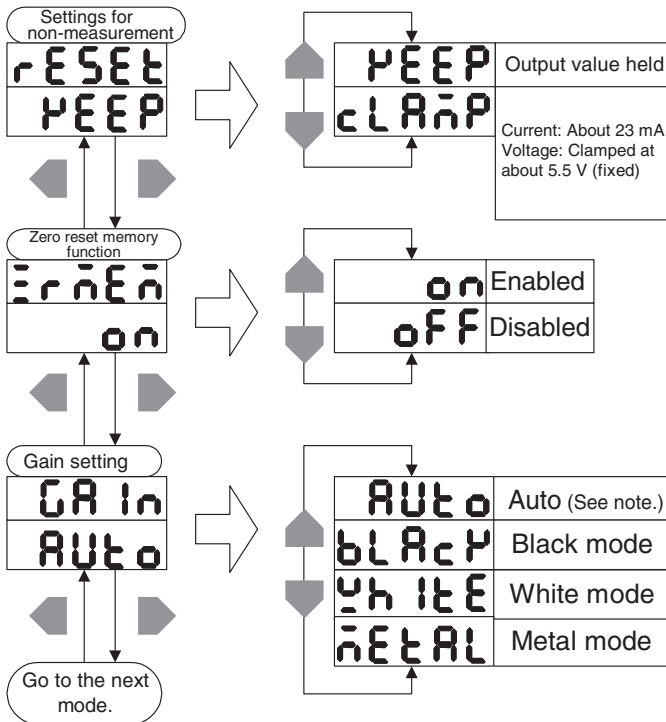

Note: This function can be set only for a Reflective Sensor.

4-5-13 Auto-scale Settings

The auto-scale setting procedure is shown in the following figure. This function can be set only for a Through-beam Sensor.

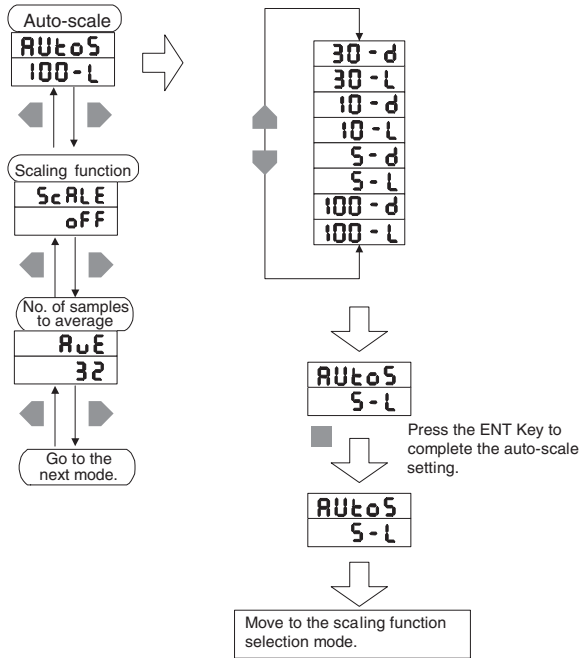

Memo

SECTION 5 Troubleshooting

This section describes the displays and countermeasures used for errors.

5-1 Error Displays	142
5-1-1 Error Displays during Normal Measurement	142
5-1-2 Error Displays during Numeric Value Setting	143
5-1-3 Error Displays during Two-sensor Operation	143
5-2 Setting Problems.....	144
5-2-1 Unable to Set Scaling.....	144
5-2-2 Unable to Set Monitor Focus.....	144
5-2-3 Unable to Set Threshold Values.....	144
5-2-4 Unable to Set Hysteresis.....	144
5-2-5 Distance Measurement Errors.....	145
5-2-6 Laser Deterioration.....	145

5-1 Error Displays

5-1-1 Error Displays during Normal Measurement

Display	Cause and countermeasure	Recovery
E - Sht (Flashing)	One or all of the judgement outputs are short-circuited. → Clear the load short-circuit.	Automatic recovery
E - EEP (Flashing)	EEPROM destruction or data error → Press the ENT Key for 3 seconds or longer. → Replace the Amplifier Unit if the above countermeasure does not solve the problem.	Automatic recovery or replacement
E - hEd (Flashing)	The Sensor Head is disconnected or there is a Sensor Head error. → Connect the Sensor Head. → Replace the Sensor Head if the above countermeasure does not solve the problem.	Automatic recovery or replacement
E - drT (Flashing) (See note 3.)	Incident level insufficient or distance measurement error (Refer to 5-2-5.) → Optimize the gain setting or select the AUTO mode when changing the gain setting. → Change to an appropriate workpiece if the above countermeasure does not solve the problem.	Automatic recovery
E - brt (Flashing) (See note 3.)	Incident level saturation or distance measurement error (Refer to 5-2-5.) → Optimize the gain setting or select the AUTO mode when changing the gain setting. → Change to an appropriate workpiece if the above countermeasure does not solve the problem.	Automatic recovery
E - LuL (Flashing) (See note 3.)	Distance error → Set the workpiece within the measurable range.	Automatic recovery

- Note**
1. Although teaching is impossible, threshold values can be input directly even for an insufficient incident level, an incident level saturation, or a distance measurement error.
 2. The display priority is in descending order from the top of the above table when more than one error occurs at the same time.
 3. The error is displayed only for a Reflective Sensor Head.

5-1-2 Error Displays during Numeric Value Setting

Display	Cause and countermeasure	Recovery
E r r L h (Flashing)	Attempted to set a numeric value larger than the HIGH threshold value to the LOW threshold value. → Reset the threshold values, referring to 5-2-3.	Automatic recovery
E r r h L (Flashing)	Attempted to set a numeric value smaller than the LOW threshold value to the HIGH threshold value. → Reset the threshold values, referring to 5-2-3.	Automatic recovery
E r r o u (Flashing)	The set numeric value is too large. (Refer to 5-2-1 to 5-2-4.) → Input an appropriate numeric value.	Automatic recovery
E r r U d (Flashing)	The set numeric value is too small. (Refer to 5-2-1 to 5-2-4.) → Input an appropriate numeric value.	Automatic recovery

5-1-3 Error Displays during Two-sensor Operation

Display	Cause and countermeasure	Recovery
E - d R t (Flashing)	Two-sensor operation communication data error → Select the T or RUN Mode for the 1CH Amplifier Unit. → Check whether a incident level error has occurred for the 1CH Amplifier Unit. → Check whether the connection between the Amplifier Units is normal. → Replace the Amplifier Unit or the Calculating Unit if the above countermeasures do not solve the problem.	Automatic recovery or replacement
E - c h L (Flashing)	One-sensor operation was attempted while selecting the A – B or A + B operation. → Perform one-sensor operation by reconnecting the Units and turning OFF two-sensor operation. → Initialize the settings if the above countermeasure is not possible.	Automatic reset
E - I n t (Flashing) (See note.)	Attempted two-sensor operation for two Amplifier Units with Intensity Mode ON on one Unit and OFF on the other. → Use the same Intensity Mode setting for both Amplifier Units.	Automatic reset

Note: The error is displayed only for a Reflective Sensor Head.

5-2 Setting Problems

5-2-1 Unable to Set Scaling

Scaling cannot be set in the following cases.

- When scaling is performed outside the measurable range when a Reflective Sensor Head is used.
- When the distance (or width) of two-point scaling is less than 10% of full scale (FS).
- When the numeric value for scaling input is extremely small or large.

5-2-2 Unable to Set Monitor Focus

The monitor focus cannot be set when specified distances (or widths) between two points is less than 10% of full scale (FS).

Set the monitor focus after performing scaling.

It is recommended that the linear output value for display value be determined using the scaling after setting the display value for actual distances (or widths).

5-2-3 Unable to Set Threshold Values

Always set threshold values to satisfy the following formula:

$$\text{HIGH threshold value} > \text{LOW threshold value}$$

In addition, the threshold values cannot be set if the PASS judgement cannot be made because the hysteresis (Hys) is too large and the following equation is true:

$$(\text{HIGH threshold value} - \text{LOW threshold value}) < \text{Hys}$$

5-2-4 Unable to Set Hysteresis

The hysteresis cannot be set if the PASS judgement cannot be made because the hysteresis (Hys) is too large and the following equation is true:

$$(\text{HIGH threshold value} - \text{LOW threshold value}) < \text{Hys}$$

Decrease the setting of the hysteresis to eliminate the above condition.

5-2-5 Distance Measurement Errors

These errors are displayed only for a Reflective Sensor Head.

A distance measurement error indicates the inability to carry out measurement due to an incident level error. This occurs in the following cases:

- | | |
|------------------------------|---|
| Insufficient incident level: | The incident level may be insufficient when the sensing object reflectivity is extremely small, such as for black rubber. |
| Incident level saturation: | The incident level may be saturated when the sensing object reflectivity is extremely large, such as for a mirror. |
| Distance error: | An error may occur when the sensing object is outside the sensing range and the reflected light does not arrive at the correct receiver position. |

5-2-6 Laser Deterioration

LddYn will be displayed on the main display for 5 seconds when the power is turned ON if the Sensor Head laser has deteriorated. Replace the Sensor Head.

Memo

SECTION 6 Specifications and Dimensions

This section provides ratings and performances.

6-1 Ratings/Specifications.....	148
6-1-1 Reflective Sensor Heads.....	148
6-1-2 Through-beam Sensor Heads.....	152
6-1-3 Amplifier Units.....	153
6-1-4 Calculating Unit.....	155
6-2 Dimensions.....	156
6-2-1 Reflective Sensor Heads.....	156
6-2-2 Through-beam Sensor Heads.....	158
6-2-3 Amplifier Units.....	164
6-2-4 Calculating Unit.....	165

6-1 Ratings/Specifications

6-1-1 Reflective Sensor Heads

■ Ratings

Item	ZX-LD40	ZX-LD100	ZX-LD300
Optical system	Diffuse reflective		
Applicable Amplifier Units	ZX-LDA11/41		
Measurement point	40 mm	100 mm	300 mm
Measurement range	±10 mm	±40 mm	±200 mm
Light source	Visible-light semiconductor laser with a wavelength of 650 nm and an output of 1 mW max.; class 2		
Beam shape	Spot		
Beam size (See note 1.)	50- μ m dia.	100- μ m dia.	300- μ m dia.
Resolution (See note 2.)	2 μ m	16 μ m	300 μ m
Linearity (See note 3.)	±0.2% FS (entire range)	±0.2% FS (80 to 120 mm)	±2% FS (200 to 400 mm)
Temperature characteristic (See note 4.)	±0.03% FS/°C		±0.1% FS/°C
Ambient temperature	Operating: 0 to 50°C, Storage: -15 to 60°C (with no icing or condensation)		
Ambient humidity	Operating and storage: 35% to 85% (with no condensation)		
Ambient illumination	Incandescent lamp: 3,000 lx max. (on light receiving side)		
Insulation resistance	20 M Ω min. at 500 VDC		
Dielectric strength	1,000 VAC, 50/60 Hz for 1 min.		
Vibration resistance (destruction)	10 to 150 Hz, 0.7-mm double amplitude 80 min each in X, Y, and Z directions		
Shock resistance (destruction)	300 m/s ² 3 times each in six directions (up/down, left/right, forward/backward)		
Degree of protection	IEC 60529, IP50		
Connection method	Connector relay (standard cable length: 500 mm)		
Materials	Case: PBT (polybutylene terephthalate), Cover: Aluminum, Lens: Glass		
Weight (packed state)	Approx. 150 g		
Accessories	Instruction sheet, Laser warning label (English)		

Item	ZX-LD40L	ZX-LD100L	ZX-LD300L
Optical system	Diffuse reflective		
Applicable Amplifier Units	ZX-LDA11/41		
Measurement point	40 mm	100 mm	300 mm
Measurement range	±10 mm	±40 mm	±200 mm
Light source	Visible-light semiconductor laser with a wavelength of 650 nm and an output of 1 mW max.; class 2		
Beam shape	Line		
Beam size (See note 1.)	75 μm x 2 mm	150 μm x 2 mm	450 μm x 2 mm
Resolution (See note 2.)	2 μm	16 μm	300 μm
Linearity (See note 3.)	±0.2% FS (32 to 48 mm)	±0.2% FS (80 to 120 mm)	±2% FS (200 to 400 mm)
Temperature characteristic (See note 4.)	±0.03% FS/°C		±0.1% FS/°C
Ambient temperature	Operating: 0 to 50°C, Storage: -15 to 60°C (with no icing or condensation)		
Ambient humidity	Operating and storage: 35% to 85% (with no condensation)		
Ambient illumination	Incandescent lamp: 3,000 lx max. (on light receiving side)		
Insulation resistance	20 MΩ min. at 500 VDC		
Dielectric strength	1,000 VAC, 50/60 Hz for 1 min.		
Vibration resistance (destruction)	10 to 150 Hz, 0.7-mm double amplitude 80 min each in X, Y, and Z directions		
Shock resistance (destruction)	300 m/s ² 3 times each in six directions (up/down, left/right, forward/backward)		
Degree of protection	IEC 60529, IP50		
Connection method	Connector relay (standard cable length: 500 mm)		
Materials	Case: PBT (polybutylene terephthalate), Cover: Aluminum, Lens: Glass		
Weight (packed state)	Approx. 150 g		
Accessories	Instruction sheet, Laser warning label (English)		

Item	ZX-LD30V	ZX-LD30VL
Optical system	Regular reflective	
Applicable Amplifier Units	ZX-LDA11/41	
Measurement point	30 mm	
Measurement range	±2 mm	
Light source	Visible-light semiconductor laser with a wavelength of 650 nm and an output of 1 mW max.; class 2	
Beam shape	Spot	Line
Beam size (See note 1.)	75- μ m dia.	100 μ m x 1.8 mm
Resolution (See note 2.)	0.25 μ m	
Linearity (See note 3.)	±0.2% FS (entire range)	
Temperature characteristic (See note 4.)	±0.03% FS/°C	
Ambient temperature	Operating: 0 to 50°C, Storage: -15 to 60°C (with no icing or condensation)	
Ambient humidity	Operating and storage: 35% to 85% (with no condensation)	
Ambient illumination	Incandescent lamp: 3,000 lx max. (on light receiving side)	
Insulation resistance	20 M Ω min. at 500 VDC	
Dielectric strength	1,000 VAC, 50/60 Hz for 1 min.	
Vibration resistance (destruction)	10 to 150 Hz, 0.7-mm double amplitude 80 min each in X, Y, and Z directions	
Shock resistance (destruction)	300 m/s ² 3 times each in six directions (up/down, left/right, forward/backward)	
Degree of protection	IEC 60529, IP40	
Connection method	Connector relay (standard cable length: 500 mm)	
Materials	Case and cover: Aluminum, Lens: Glass	
Weight (packed state)	Approx. 250 g	
Accessories	Instruction sheet, Laser warning label (English)	

FS: Full scale of measurement range

- Note 1.** Beam size: Beam size refers to the distance across the center of measurement. It indicates the typical value for the distance across the center of detection. The beam size is defined by $1/e^2$ (13.5%) of the strength of the beam at the beam center. It may be affected by light leakage around the main beam and by conditions in the area surrounding the sensing object.
- 2.** Resolution: The resolution is the deviation ($\pm 3\sigma$) in the linear output when connected to the Amplifier Unit (setting the average count to 4,096 per period, with the standard reference object set at the distance across the center).

3. Linearity: The linearity is given as the error in an ideal straight line for the displacement output when measuring the standard reference object. (The linearity value varies with the object being measured.) The standard reference object is white ceramic.
4. Temperature characteristic: The temperature characteristic is measured at the measurement center with the Sensor and sensing object (standard reference object) secured with an aluminum jig.
5. Highly reflective objects can result in incorrect detection outside the full scale of measurement range.

6-1-2 Through-beam Sensor Heads

Item	ZX-LT001	ZX-LT005	ZX-LT010	
Applicable Amplifier Units	ZX-LDA11/41			
Light source	Visible-light semiconductor laser (650-nm wavelength)			
Output	0.2 mW max.	0.35 mW max.		
Measurement distance	0 to 500 mm	500 to 2,000 mm	0 to 500 mm	
Measurement width	1-mm dia.	1- to 2.5-mm dia.	5 mm	10 mm
Minimum sensing object	8- μ m dia. (opaque)	8- to 50- μ m dia. (opaque)	0.05-mm dia. (opaque)	0.1-mm dia. (opaque)
Resolution (See note 1.)	4 μ m (See note 2.)	---	4 μ m (See note 3.)	
Temperature characteristic	0.2% F.S./ $^{\circ}$ C max.			
Ambient illumination	Incandescent lamp: 10,000 lx max. (on light receiving side)			
Ambient temperature	Operating: 0 to 50 $^{\circ}$ C, Storage: -25 to 70 $^{\circ}$ C (with no icing or condensation)			
Ambient humidity	Operating and storage: 35% to 85% (with no condensation)			
Degree of protection	IEC 60529, IP40			
Cable length	Extendable up to 10 m with special extension cable.			
Weight (packed state)	Approx. 220 g			
Materials	Case: Polyetherimide, Case cover: Polycarbonate, Unit cover: Glass			
Tightening torque	0.3 N·m max.			
Accessories	Optical axis adjustment seal, sensor head-amplifier connection cable, instruction sheet			

- Note**
1. This value is obtained by converting the deviation ($\pm 3\sigma$) in the linear output that results when the Sensor Head is connected to the Amplifier Unit, into the measurement width.
 2. For a measurement distance of 0 to 500 mm and an average count of 64. The value is 5 μ m for an average count of 32. This is the value that results when a minimum sensing object blocks the light near the center of the 1-mm measurement width.
 3. For an average count of 64. The value is 5 μ m for an average count of 32.

6-1-3 Amplifier Units

Item	ZX-LDA11	ZX-LDA41
Measurement period	150 μS	
Possible average count settings (See note 1.)	1, 2, 4, 8, 16, 32, 64, 128, 256, 512, 1,024, 2,048, or 4,096	
Temperature characteristic	When connected to a Reflective Sensor Head: 0.01% FS/°C When connected to a Through-beam Sensor Head: 0.1% FS/°C	
Linear output (See note 3.)	Current output: 4 to 20 mA/FS, Max. load resistance: 300 Ω Voltage output: ±4 V (± 5 V, 1 to 5 V, See note 4.), Output impedance: 100 Ω	
Judgement outputs (3 outputs: HIGH/PASS/LOW)	NPN open-collector outputs, 30 VDC, 50 mA max. Residual voltage: 1.2 V max.	PNP open-collector outputs, 30 VDC, 50 mA max. Residual voltage: 2 V max.
Laser OFF input	ON: Short-circuited with 0-V terminal or 1.5 V or less	ON: Supply voltage short-circuited or within supply voltage 1.5 V
Zero reset input	OFF: Open (leakage current: 0.1 mA max.)	OFF: Open (leakage current: 0.1 mA max.)
Timing input		
Functions	<ul style="list-style-type: none"> ◆ Measured value display ◆ Set value/light level/resolution display ◆ Scaling ◆ Display reverse ◆ Display OFF mode ◆ ECO mode ◆ Number of display digit changes ◆ Sample hold ◆ Peak hold ◆ Bottom hold ◆ Peak-to-peak hold ◆ Self-peak hold ◆ Self-bottom hold ◆ Intensity Mode (See note 5.) ◆ Auto-scale (See note 6.) ◆ Zero reset ◆ Initial reset ◆ ON-delay timer ◆ OFF-delay timer ◆ One-shot timer ◆ Differentiation/Sensitivity adjustment ◆ Keep/clamp switch ◆ Direct threshold value setting ◆ Position teaching ◆ 2-point teaching ◆ Automatic teaching ◆ Hysteresis width setting ◆ Timing inputs ◆ Reset input ◆ Monitor focus ◆ Setting for non-measurement (See note 2.) ◆ (A-B) calculations (See note 2.) ◆ (A+B) calculations (See note 2.) ◆ Mutual interference (See note 2.) ◆ Laser deterioration detection ◆ Key lock ◆ Zero reset memory 	

Item	ZX-LDA11	ZX-LDA41
Indications	Operation indicators: High (orange), pass (green), low (yellow), 7-segment main display (red), 7-segment sub-display (yellow), laser ON (green), zero reset (green), enable (green)	
Power supply voltage	12 to 24 VDC \pm 10%, Ripple (p-p): 10% max.	
Power consumption	Maximum 3.4 W (Sensor connected) (Power supply voltage: 24 V, Current consumption: Maximum 140 mA)	
Ambient temperature	Operating: 0 to 50°C, Storage: -15 to 60°C (with no icing or condensation)	
Ambient humidity	Operating and storage: 35% to 85% (with no condensation)	
Insulation resistance	20 M Ω min. at 500 VDC	
Dielectric strength	1,000 VAC, 50/60 Hz for 1 min	
Vibration resistance (destructive)	10 to 150 Hz, 0.7-mm double amplitude 80 min each in X, Y, and Z directions	
Shock resistance (destructive)	300 m/s ² 3 times each in six directions (up/down, left/right, forward/backward)	
Connection method	Prewired (standard cable length: 2 m)	
Weight (packed state)	Approx. 350 g	
Materials	Case: PBT (polybutylene terephthalate), Cover: Polycarbonate	
Accessories	Instruction sheet	

- Note**
1. The response speed of the linear output is calculated as the measurement period \times (average count setting + 1) (with fixed sensitivity).
The response speed of the judgement outputs is calculated as the measurement period \times (average count setting + 1) (with fixed sensitivity).
 2. A Calculating Unit is required.
 3. The output can be switched between current output and voltage output using a switch on the bottom of the Amplifier Unit.
 4. Setting is possible via the monitor focus function.
 5. This function can be set only with a Reflective Sensor Head.
 6. This function can be set only with a Through-beam Sensor Head.

6-1-4 Calculating Unit

Item	ZX-CAL
Applicable Amplifier Units	ZX-LDA11/41
Current consumption	Maximum 12 mA (supplied from the Smart Sensor Amplifier Unit)
Ambient temperature	Operating: 0 to 50°C, Storage: -15 to 60°C (with no icing or condensation)
Ambient humidity	Operating and storage: 35% to 85% (with no condensation)
Connection method	Connector
Dielectric strength	1,000 VAC, 50/60 Hz for 1 min
Insulation resistance	100 M Ω (at 500 VDC)
Vibration resistance (destructive)	10 to 150 Hz, 0.7-mm double amplitude 80 min each in X, Y, and Z directions
Shock resistance (destructive)	300 m/s ² 3 times each in six directions (up/down, left/right, for- ward/backward)
Materials	Display: Acrylic, Case: ABS resin
Weight (packed state)	Approx. 50 g

6-2 Dimensions

6-2-1 Reflective Sensor Heads

- ZX-LD□□/ZX-LD□□L

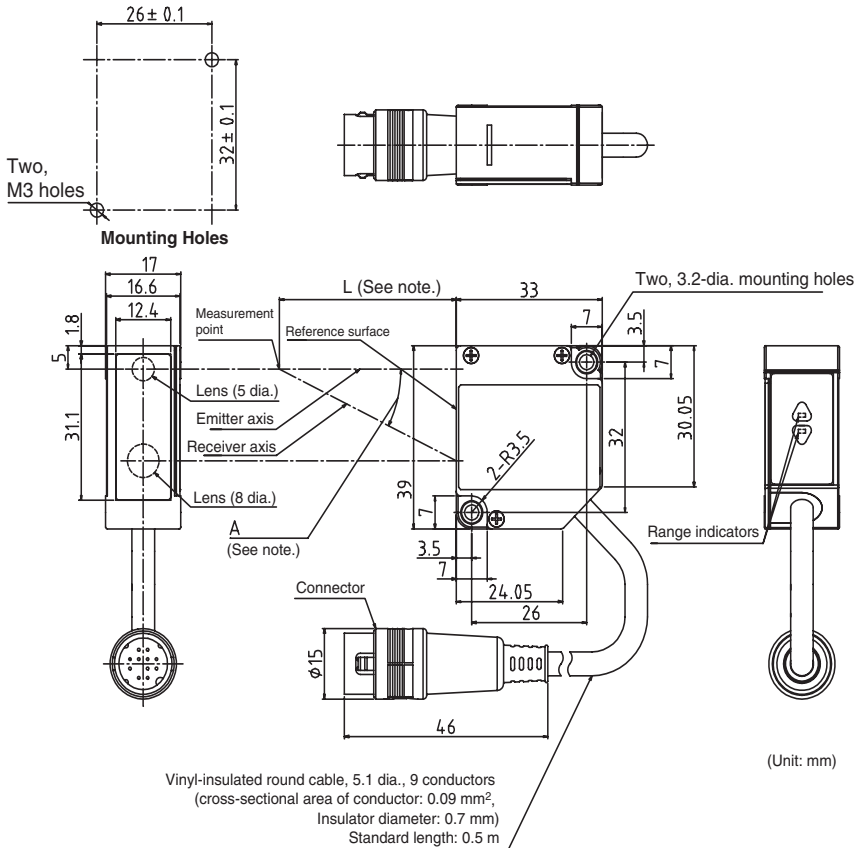

Note:

Model	L (mm)	A (°)
ZX-LD40	40	23
ZX-LD100	100	11
ZX-LD300	300	3.8
ZX-LD40L	40	23
ZX-LD100L	100	11
ZX-LD300L	300	3.8

■ ZX-LD30V /ZX-LD30VL

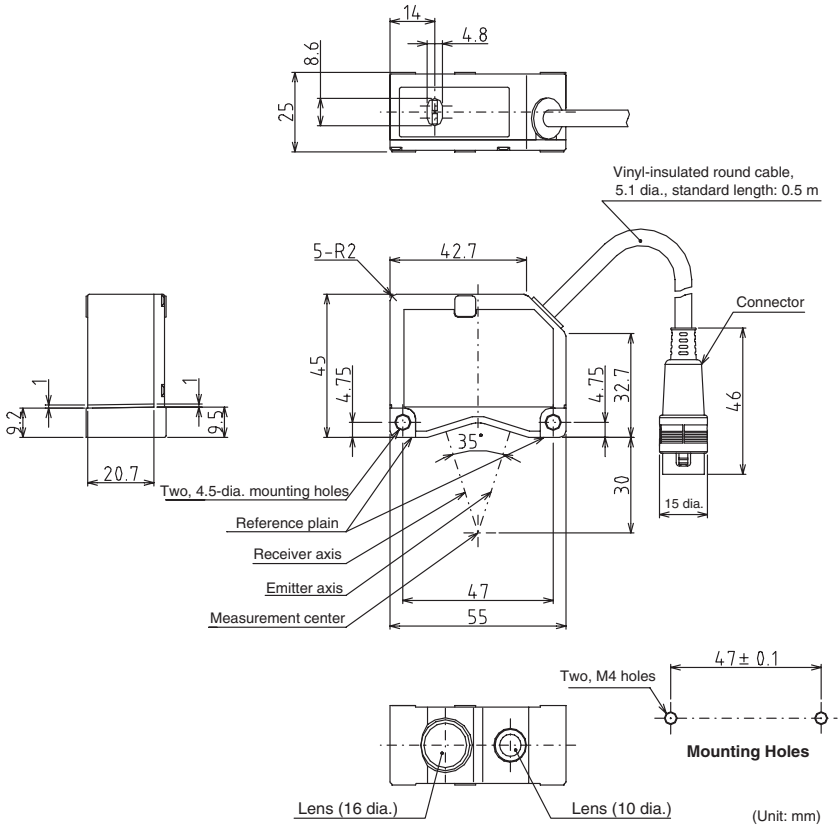

6-2-2 Through-beam Sensor Heads

■ ZX-LT001

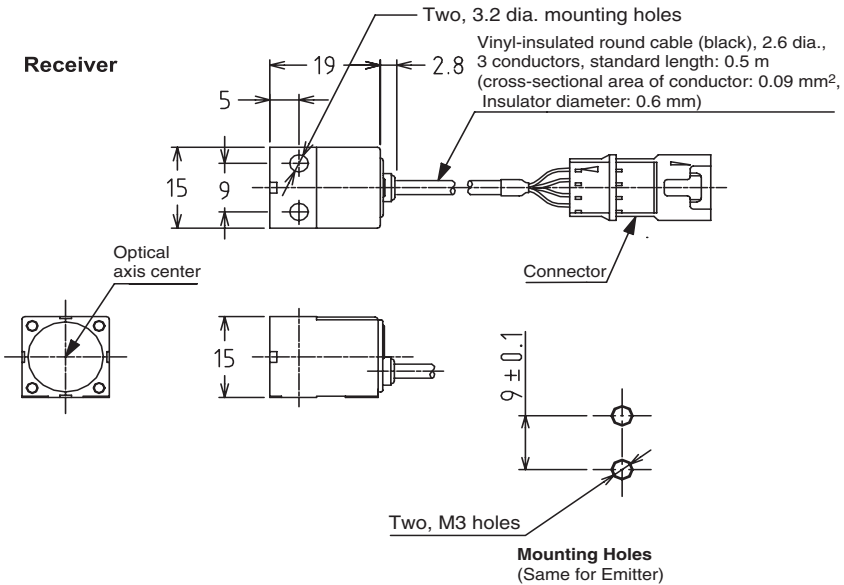
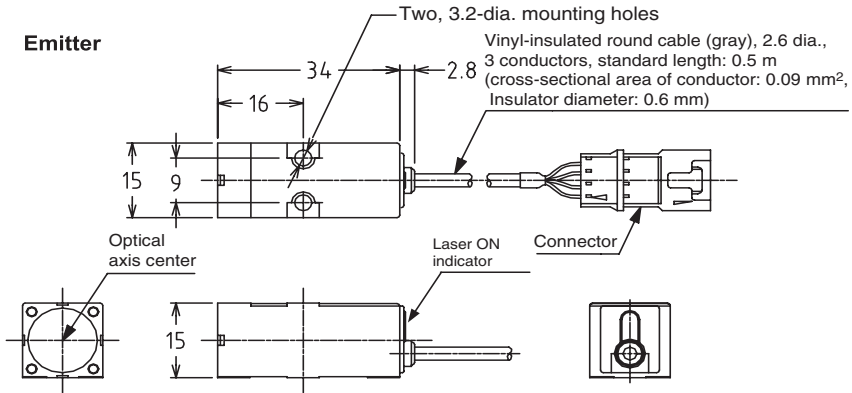

(Unit: mm)

Dimensions with ZX-XF12 Side-view Attachment Mounted

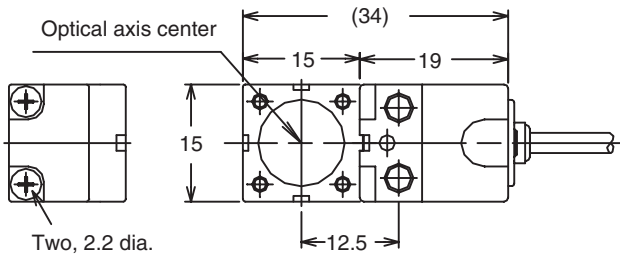
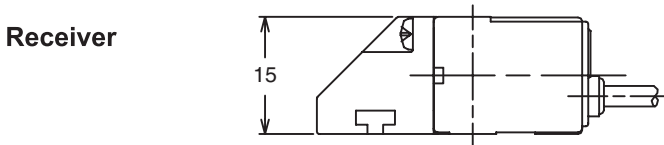
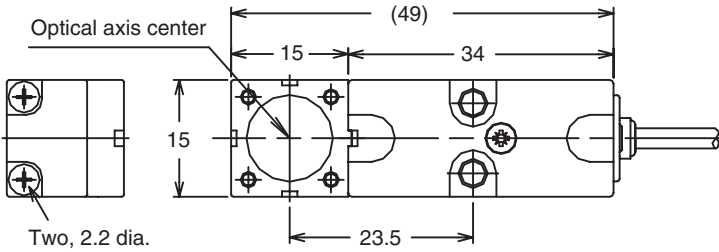
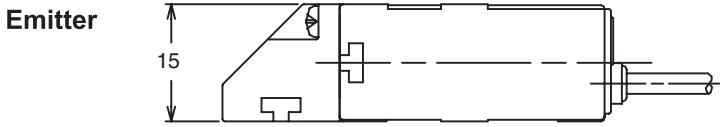

(Unit: mm)

■ ZX-LT005

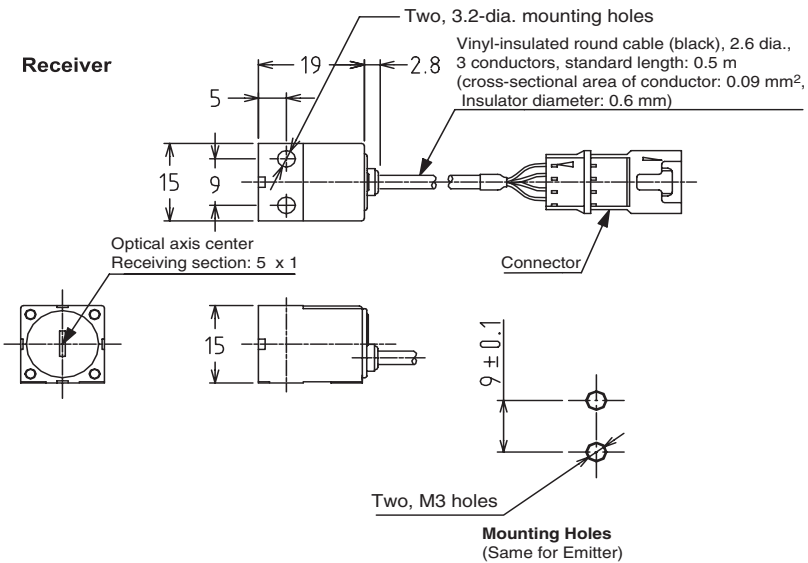
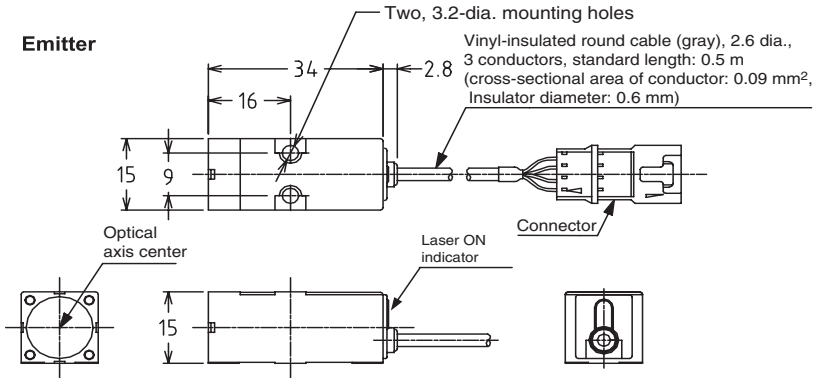

(Unit: mm)

Dimensions with ZX-XF12 Side-view Attachment Mounted

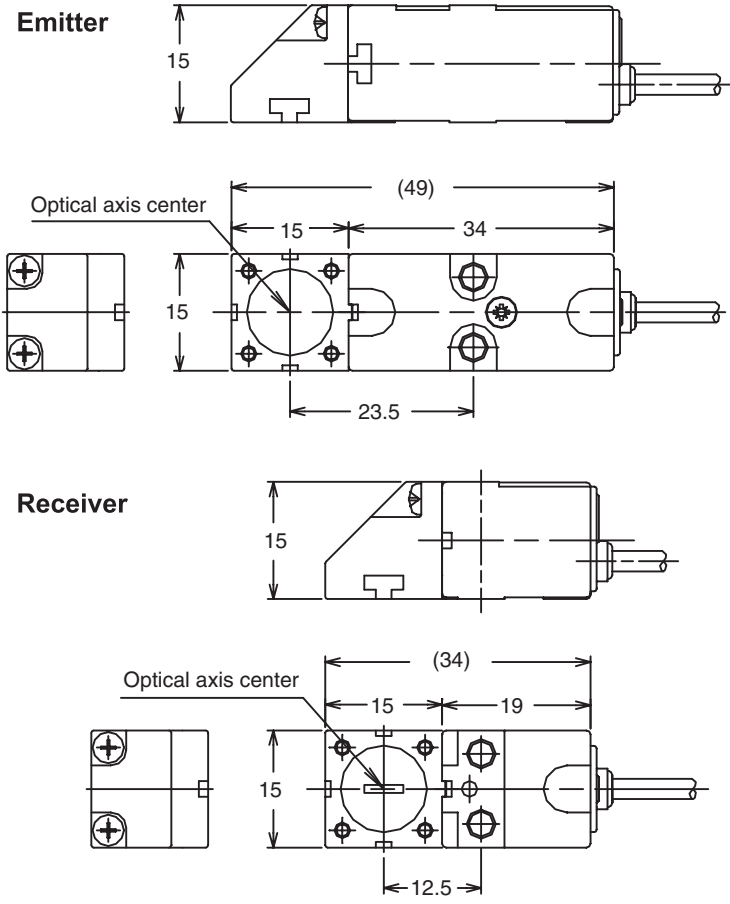

(Unit: mm)

■ ZX-LT010

Emitter

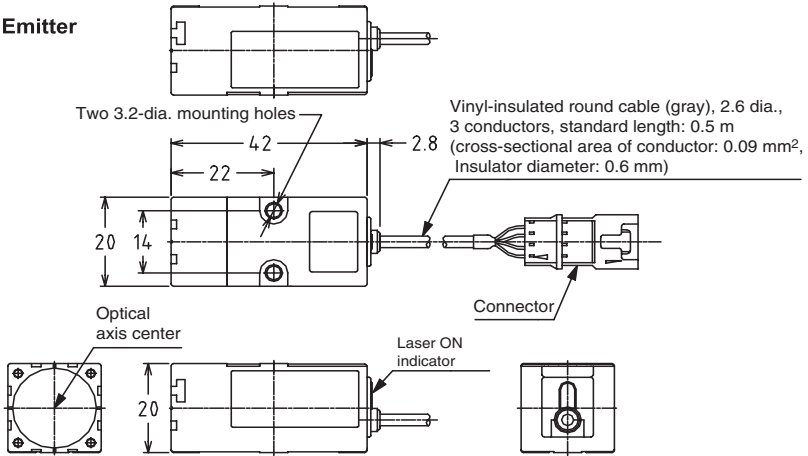

Receiver

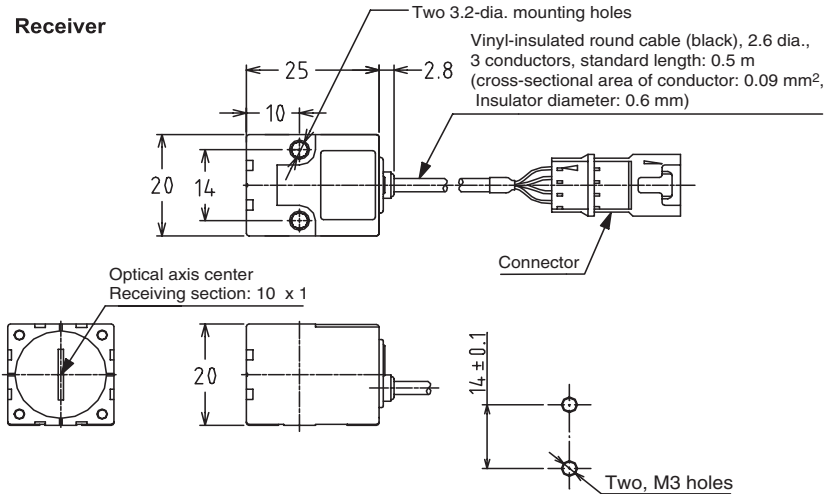

Mounting Holes
(Same for Emitter)

(Unit: mm)

Dimensions with ZX-XF22 Side-view Attachment Mounted

Emitter

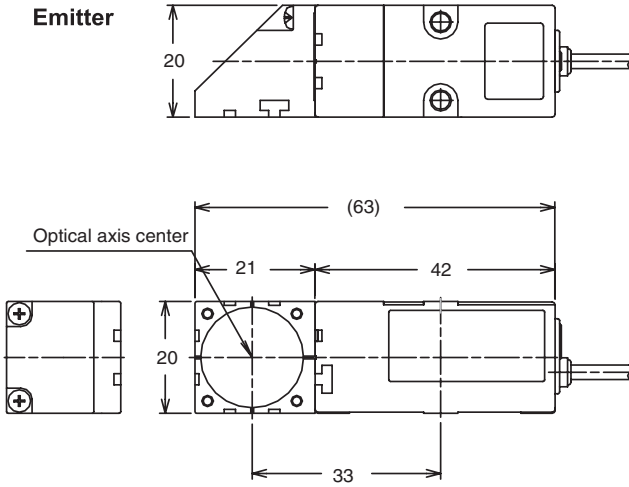

Receiver

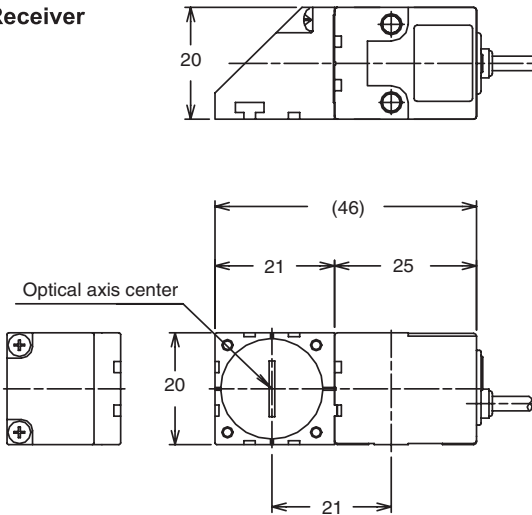

(Unit: mm)

6-2-3 Amplifier Units

■ ZX-LDA □ □

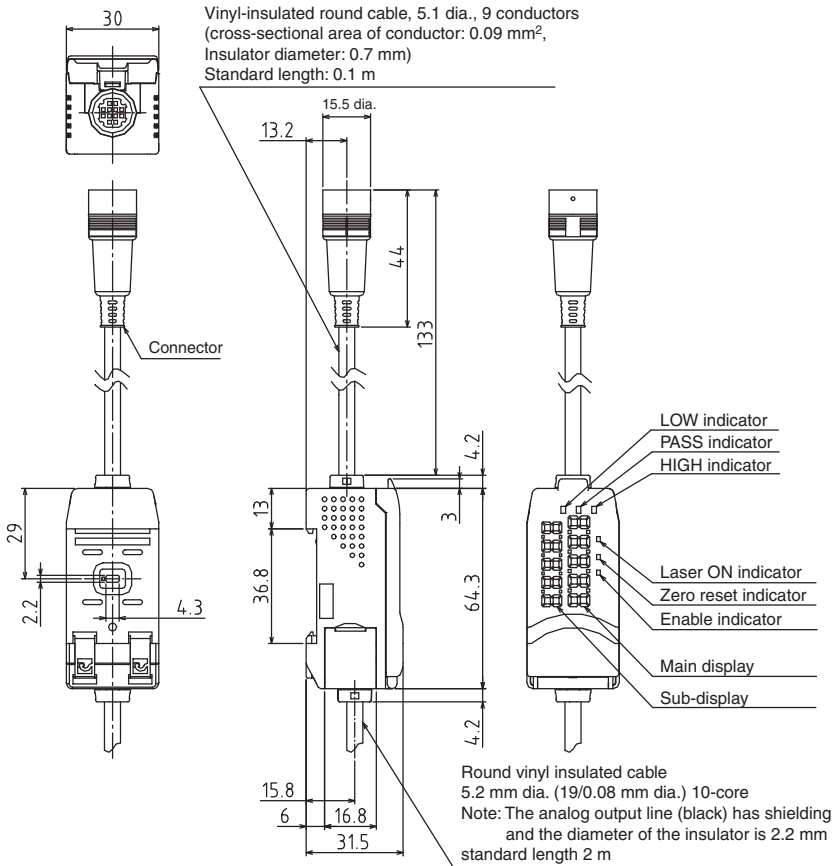

Connector Cover Dimensions when Open

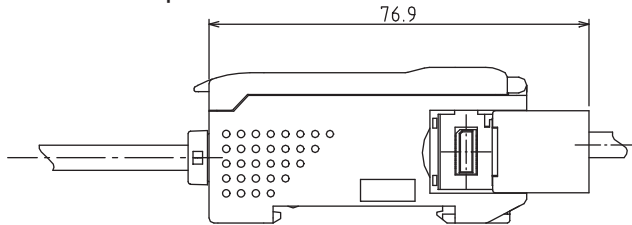

6-2-4 Calculating Unit

■ ZX-CAL

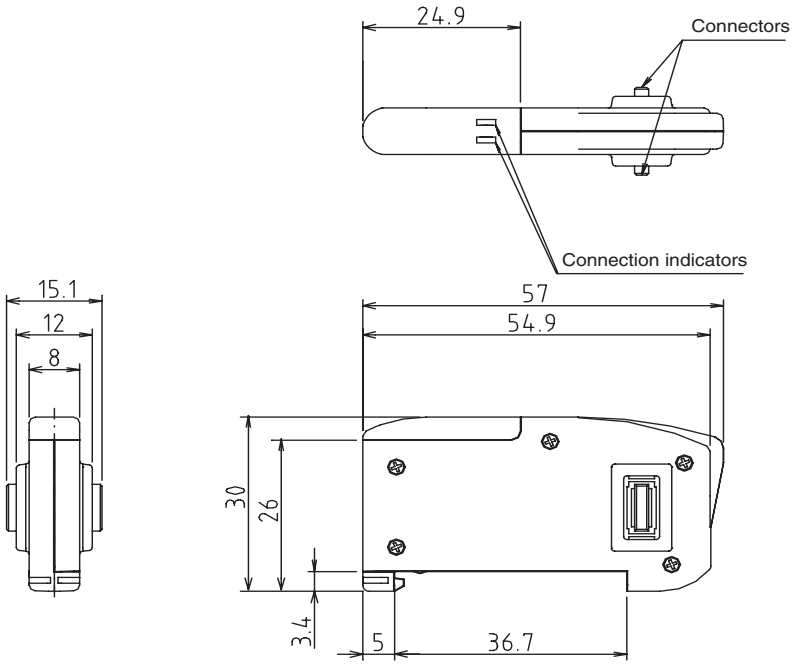

(Unit: mm)

Revision History

A manual revision code appears as a suffix to the catalog number on the front cover of the manual.

Cat. No. Z157-E1-02

↑
_____ Revision code

The following table outlines the changes made to the manual during each revision. Page numbers refer to the previous version.

Revision code	Date	Revised content
01C	July 2006	Inside front cover: Precaution removed and new material added on following pages. Page i: Signal word definitions updated. Page 11: Note added.
02	July 2015	Page xii: Added Applicable standards Page 164: Added callouts to figure.

OMRON Corporation
Industrial Automation Company

Sensing Devices Division H.Q.
Application Sensors Division
Shiokoji Horikawa, Shimogyo-ku,
Kyoto, 600-8530 Japan
Tel: (81)75-344-7068/Fax: (81)75-344-7107

Regional Headquarters
OMRON EUROPE B.V.
Sensor Business Unit,
Carl-Benz-Str. 4, D-71154 Nufringen,
Germany
Tel: (49)7032-811-0/Fax: (49)7032-811-199

OMRON ELECTRONICS LLC
1 East Commerce Drive, Schaumburg, IL 60173
U.S.A.
Tel: (1)847-843-7900/Fax: (1)847-843-8568

OMRON ASIA PACIFIC PTE. LTD.
83 Clemenceau Avenue,
#11-01, UE Square,
239920 Singapore
Tel: (65)6835-3011/Fax: (65)6835-2711

OMRON (CHINA) CO., LTD.
Room 2211, Bank of China Tower,
200 Yin Cheng Road (M)
Shanghai, 200120 China
Tel: (86)21-5037-2222/Fax: (86)21-5037-2200

Authorized Distributor: