



Machine Automation Controller NJ-series

DeviceNet™ Connection Guide

OMRON Corporation

3G3RX-V1 Series Inverter

Network
Connection
Guide

About Intellectual Property Rights and Trademarks

Microsoft product screen shots reprinted with permission from Microsoft Corporation.

Windows is registered trademark of Microsoft Corporation in the USA and other countries.

ODVA and DeviceNet™ are trademarks of ODVA.

EtherCAT® is registered trademark and patented technology, licensed by Beckhoff Automation GmbH, Germany.

Sysmac is a trademark or registered trademark of OMRON Corporation in Japan and other countries for OMRON factory automation products.

Company names and product names in this document are the trademarks or registered trademarks of their respective companies.

Table Of Contents

1. Related Manuals	1
2. Terms and Definitions	1
3. Remarks	2
4. Overview	4
5. Applicable Products and Support Software	5
5.1. Applicable Products	5
5.2. Device Configuration	6
6. DeviceNet Settings	8
6.1. DeviceNet Communications Settings	8
6.2. Allocation for Remote I/O Communications	9
7. Connection Procedure	11
7.1. Overview of Setting up Remote I/O Communications	11
7.2. Work Flow	12
7.3. Setting Up the Inverter	13
7.4. Setting Up the Controller	20
7.5. Setting Up the Network	29
7.6. Connection Status Check	35
8. Initialization Method	40
8.1. Controller	40
8.2. Inverter	41
9. Appendix 1 Details on Remote I/O Communication Settings	42
9.1. Global Variable Table	42
10. Appendix 2 Setting Procedure without the Configuration Files	44
10.1. Overview of Setting Procedure without the Configuration Files	44
10.2. Work Flow of the "Procedure for Setting Parameters from the Beginning"	45
10.3. Setting Up the Controller without the Configuration Files	47
10.4. Setting Up the Network by CX-Integrator	56
11. Revision History	64

1. Related Manuals

The table below lists the manuals that relate to this document.

To ensure system safety, make sure to always read and heed the information provided in all Safety Precautions, Precautions for Safe Use, and Precaution for Correct Use of manuals for each device which is used in the system.

Cat.No.	Model	Manual Name
W500	NJ501-□□□□ NJ301-□□□□	NJ-series CPU Unit Hardware User's Manual
W501	NJ501-□□□□ NJ301-□□□□	NJ-series CPU Unit Software User's Manual
W497	CJ1W-DRM21	CJ-series DeviceNet™ Units Operation Manual for NJ-series CPU Unit
W267	-	DeviceNet™ Operation Manual
W504	SYSMAC-SE2□□□□	Sysmac Studio Version 1 Operation Manual
W464	-	CX-Integrator Ver.2 Network Configuration Tool Operation Manual
I578	3G3RX-V1-□□□□□-V1	RX Series Type V1 High-function General-purpose Inverter User's Manual
I581	3G3AX-RX-DRT-E	MX2/RX Series DeviceNet Communications Unit User's Manual



2. Terms and Definitions

Term	Explanation and Definition
Master/Slave	<p>A master is a unit that controls the DeviceNet communications.</p> <p>A master sends output data to multiple slaves and receives input data from the slaves.</p> <p>Slaves receive output data that are sent from the master, and send input data to the master.</p> <p>At least one master is required for DeviceNet communications.</p>
EDS file	An EDS file is a file that contains the I/O points of DeviceNet slave units and the parameters that can be set via DeviceNet.
Node address (MAC ID)	A node address is an address to identify a unit connected to a DeviceNet network. With DeviceNet, a MAC (Media Access Control) ID is used as a node address. Thus, a node address is a MAC ID.
Scan list	A scan list is used to register slaves with which a master communicates in DeviceNet remote I/O communications. A master communicates with the slaves based on the scan list settings.

3. Remarks

- (1) Understand the specifications of devices which are used in the system. Allow some margin for ratings and performance. Provide safety measures, such as installing safety circuit in order to ensure safety and minimize risks of abnormal occurrence.
- (2) To ensure system safety, always read and heed the information provided in all Safety Precautions, Precautions for Safe Use, and Precaution for Correct Use of manuals for each device used in the system.
- (3) The user is encouraged to confirm the standards and regulations that the system must conform to.
- (4) It is prohibited to copy, to reproduce, and to distribute a part of or whole part of this document without the permission of OMRON Corporation.
- (5) The information contained in this document is current as of January 2013. It is subject to change without notice for improvement.

The following notation is used in this document.

 WARNING	Indicates a potentially hazardous situation which, if not avoided, will result in minor or moderate injury, or may result in serious injury or death. Additionally there may be significant property damage.
 Caution	Indicates a potentially hazardous situation which, if not avoided, may result in minor or moderate injury or in property damage.



Precautions for Safe Use

Precautions on what to do and what not to do to ensure safe usage of the product.



Application precautions

Precautions on what to do and what not to do to ensure proper operation and performance.



Additional Information

Additional information to read as required.

This information is provided to increase understanding or make operation easier.

Symbols



The circle and slash symbol indicates operations that you must not do. The specific operation is shown in the circle and explained in text. This example indicates prohibiting disassembly.



The triangle symbol indicates precautions (including warnings). The specific operation is shown in the triangle and explained in text. This example indicates a precaution for electric shock.



The triangle symbol indicates precautions (including warnings). The specific operation is shown in the triangle and explained in text. This example indicates a general precaution.



The filled circle symbol indicates operations that you must do. The specific operation is shown in the circle and explained in text. This example shows a general precaution for something that you must do.

4. Overview

This document describes the procedure for connecting the Inverter (3G3RX-V1 series) of OMRON Corporation (hereinafter referred to as OMRON) to the NJ-series Machine Automation Controller (hereinafter referred to as the Controller) via DeviceNet and provides the procedure for checking their connection.

Specifically, it describes the procedure for connecting DeviceNet using DeviceNet settings of the project files prepared beforehand (hereinafter referred to as the "procedure for using the configuration files").

Section 9 A-1 and Section 10 A-2 describe the procedures for setting parameters without the prepared configuration files (hereinafter referred to as the "procedure for setting parameters from the beginning").

To follow the "procedure for using the configuration files", prepare the latest "Sysmac Studio project file" and "CX-Integrator project file" (they are referred to as "configuration files") from OMRON in advance.

Name	File name	Version
Sysmac Studio project file (extension: SMC)	OMRON_3G3RX-V1_DN_EV100.SMC	Ver.1.00
CX-Integrator project file (extension: cin)	OMRON_3G3RX-V1_DN_EV100.cin	Ver.1.00

5. Applicable Products and Support Software

5.1. Applicable Products

The applicable devices are as follows:

Manufacturer	Name	Model	Version
OMRON	NJ-series CPU Units	NJ501-□□□□ NJ301-□□□□	Versions listed in Section 5.2 or higher versions
OMRON	DeviceNet Unit (Master)	CJ1W-DRM21	
OMRON	Inverter	3G3RX -□□□□□-V1	
OMRON	DeviceNet Communications Unit	3G3AX-RX-DRT-E	



Precautions for Correct Use

As applicable devices above, the devices with the models and versions listed in Section 5.2. are actually used in this document to describe the procedure for connecting devices and checking the connection.

You cannot use devices with versions lower than the versions listed in Section 5.2.

To use the above devices with versions not listed in Section 5.2 or versions higher than those listed in Section 5.2, check the differences in the specifications by referring to the manuals before operating the devices.



Additional Information

This document describes the procedure to establish the network connection. Except for the connection procedure, it does not provide information on operation, installation or wiring method. It also does not describe the functionality or operation of the devices. Refer to the manuals or contact your OMRON representative.

5.2. Device Configuration

The hardware components to reproduce the connection procedure of this document are as follows:

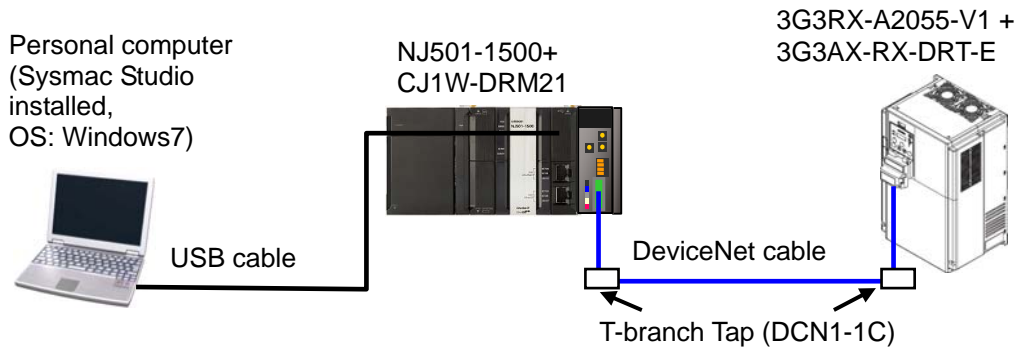

Manufacturer	Name	Model	Version
OMRON	DeviceNet Unit (Master)	CJ1W-DRM21	Ver.1.1
OMRON	CPU Unit	NJ501-1500	Ver.1.03
OMRON	Power Supply Unit	NJ-PA3001	
OMRON	DeviceNet cable	DCA1-5C10	
OMRON	T-branch Tap	DCN1-1C	
OMRON	Sysmac Studio	SYSMAC-SE2[] [] []	Ver.1.04
OMRON	CX-Integrator	(Included with Sysmac Studio)	Ver.2.55
OMRON	Sysmac Studio project file	OMRON_3G3RX-V1_DN_EV100.SMC	Ver.1.00
OMRON	CX-Integrator project file	OMRON_3G3RX-V1_DN_EV100.cin	Ver.1.00
-	Personal computer (OS: Windows 7)	-	
-	USB cable (USB 2.0 type B connector)	-	
OMRON	Inverter	3G3RX -A2055-V1	
OMRON	DeviceNet Communications Unit	3G3AX-RX-DRT-E	



Precautions for Correct Use

To use the configuration files, prepare the latest "Sysmac Studio project file" and "CX-Integrator project file" in advance.

(To obtain the files, contact your OMRON representative.)



Precautions for Correct Use

Update the Sysmac Studio to the version specified in this section or higher version using the auto update function.

If a version not specified in this section is used, the procedures described in Section 7 and subsequent sections may not be applicable. In that case, use the equivalent procedures described in the Sysmac Studio Version 1 Operation Manual (Cat.No. W504).



Additional Information

For information on the DeviceNet cable and network wiring, refer to *Chapter 2 Network Configuration and Wiring* of the *DeviceNet Operation Manual* (Cat. No. W267).

Connect a terminating resistance to each end of the trunk line of the DeviceNet.



Additional Information

In this document, a USB is used to connect with the Controller. For information on how to install a USB driver, refer to *A-1 Driver Installation for Direct USB Cable Connection* of the *Sysmac Studio Version 1 Operation Manual* (Cat.No. W504).

6. DeviceNet Settings

This section provides the specifications such as communications parameters and variables that are defined in this document.

Hereinafter, the Inverter is referred to as the "destination device" in some descriptions.

6.1. DeviceNet Communications Settings

The DeviceNet settings are shown below.

	DeviceNet Unit	Inverter
Unit number	0	-
Node address (MAC ID)	63	0
Baud rate (bps)	500 kbps	(Automatically follows the Master Unit)
Remote I/O	-	1 (Extended Speed I/O)

6.2. Allocation for Remote I/O Communications

The remote I/O communications data of the destination device are allocated to the Controller's global variables. An allocation for the remote I/O communications data is called a scan list. The relationship between the device data and the global variables is shown below. The following global variables are defined in the "configuration file".

■ Output area (Controller → Inverter)

Offset	Destination device data	Memory used for CJ-series Unit	Global variable name	Data type
+0	Command	%3200	DN00_CMD_OUT	BOOL[16]
+1	Rotation Speed Reference	%3201	DN00_DATA_OUT	WORD

■ Input area (Controller ← Inverter)

Offset	Destination device data	Memory used for CJ-series Unit	Global variable name	Data type
+0	Status information	%3300	DN00_STA_IN	BOOL[16]
+1	Rotation Speed Monitor	%3301	DN00_DATA_IN	WORD



Additional Information

For details on I/O format, refer to *Section 4 Remote I/O* in the *MX2/RX Series DeviceNet Communication Unit User's Manual* (Cat. No. I581).



Additional Information

When a DeviceNet Unit is used with a Controller, slave data are allocated to the memory used for CJ-series Units. With programs, specify variable names for the memory used for CJ-series Units.

With Sysmac Studio, add the prefix "%" to each address to indicate the memory used for CJ-series Units.

■Details on output area

Global variable	Name		Meaning
DN00_CMD_OUT[0]	FW	Forward/stop	0: Stop, 1: Forward
DN00_CMD_OUT[1]	RV	Reverse/Stop	0: Stop, 1: Reverse
DN00_CMD_OUT[2]	RS	Fault reset	0:-, 1: Fault reset
DN00_CMD_OUT[5]	CTR	Net Ctrl.	0: Follow the setting of parameter A002. 1: Follow the reference from network control.
DN00_CMD_OUT[6]	REF	Net Ref.	0: Follow the setting of parameter A001. 1: Follow the reference from network control.
DN00_DATA_OUT	Rotation Speed Reference		If parameter P049 (Number of Poles for Rotation Speed Setting) is set appropriately, the rotational speed unit is [min -1]. If parameter P049 (Number of Poles for Rotation Speed Setting) is set to 0, the frequency unit is [0.01 Hz].

■Details on input area

Global variable	Name		Meaning
DN00_STA_IN[0]	AL	Alarm output	0:Normal, 1: Fault/Trip
DN00_STA_IN[1]	WR	Warning	0: Normal, 1: Warning
DN00_STA_IN[2]	FWR	During forward operation	0: During reverse run/Stopping, 1: During forward run
DN00_STA_IN[3]	RVR	During reverse operation	0: During forward run/Stopping, 1: During reverse run
DN00_STA_IN[4]	IRDY	Operation ready	0: Not ready, 1: Ready
DN00_STA_IN[5]	CFN	Ctrl.From Net	0: Follow the setting of parameter A002. 1: DeviceNet reference
DN00_STA_IN[6]	RFN	Ref.From Net	0: Follow the setting of parameter A001. 1: DeviceNet reference
DN00_STA_IN[7]	FA1	Constant speed reached	0: Accelerating or decelerating/Stopping, 1: Frequency agree
DN00_STA_IN[8] to DN00_STA_IN[15]	Drive Status	DN00_STA_IN [15] to [11]	[10] [9] [8]
		1: Startup	0 0 0 1
		2: Not ready	0 0 1 0
		3: Ready	0 0 1 1
		4: Operation in progress	0 1 0 0
		5: Stopping	0 1 0 1
		6: Fault/Trip stop	0 1 1 0
7: Fault/Trip	0 1 1 1		
DN00_DATA_IN	Rotation Speed Reference		If parameter P049 (Number of Poles for Rotation Speed Setting) is set appropriately, the rotational speed unit is [min -1]. If parameter P049 (Number of Poles for Rotation Speed Setting) is set to 0, the frequency is monitored in units of [0.01 Hz].

7. Connection Procedure

This section describes the procedure for connecting the Controller to Inverter via DeviceNet using the "procedure for using the configuration files".

This document explains the procedures for setting up the Controller and Inverter from the factory default setting. For the initialization, refer to *Section 8 Initialization Method*.

7.1. Overview of Setting up Remote I/O Communications

The following figure shows the relationship of processes to perform DeviceNet remote I/O communications using the "procedure for using the configuration files".

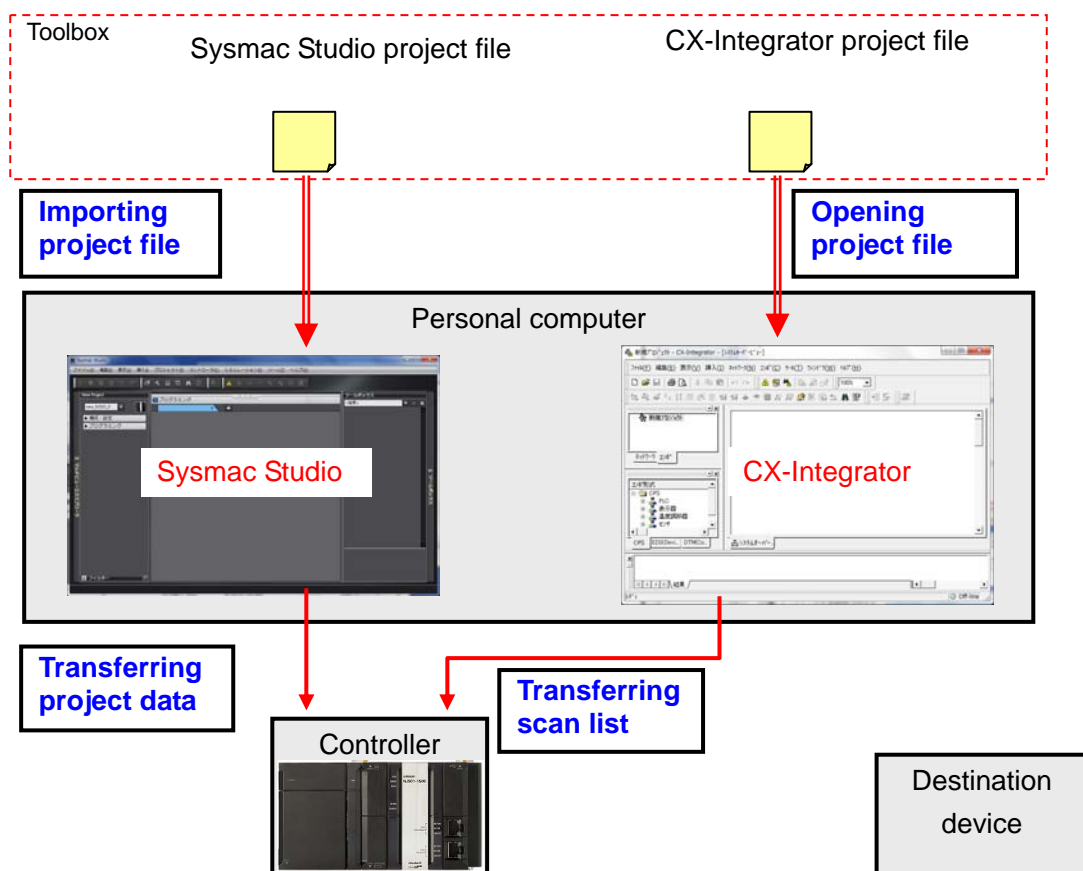

Precautions for Correct Use

Prepare the latest "Sysmac Studio project file" and "CX-Integrator project file" from OMRON in advance.

(To obtain the file, contact your OMRON representative.)

7.2. Work Flow

Take the following steps to make connection settings for remote I/O communications of DeviceNet.

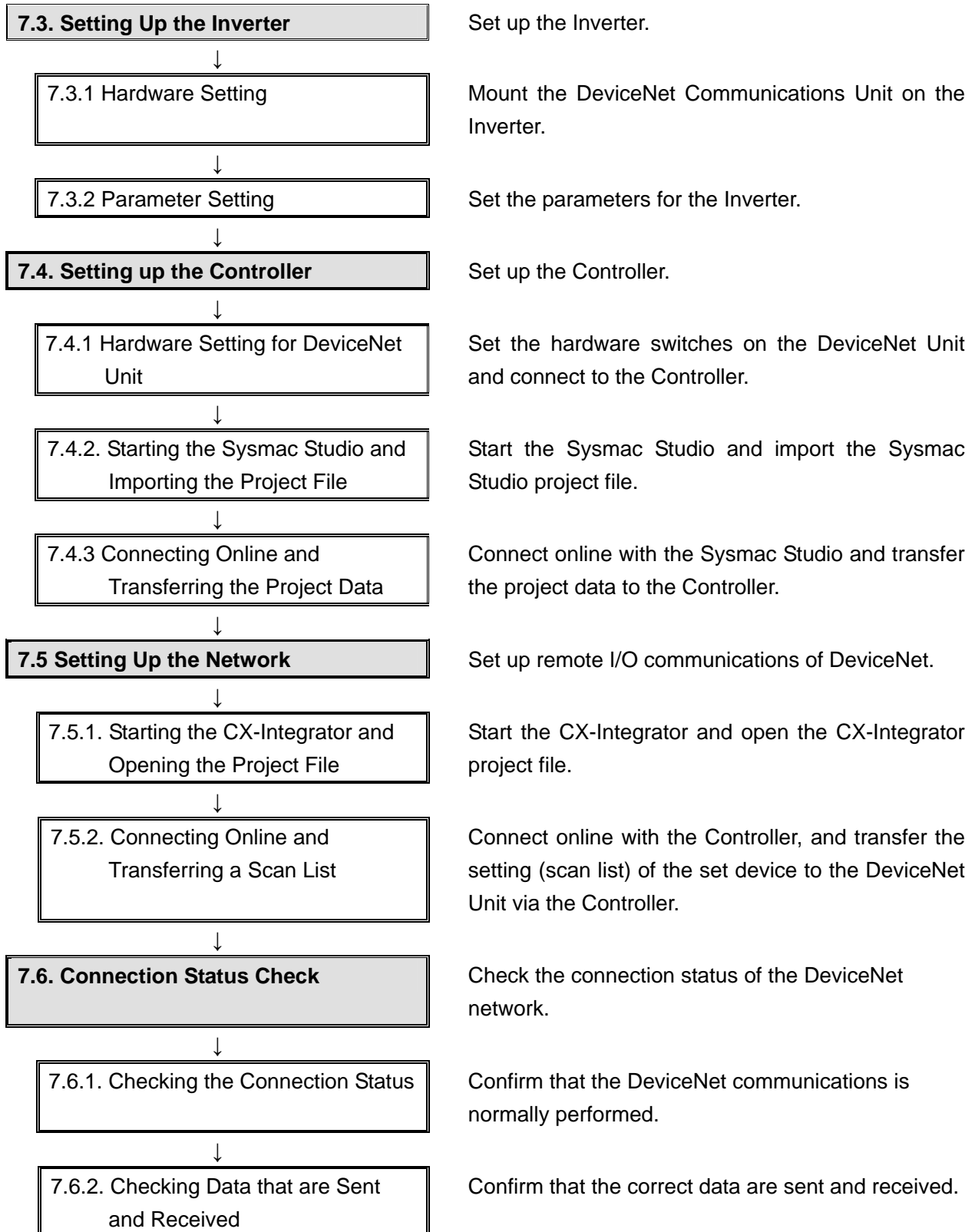

7.3. Setting Up the Inverter

Set up the Inverter.

7.3.1. Hardware Setting

Mount the DeviceNet Communications Unit on the Inverter.



Precautions for Correct Use

Make sure that the power supply is OFF when you perform the settings.

- 1 Check the name of each part on the Inverter and the DeviceNet Communications Unit by referring to the right figure.

● Inverter

- A. Digital Operator
- B. Spacer cover
- C. Terminal cover
- D. Front cover
- E. Operator connector

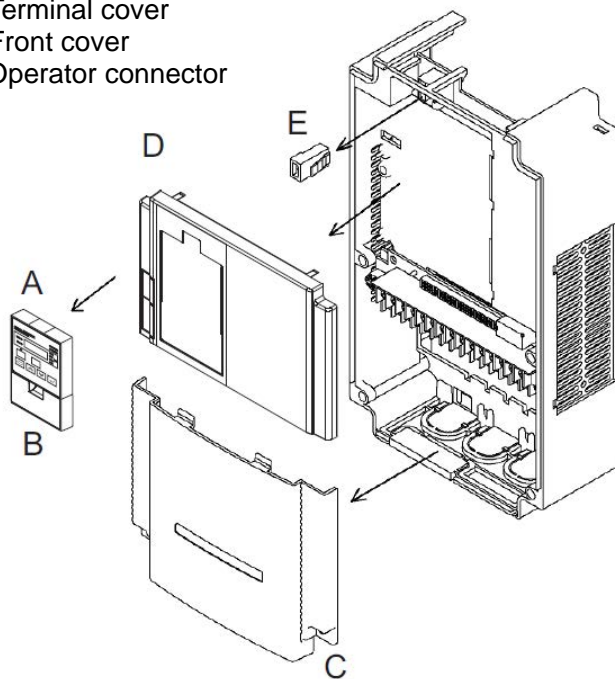

● DeviceNet Communications Unit

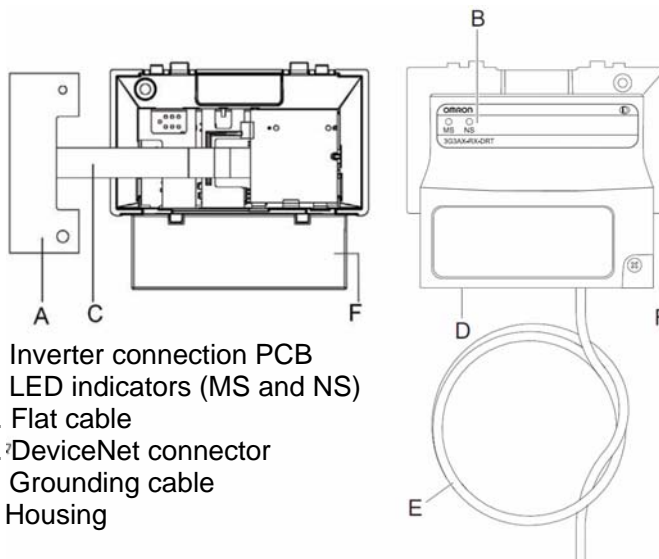

- A. Inverter connection PCB
- B. LED indicators (MS and NS)
- C. Flat cable
- D. DeviceNet connector
- E. Grounding cable
- F. Housing

- 2 Mount the DeviceNet Communications Unit on the Inverter.
- *For the mounting procedure of the DeviceNet Communications Unit, refer to 2-2-2 *Mounting Procedure of DeviceNet Communications Unit on RX-series Inverter* in the *MX2/RX Series DeviceNet Communication Unit User's Manual* (Cat. No. I581).

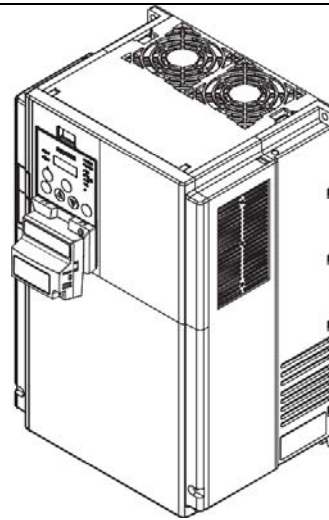

- 3 Connect the power supply to the main power supply input terminal.
- *The location of the power supply input terminal differs depending on the model. Refer to 2-3-4 *Wiring for Main Circuit Terminals* in the *RX Series Type V1 High-function General-purpose Inverter User's Manual* (Cat. No. I578).

7.3.2. Parameter Setting

Set the parameter (node address) for the Inverter.



Additional Information

Make sure that DeviceNet is not connected when you perform the setting up.

- 1 Turn ON the power supply to the Inverter.

*Set the parameter by using the Digital Operator on the front of the Inverter.

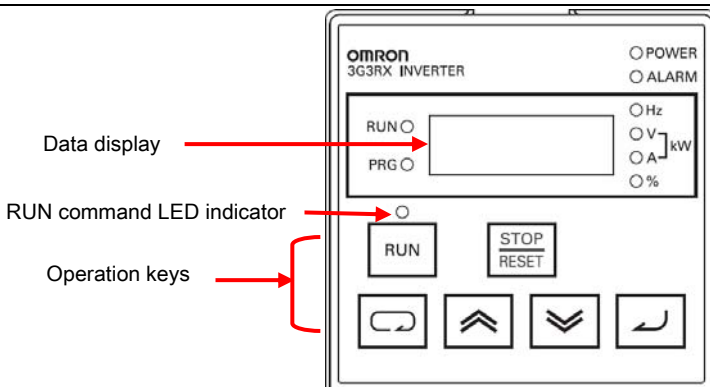

	Data display	Displays the frequency reference value, output current value or set value, or other relevant data.
	RUN key	Runs the Inverter. This key is enabled when RUN Command Selection is set to Digital Operator. (Check that the RUN command LED indicator is lit.)
	STOP/RESET key	Decelerates to stop the inverter. This key is used to reset an error when an error is occurring in the Inverter.
	Mode key	Switches between Monitor Mode (d [] [] []), Basic Function Mode (F000) and Extended Function Mode (A [] [] [], b [] [] [], C [] [] [], H [] [] []).
	Enter key	Enters the set value. (Make sure to press this key when you change the set value.)
	Increment Key	Switches each mode. This Key is also used to increment the set value of each function.
	Decrement Key	Switches each mode. This Key is also used to decrement the set value of each function.

2 When you turn ON the power supply, the display shows data as shown on the right. Set the parameters by using the procedure on the right.

0.00

After turning ON the power supply, the display shows data. (By default, the display shows the data of d001 (Output Frequency Monitor).)



Press the Mode Key three times.

[A001] Frequency Reference
Selection 1: 05
[A002] RUN Command
Selection 1: 05

A001

Parameter A001 is displayed.



Press the Enter Key.

*Set 05 (Option 2).

02

The default data is displayed.



Press the Increment Key three times.

05

The data is changed to 05.



Press the Enter Key.

A001

The parameter is displayed again.



Press the Increment Key once.

A002

Parameter A002 is displayed.



Press the Enter Key.

02

The default data is displayed.



Press the Increment Key three times.

05

The data is changed to 05.



Press the Enter Key.

A002

The parameter is displayed again.

3 Set the parameter by using the procedure on the right.

[C102] Reset selection: 03

*Set 03 (Trip reset only). By setting this value, the communications connection is not reset even if the Inverter is reset.

A002

The parameter is displayed.



Press the Mode Key twice.

C001

Parameter C001 is displayed.



Press the Increment Key and display C102.

C102

Parameter C102 is displayed.



Press the Enter Key.

02

The default data is displayed.



Press the Increment Key once.

03

The data is changed to 03.



Press the Enter Key.

C102

The parameter is displayed again.

<p>4 Check the parameter by using the procedure on the right.</p>		<p>The parameter is displayed.</p>
<p>[P046] Assembly Instance Number : 1 (Default value: Extended Speed I/O)</p>		<p>Press the Mode Key twice.</p>
<p>*Confirm that the default value (1: Extended Speed I/O) is set.</p>		<p>Parameter P001 is displayed.</p>
		<p>Press the Increment Key to display P046.</p>
		<p>Parameter P046 is displayed.</p>
		<p>Press the Enter Key.</p>
		<p>The default data is displayed.</p>
		<p>Press the Enter Key.</p>
		<p>The parameter is displayed again.</p>
<p>5 Set the parameter by using the procedure on the right.</p>		<p>The parameter is displayed.</p>
<p>[P192] DeviceNet MAC ID: 00 *Set the node address to 00.</p>		<p>Press the Increment Key to display P192.</p>
		<p>Parameter P192 is displayed.</p>
		<p>Press the Enter Key.</p>
		<p>The default data is displayed.</p>
		<p>Press the Decrement Key.</p>
		<p>The data is changed to 00.</p>
		<p>Press the Enter Key.</p>
		<p>The parameter is displayed again.</p>

6 Turn OFF the power supply to the Inverter.

Connect the DeviceNet cable.

Cycle the power supply to the Inverter.

*To to enable the changes described above, make sure to cycle the power supply to the Inverter.

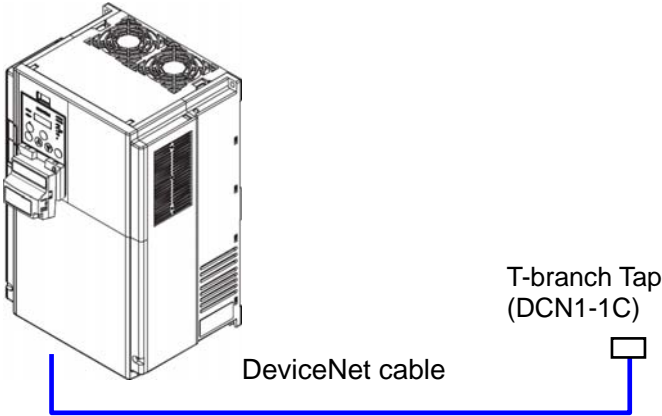

7.4. Setting Up the Controller

Set up the Controller.

7.4.1. Hardware Setting for DeviceNet Unit

Set the hardware switches on the DeviceNet Unit and connect to the Controller.



Precautions for Correct Use

Make sure that the power supply is OFF when you perform the setting up.

- 1 Make sure that the power supply to the Controller is OFF.

*If the power supply is turned ON, settings may not be applicable as described in the following procedure.

- 2 Check the hardware switches on the front panel of the DeviceNet Unit by referring to the right figure.

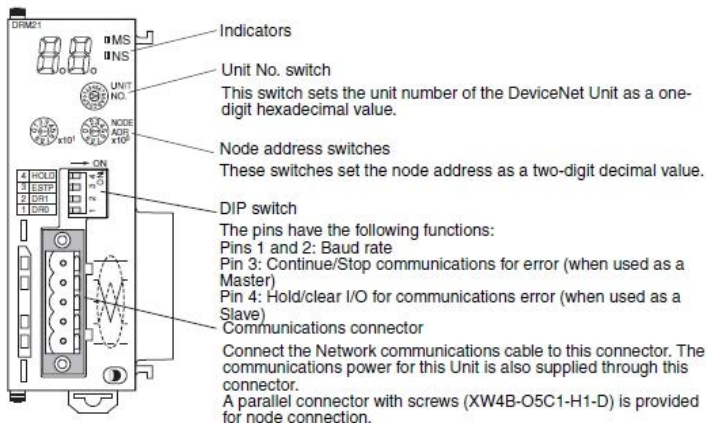

- 3 Set the Unit No. Switch to 0.



Setting method: One-digit hexadecimal

Setting range: 0 to F

Note: The unit number is set to 0 at the factory.

- 4 Set the Node Address Switches to 63.



Setting method: Two-digit decimal

Setting range: 0 to 63

Note: The node address is set to 63 at the factory.

5 Set pin 2 of the DIP switch to ON. (Set pins 1, 3 and 4 of the DIP switch to OFF.)

*The baud rate is set to 500 kbps.

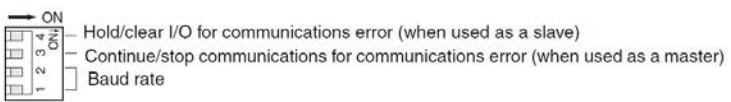

Pin	Function	Setting
1	Baud rate	See the next table.
2		
3	Continue/stop remote I/O communications for communication errors (when used as a master)	OFF: Continue communications ON: Stop communications
4	Hold/clear remote outputs for communications error (when used as a slave)	OFF: Clear remote outputs ON: Hold remote outputs

Pin 1	Pin 2	Baud rate
OFF	OFF	125 kbps
ON	OFF	250 kbps
OFF	ON	500 kbps
ON	ON	Not allowed.

All pins are set to OFF at the factory.

6 Connect the Controller to the DeviceNet Unit. Connect the personal computer, Inverter and Controller using the DeviceNet cable and USB cable as shown in 5.2 Device Configuration. Turn ON the power supply to the Controller and DeviceNet.

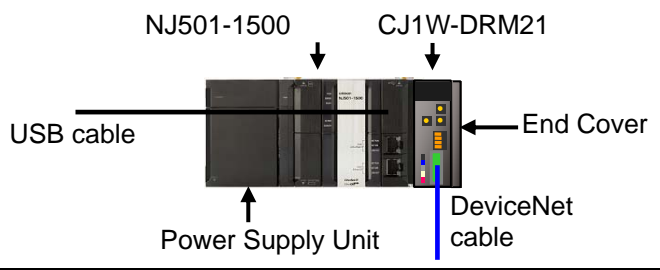

7.4.2. Starting the Sysmac Studio and Importing the Project File

Start the Sysmac Studio, and import the Sysmac Studio project file.
Install the Sysmac Studio and USB driver in the personal computer beforehand.

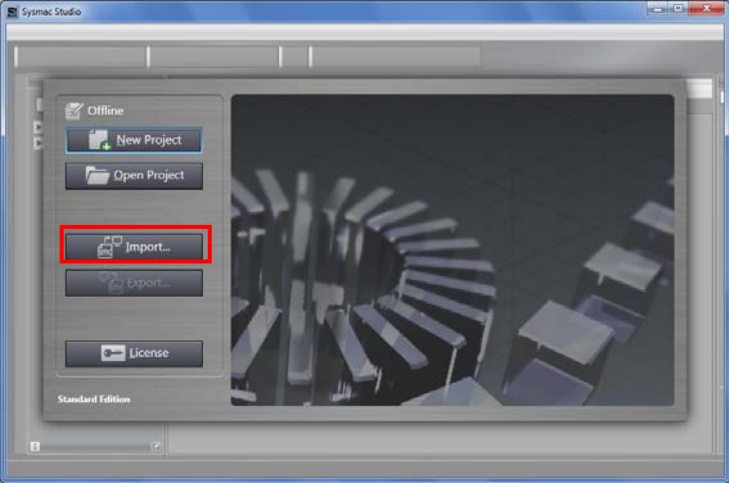
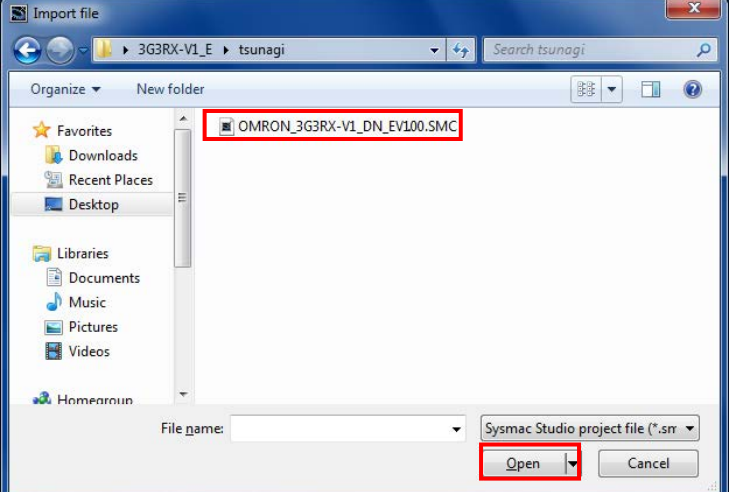
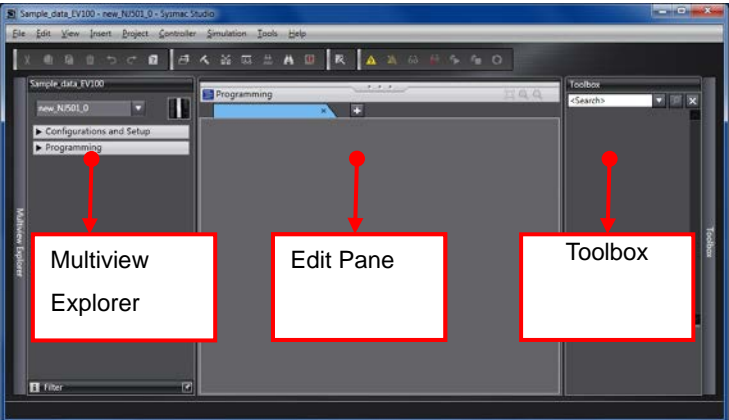
<p>1 Start the Sysmac Studio. Click the Import Button.</p> <p>*If a confirmation dialog for an access right is displayed at start, select to start.</p>	
<p>2 The Import File Dialog Box is displayed. Select OMRON_3G3RX-V1_DN_EV100.SMC (Sysmac Studio project file) and click the Open Button.</p> <p>*Obtain the Sysmac Studio project file from OMRON.</p>	
<p>3 OMRON_3G3RX-V1_DN_V100 project is displayed. The left pane is called Multiview Explorer, the right pane is called Toolbox and the middle pane is called Edit Pane.</p> <p>*If an error dialog box is displayed, check the version of the Sysmac Studio.</p>	

- 4 Double-click **CPU/Expansion Racks** under **Configurations and Setup** in the Multiview Explorer, and select the DeviceNet Unit.
Confirm that CJ1W-DRM21 is displayed and the unit number is 0 as shown in the right figure.

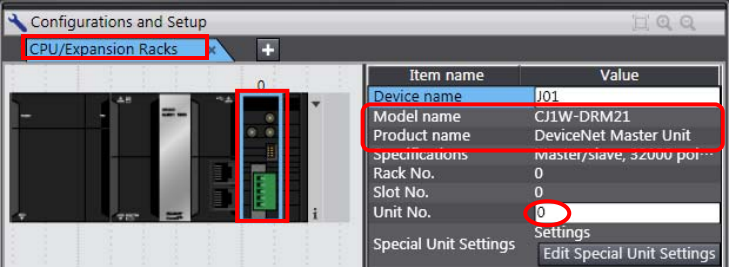
- 5 Select **Check All Programs** from the Project Menu.

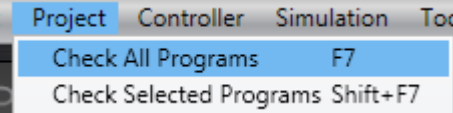
- 6 The Build Tab Page is displayed in the Edit Pane.
Confirm that "0 Errors" and "0 Warnings" are displayed.

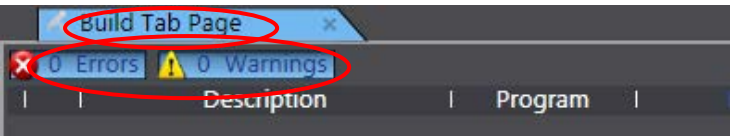
- 7 Select **Rebuild Controller** from the Project Menu.

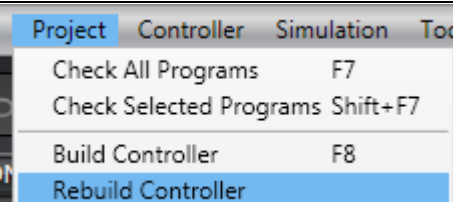
- 8 Confirm that "0 Errors" and "0 Warnings" are displayed in the Build Tab Page.

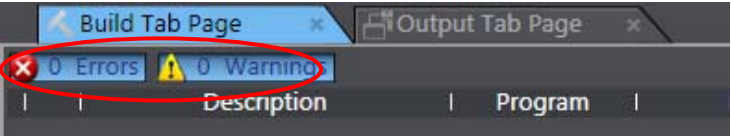

7.4.3. Connecting Online and Transferring the Project Data

Connect online with the Sysmac Studio and transfer the project data to the Controller.

⚠ WARNING

Always confirm safety at the destination node before you transfer a user program, configuration data, setup data, device variables, or values in memory used for CJ-series Units from the Sysmac Studio.

The devices or machines may perform unexpected operation regardless of the operating mode of the CPU Unit.



⚠ Caution

Always confirm safety before you reset the Controller or any components.



- 1 Select **Change Device** from the Controller Menu.

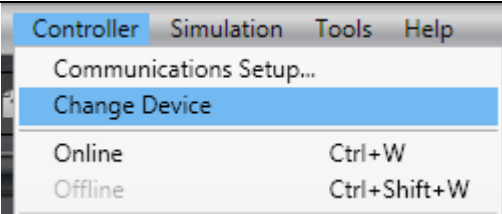

- 2 The Change Device Dialog Box is displayed. Confirm that Device and Version are set.

*If the settings are incorrect, select the setting items from the pull-down list.

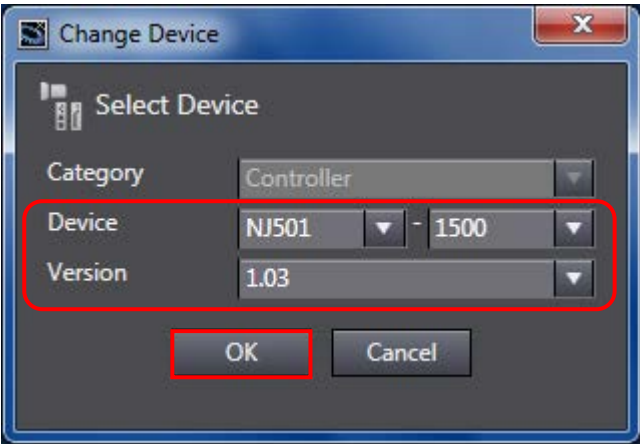
Click the **OK** Button.

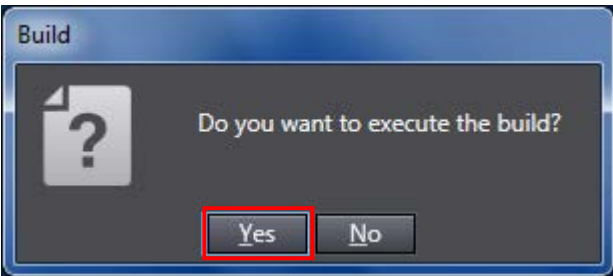
- 3 If the setting is changed in step 2, the Build Dialog Box is displayed. Click the **Yes** Button.

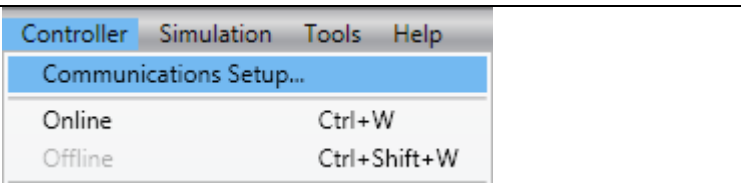
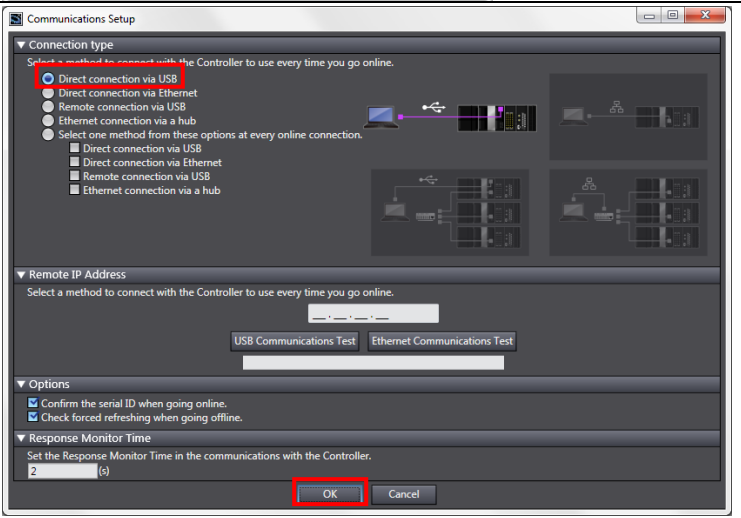
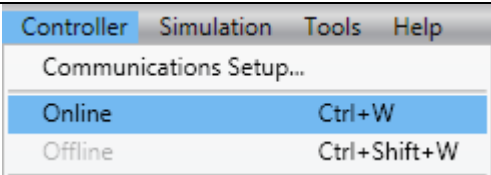
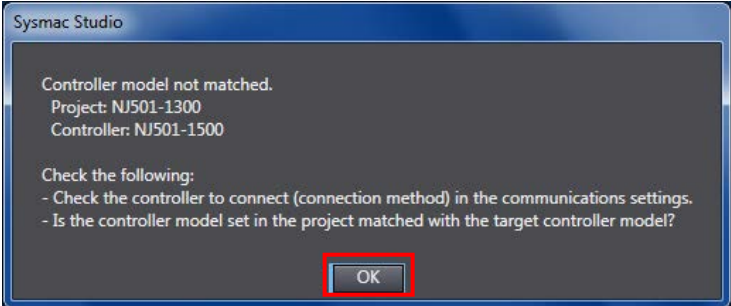
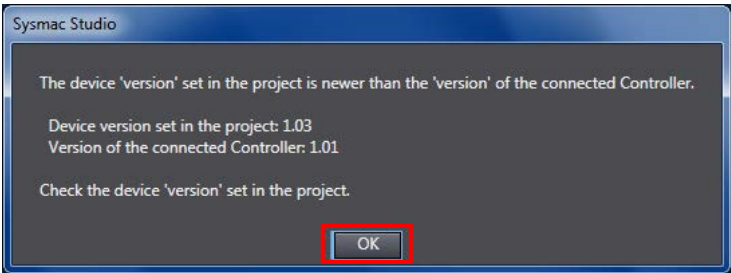

<p>4 Select Communications Setup from the Controller Menu.</p>	
<p>5 The Communications Setup Dialog Box is displayed. Select the <i>Direct connection via USB</i> Option in the Connection Type Field.</p> <p>Click the OK Button.</p>	
<p>6 Select Online from the Controller Menu.</p> <p>*If the dialog on the right is displayed, the model or version of the Controller does not match that of the project file. Check the model and version of the Controller and the device settings of the project file, return to step 1 and try again. Click the OK Button to close the dialog box.</p>	  

7 A confirmation dialog box is displayed. Click the **Yes** Button.

*The displayed dialog depends on the status of the Controller used. Click the **Yes** Button to proceed with the processing.

*The displayed serial ID differs depending on the device.

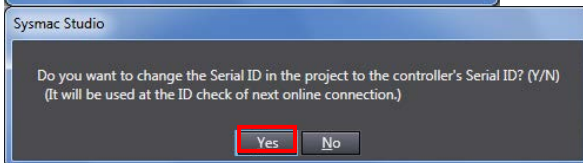
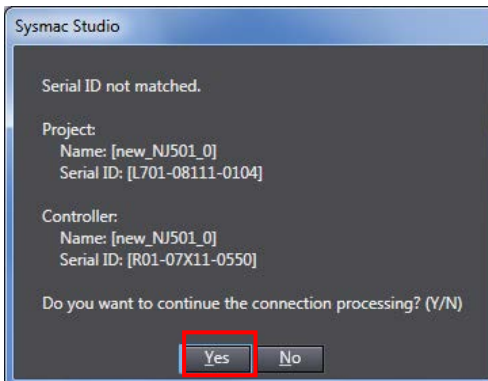
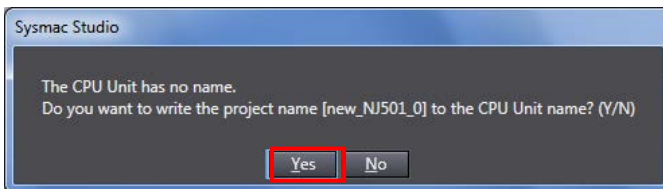

Additional Information

Refer to *Section 5 Online Connections to a Controller* in the *Sysmac Studio Version 1 Operation Manual* (Cat. No. W504) for details on online connections to a Controller.

8 When an online connection is established, a yellow bar is displayed on the top of the Edit Pane.



9 Select **Synchronization** from the Controller Menu.

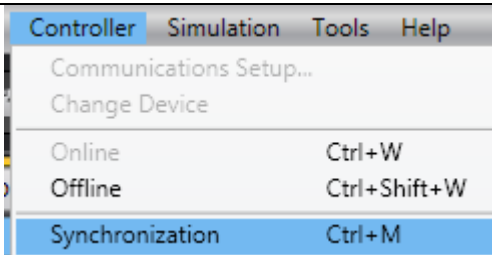

10 The Synchronization Dialog Box is displayed. Confirm that the data to transfer (NJ501 in the right figure) is selected. Then, click the **Transfer to Controller** Button.

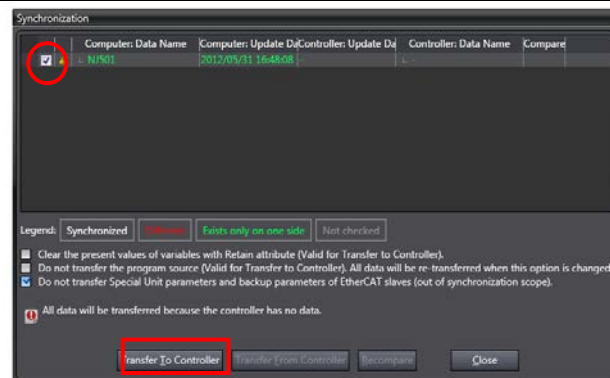

11 A confirmation dialog is displayed. Click the **Yes** Button.

A screen stating "Synchronizing" is displayed.

A confirmation dialog box is displayed. Click the **Yes** Button.

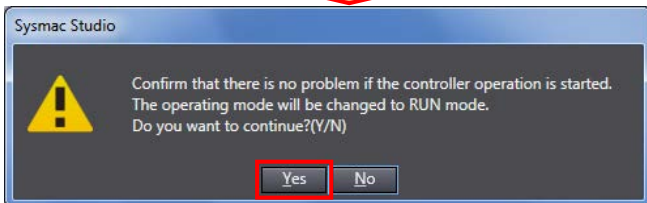
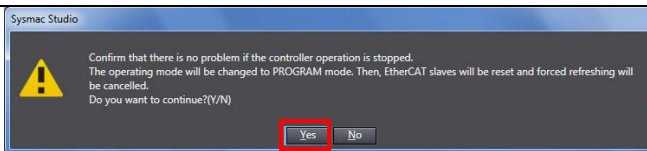

12 Confirm that the synchronized data is displayed with the color specified by "Synchronized" and that a message is displayed stating "The synchronization process successfully finished".

If there is no problem, click the **Close** Button.

*If the synchronization fails, check the wiring and try again from step 1.

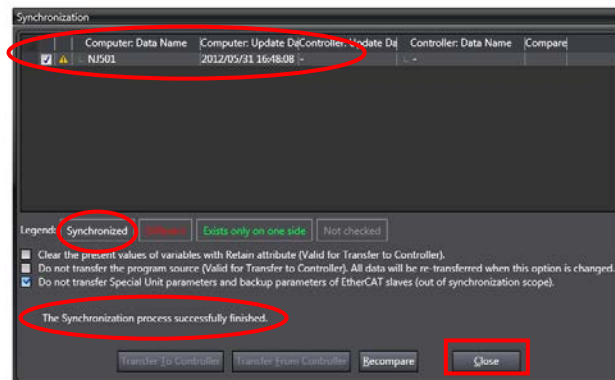

13 Select **Reset Controller** from the Controller Menu.

*When Mode is set to RUN Mode, Reset Controller cannot be selected. In this case, select **Mode - PROGRAM Mode** from the Controller Menu to change to PROGRAM mode and follow the procedure in this step.

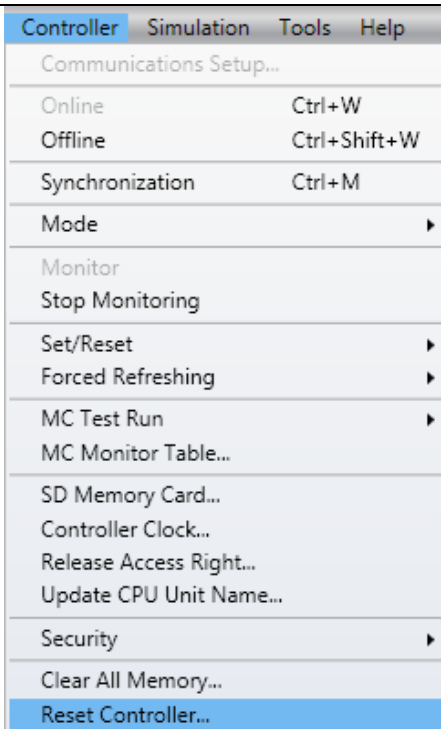

14 A confirmation dialog box is displayed several times. Click the **Yes** Button.

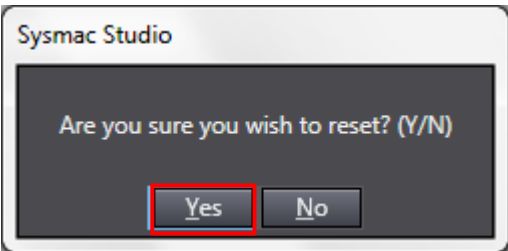
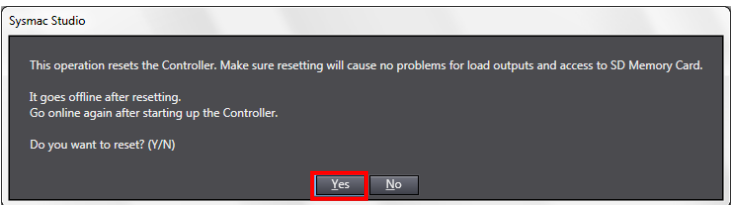

15 The Controller is reset, and Sysmac Studio goes offline. The yellow bar on the top of the Edit Pane disappears. Use steps 6 to 8 to go online.



7.5. Setting Up the Network

Set up remote I/O communications of DeviceNet.

7.5.1. Starting the CX-Integrator and Opening the Project File

Start the CX-Integrator and open the CX-Integrator project file.

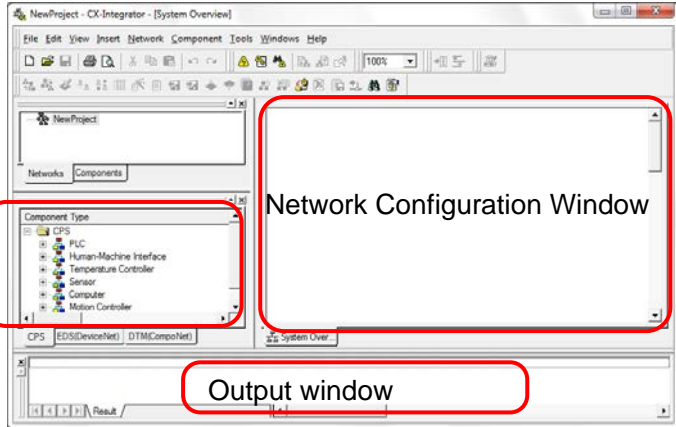
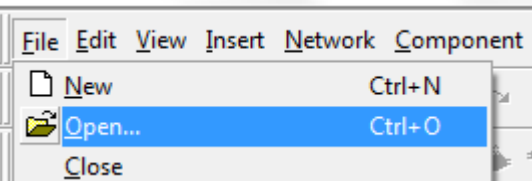
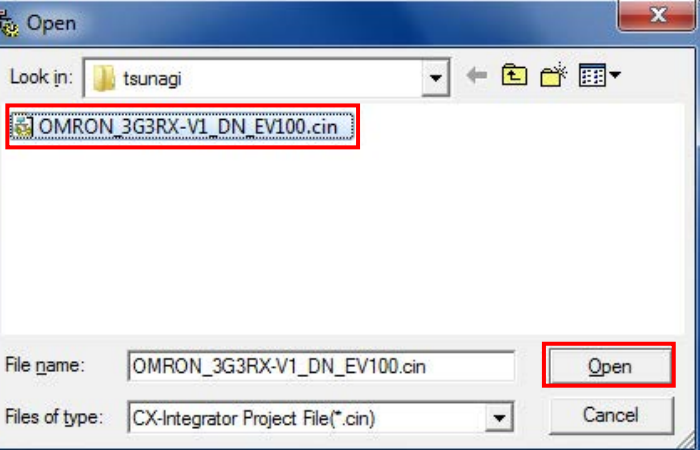
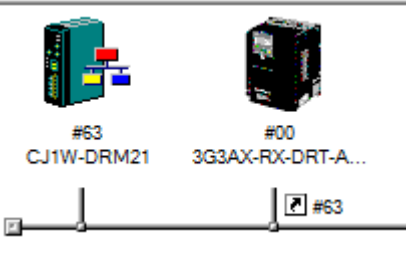
<p>1 Start the CX-Integrator.</p> <p>*If the Component List Window is not displayed, select Windows - Component List Window from the View Menu.</p> <p>Component List Window</p>	
<p>2 Select Open from the File Menu.</p>	
<p>3 The Open Dialog Box is displayed. Select OMRON_3G3RX-V1_DN_EV100.cin (CX-Integrator project file) and click the Open Button.</p>	
<p>4 The following devices are displayed in the Network Configuration Pane as shown on the right figure.</p> <p>#63: CJ1W-DRM21 #00: 3G3AX-RX-DRT- A2055</p>	



Precautions for Correct Use

Please confirm that the DeviceNet cable is connected before proceeding to the following procedures.

If it is not connected, turn OFF the power to the devices, and then connect the DeviceNet cable.

7.5.2. Connecting Online and Transferring the Scan List

Connect online with the Controller, and transfer the setting (scan list) of the device configuration to the DeviceNet Unit via the Controller. When the transfer is completed, remote I/O communications start automatically.

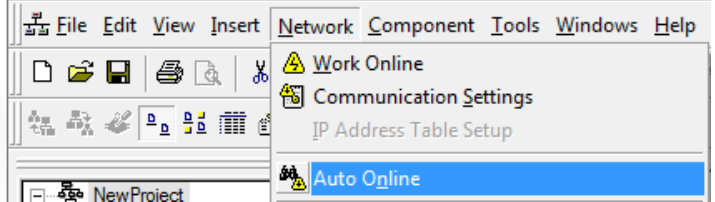
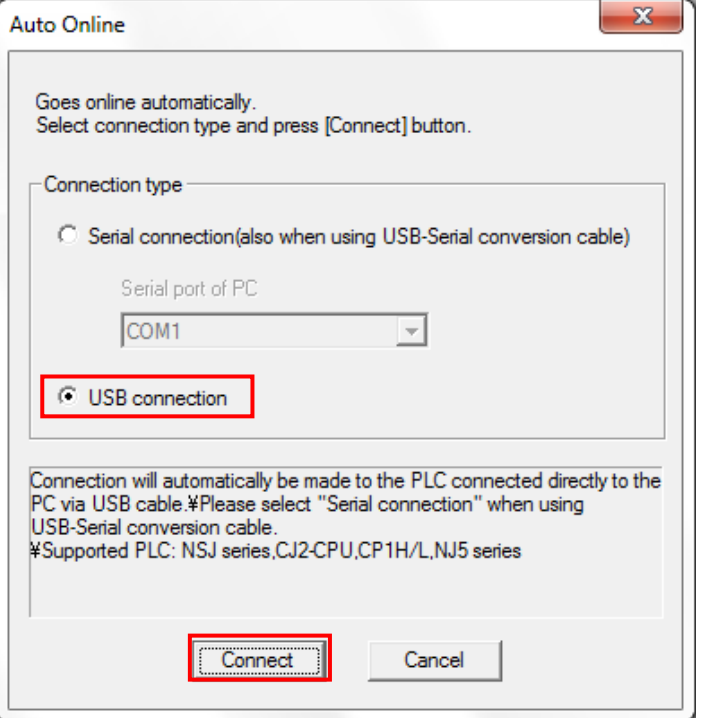
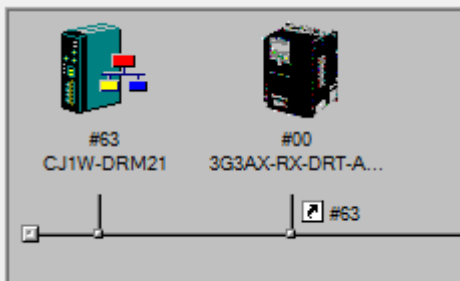
<p>1 Select Auto Online from the Network Menu.</p>	
<p>2 The Auto Online Dialog Box is displayed. Select the USB connection Option in the Connection type Field, and click the Connect Button.</p>	
<p>3 After an online connection is established, the background color of the Network Configuration Window changes as shown in the right figure.</p>	



Precautions for Correct Use

If an online connection cannot be made to the Controller, check the cable connection. Or, return to step 1, check the settings such as a connection type and try again.





Additional Information

For details on the online connections to a Controller, refer to *Section 2 Basic Operations in the Communications of the CX-Integrator Ver.2.[.] Operation Manual (Cat. No. W446)*.

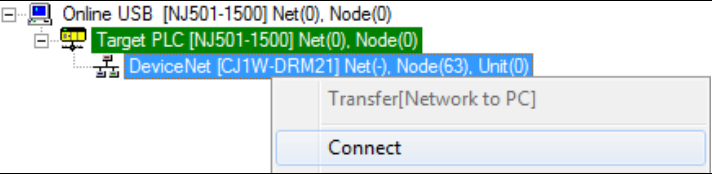
- 4 Right-click DeviceNet in the Online Connection Information Window, and select **Connect**.

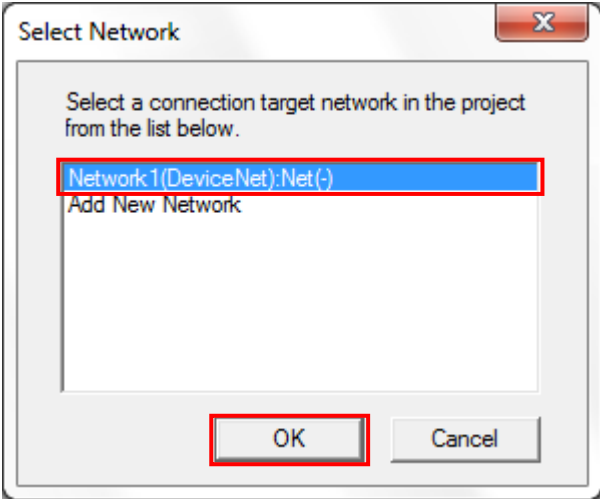
- 5 Select DeviceNet in the Select Network Dialog Box, and click the **OK** Button.

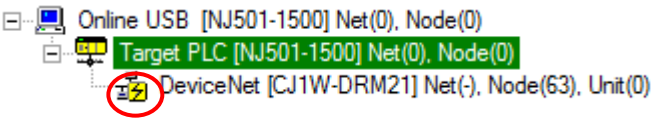

- 6 Confirm that the DeviceNet is in online status ( icon) in the Online Connection Information Window.

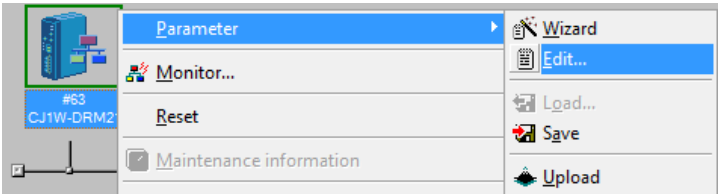
- 7 Right-click *CJ1W-DRM21* on the Network Configuration Window, and select **Parameter - Edit**.

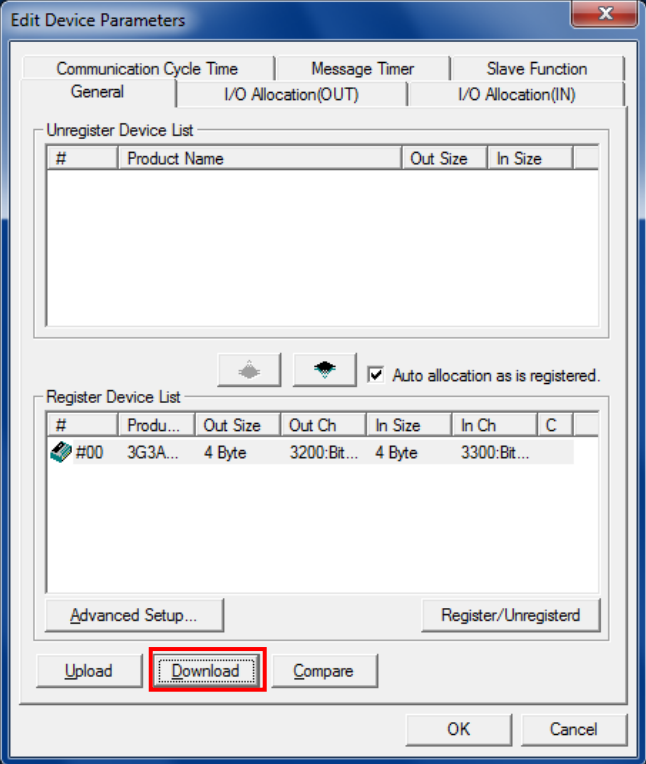

- 8 The Edit Device Parameters Dialog Box is displayed. Click the **Download** Button.

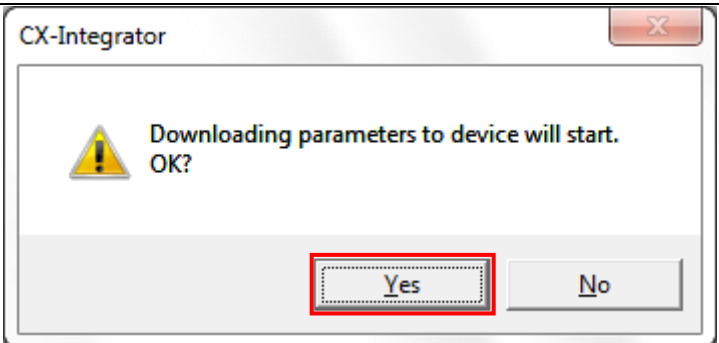

9 A download confirmation dialog box is displayed. Click the **Yes** Button to download the parameters.

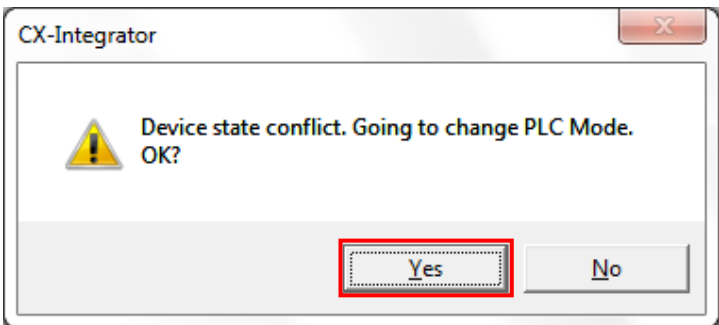

10 A dialog box is displayed confirming whether to change the mode. Click the **Yes** Button.



A dialog box is displayed indicating downloading is being performed.

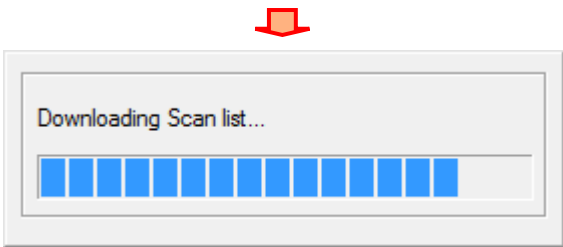

When downloading is completed, a dialog box is displayed confirming whether to change the mode. Click the **Yes** Button.

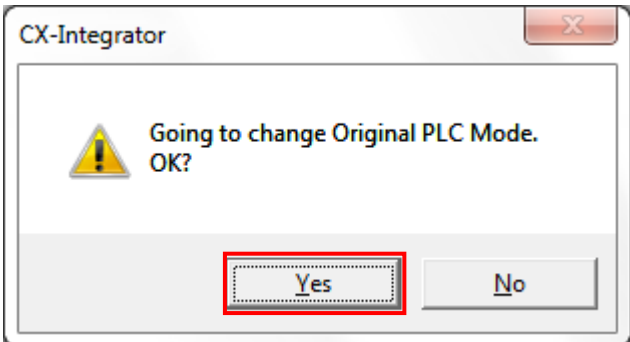

11 The Edit Device Parameters Dialog Box is displayed again. Click the **Compare** Button.

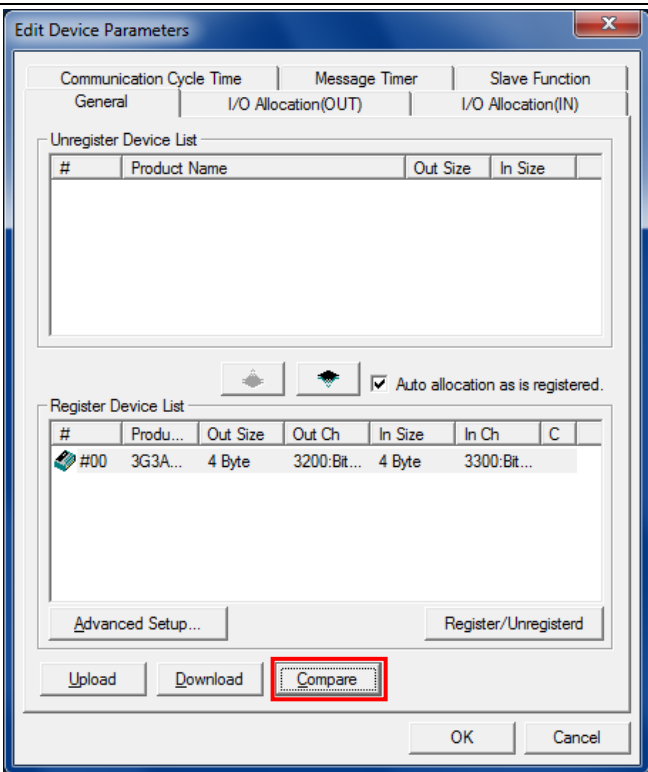

12 A dialog box shown on the right is displayed. Click the **Yes** Button to compare the parameters.

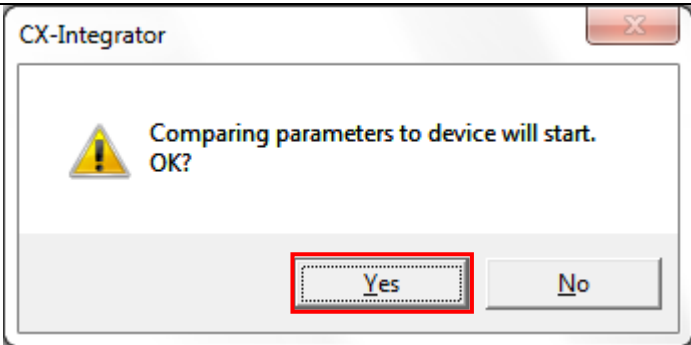

When the comparison is completed, a dialog box shown on the right is displayed. Click the **OK** Button.

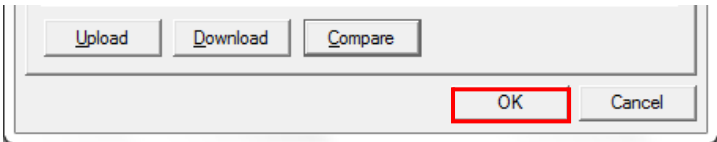
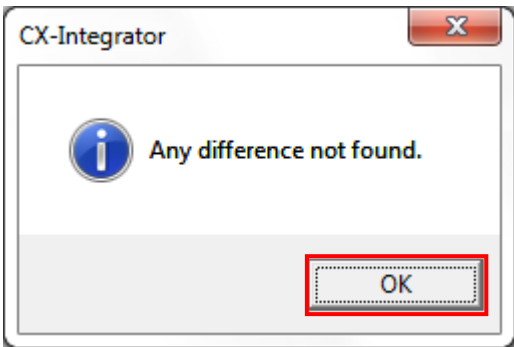

The Edit Device Parameters Dialog Box is displayed again. Click the **OK** Button.

7.6. Connection Status Check

Check the connection status of the DeviceNet network.

7.6.1. Checking the Connection Status

Confirm that the DeviceNet communications is working.

- 1 Confirm that the DeviceNet communications is performed normally by checking the LED indicators on each unit.
- DeviceNet Unit
 - LED indicators in normal status
 - MS: Lit green
 - NS: Lit green
 - During normal operation, the 7-segment display shows 63. (63: Master node address, remote I/O communications active and normal)

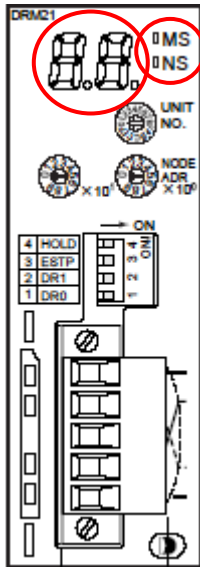

(DeviceNet Unit)

- Inverter
 - LED indicators in normal status
 - MS: Lit green
 - NS: Lit green

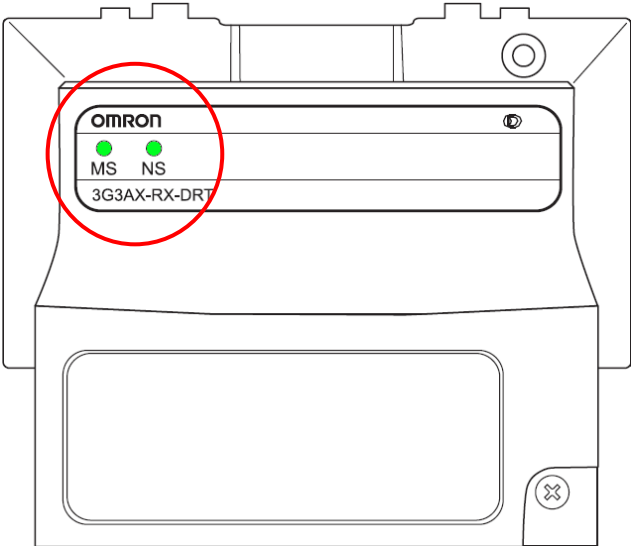

(Inverter)

- 2 Confirm that the DeviceNet communications are performed normally from the CX-Integrator by referring to the status information on the Monitor Device Dialog Box.

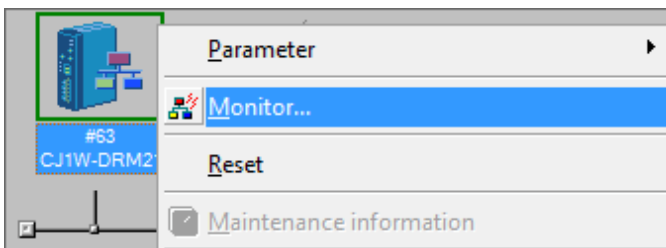

Right-click the master icon on the Network Configuration Window, and select **Monitor**.

- 3 The figure on the right shows the Status Tab Page of the Monitor Device Dialog Box.

DeviceNet communications are normally performed if the same items are selected in the Master Status Field, #00 is lit blue in the Slave Status Field, and the *Remote I/O Communications Running* Check Box is selected.

Click the **Close** Button.

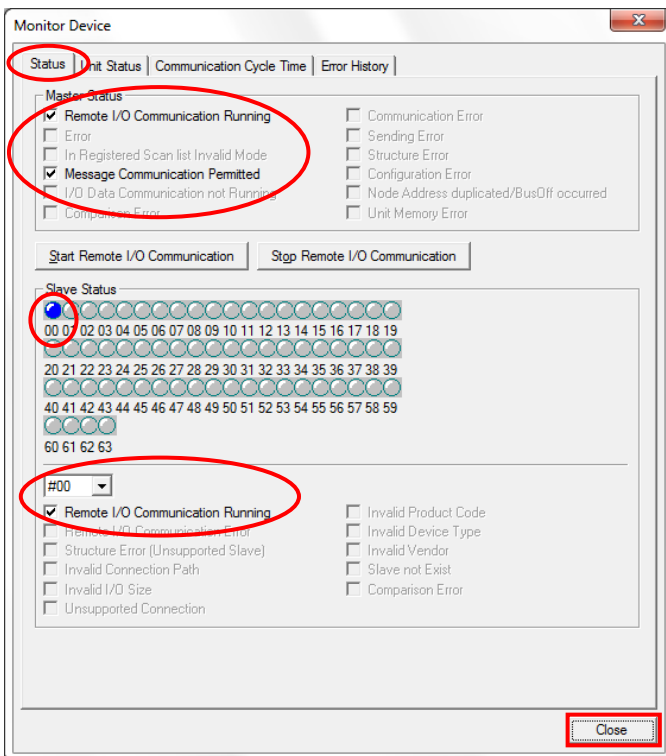

(Monitor Device Dialog Box)

- 4 Go offline with the CX-Integrator. Select **Work Online** from the Network Menu.

*The  icon is not pressed during offline connection.

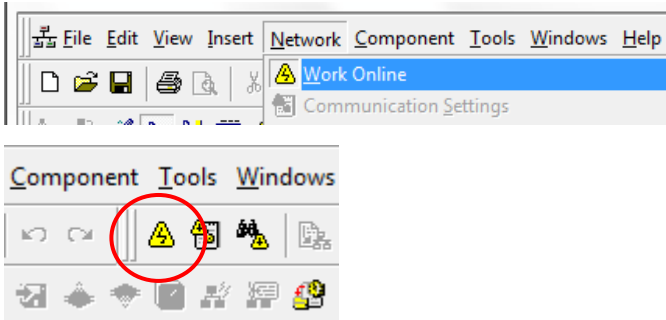

7.6.2. Checking Data That Are Sent and Received

Confirm that the correct data are sent and received.

⚠ WARNING

Always confirm safety at the destination node before you transfer a user program, configuration data, setup data, device variables, or values in memory used for CJ-series Units from the Sysmac Studio.

The devices or machines may perform unexpected operation regardless of the operating mode of the CPU Unit.



⚠ Caution

The Inverter will run if you proceed to this section. Confirm safety before operation. If you cannot confirm safety, do not proceed to this section after completing until Section 7.6.1.

If you proceed to this section, make sure to complete all the steps and place the Inverter in the safe state.



- 1 Select **Watch Tab Page** from the View Menu.

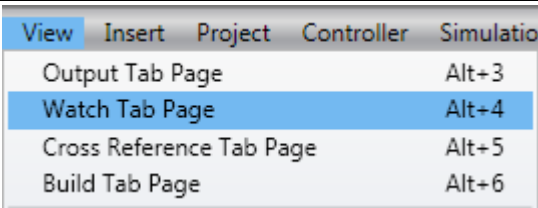

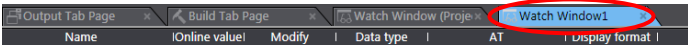
- 2 The Watch Tab Page 1 is displayed in the lower section of the Edit Pane.

- 3 The following names are entered in the Watch Tab Page for monitoring.

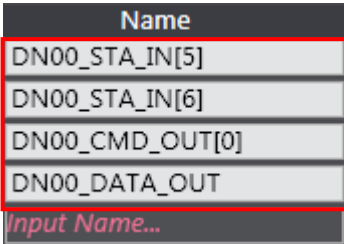
DN00_STA_IN[5]
 DN00_STA_IN[6]
 DN00_CMD_OUT[0]
 DN00_DATA_OUT

- 4 Set the display format as follows:

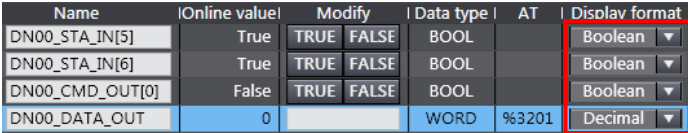
DN00_STA_IN[5]: [Boolean]
 DN00_STA_IN[6]: [Boolean]
 DN00_CMD_OUT[0]: [Boolean]
 DN00_DATA_OUT: [Decimal]



Name	Online value	Modify	Data type	AT	Display format
DN00_STA_IN[5]	True	TRUE FALSE	BOOL		Boolean
DN00_STA_IN[6]	True	TRUE FALSE	BOOL		Boolean
DN00_CMD_OUT[0]	False	TRUE FALSE	BOOL		Boolean
DN00_DATA_OUT	0		WORD	%3201	Decimal

5 Confirm that the online values of *DN00_STA_IN[5]* and *DN00_STA_IN[6]* are True.

*DN00_STA_IN[5]: CFN
0: Follow the setting of parameter A002.
1: DeviceNet reference

*DN00_STA_IN[6]: RFN
0: Follow the setting of parameter A001.
1: DeviceNet reference

Name	Online value	Modify	Data type
DN00_STA_IN[5]	True	TRUE FALSE	BOOL
DN00_STA_IN[6]	True	TRUE FALSE	BOOL
DN00_CMD_OUT[0]	False	TRUE FALSE	BOOL
DN00_DATA_OUT	0		WORD

6 Enter 100 in the Modify Column of *DN00_DATA_OUT*.

*[DN00_DATA_OUT: Rotation Speed Reference]
The unit of the rotation speed is 0.01 Hz.

After entering values, press the **Enter** key on the keyboard. The online value is changed to 100.

Name	Online value	Modify	Data type
DN00_STA_IN[5]	True	TRUE FALSE	BOOL
DN00_STA_IN[6]	True	TRUE FALSE	BOOL
DN00_CMD_OUT[0]	False	TRUE FALSE	BOOL
DN00_DATA_OUT	0	100	WORD

↓

Name	Online value	Modify	Data type	AT
DN00_STA_IN[5]	True	TRUE FALSE	BOOL	
DN00_STA_IN[6]	True	TRUE FALSE	BOOL	
DN00_CMD_OUT[0]	False	TRUE FALSE	BOOL	
DN00_DATA_OUT	100	100	WORD	%3201

7 Confirm that RUN LED indicator of the Inverter is not lit and *0.00* is shown on the data display (Output frequency setting).

OMRON
3G3RX INVERTER

● POWER
○ ALARM

○ RUN
○ PRG

0.00

● Hz
○ V } kW
○ A }
○ %

8 Click **True** in the Modify Column of *DN00_CMD_OUT[0]*.

*DN00_CMD_OUT[0]: FW
0: Stop/1: Forward

The online value changes to True.

Name	Online value	Modify	Data type	AT
DN00_STA_IN[5]	True	TRUE FALSE	BOOL	
DN00_STA_IN[6]	True	TRUE FALSE	BOOL	
DN00_CMD_OUT[0]	False	TRUE FALSE	BOOL	
DN00_DATA_OUT	100	100	WORD	%3201

↓

Name	Online value	Modify	Data type
DN00_STA_IN[5]	True	TRUE FALSE	BOOL
DN00_STA_IN[6]	True	TRUE FALSE	BOOL
DN00_CMD_OUT[0]	True	TRUE FALSE	BOOL
DN00_DATA_OUT	100	100	WORD

9 Confirm that RUN LED indicator of the Inverter is lit and *1.00* is shown on the data display (Output frequency).

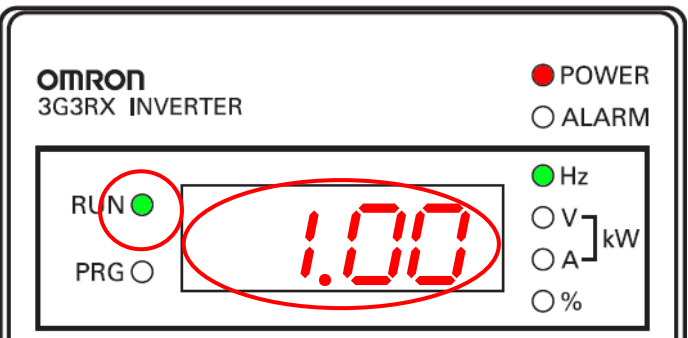

10 Click **FALSE** in the Modify Column of *DN00_CMD_OUT[0]*.
The online value changes to False.

Name	Online value	Modify	Data type
DN00_STA_IN[5]	True	TRUE FALSE	BOOL
DN00_STA_IN[6]	True	TRUE FALSE	BOOL
DN00_CMD_OUT[0]	False	TRUE FALSE	BOOL
DN00_DATA_OUT	100	100	WORD

11 Confirm that *0.00* is shown on the data display (Output frequency) on the front of the Inverter again and that the RUN LED indicator is not lit.

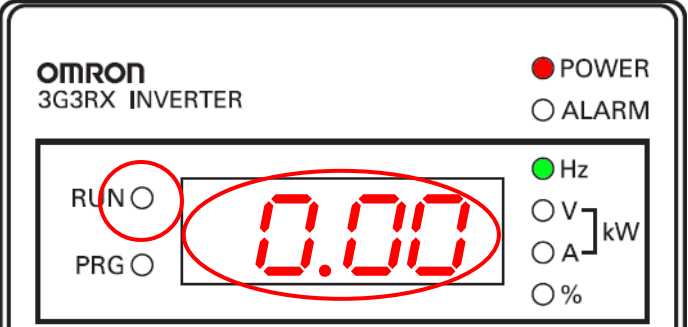

8. Initialization Method

This document explains the setting procedure from the factory default setting.

Some settings may not be applicable as described in this document unless you use the devices with the factory default setting.

8.1. Controller

To initialize the Controller, it is necessary to initialize the CPU Unit and DeviceNet Unit. Change to the PROGRAM mode before initialization.

8.1.1. DeviceNet Unit

To initialize the settings of the DeviceNet Unit, select **Edit Special Unit Settings** of CJ1W-DRM21 in CPU/Expansion Racks from the Sysmac Studio.

Select ***Clears the scan list*** from the Scan List Clear Switch.

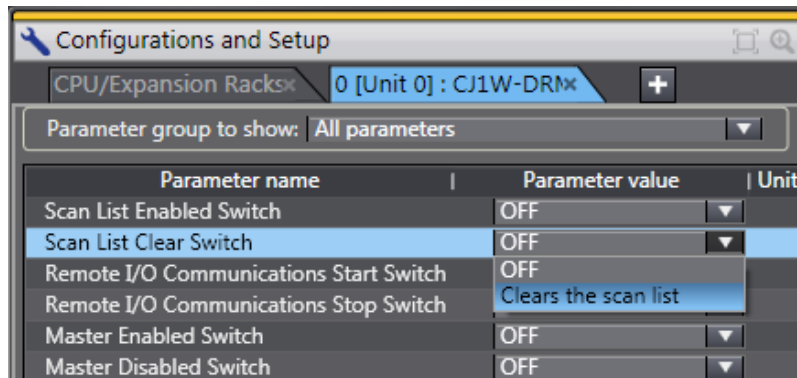

Click the **Apply** Button and the **Transfer to Controller** Button.

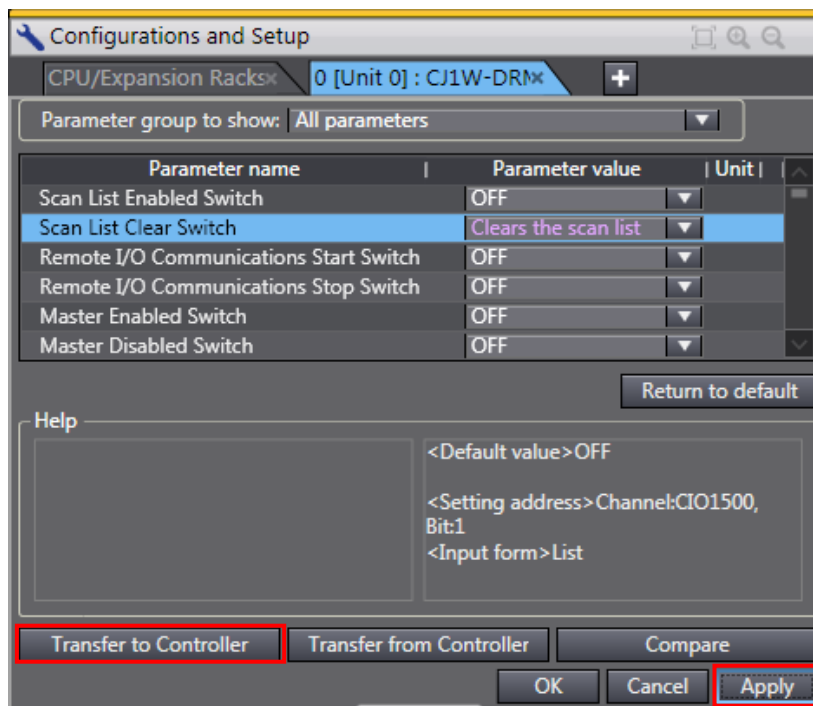

8.1.2. CPU Unit

To initialize the settings of the Controller, select **Clear All Memory** from the Controller Menu of the Sysmac Studio.

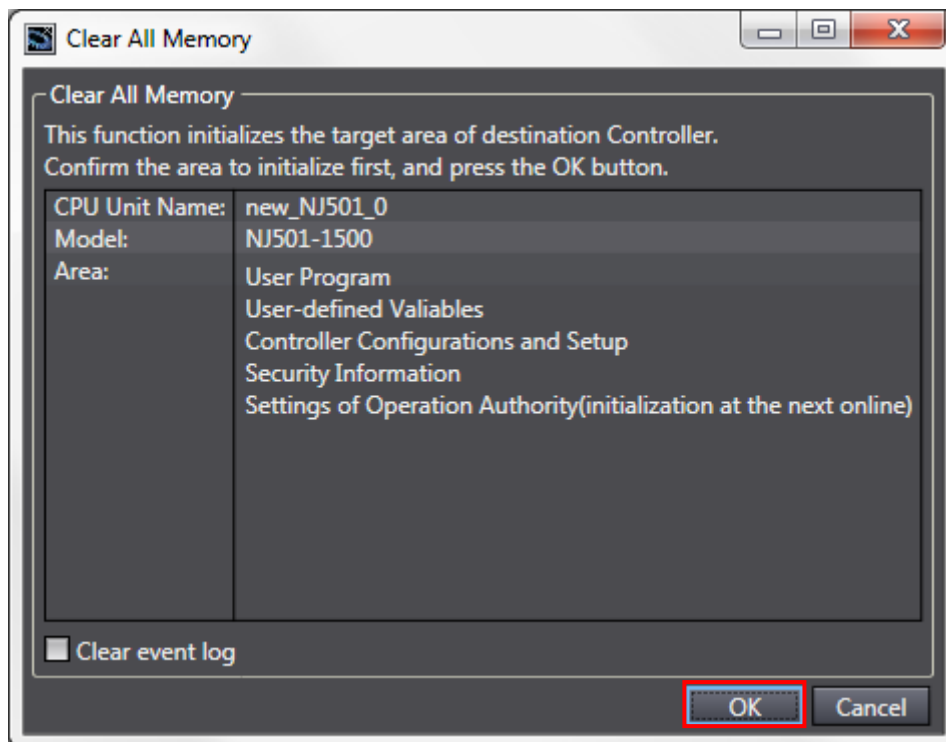

8.2. Inverter

For the initialization of the Inverter, refer to *Initialization Setting of 5-1-2 Parameter Initialization* in the *RX Series Type V1 High-function General-purpose Inverter User's Manual* (Cat. No. I578).

9. Appendix 1 Details on Remote I/O Communication Settings

This section explains the details on the settings necessary to perform remote I/O communications of DeviceNet that is set in this document.

9.1. Global Variable Table

The Controller accesses the remote I/O communications data as global variables. The settings of the global variables are shown below. Use the Sysmac Studio to register a global variable table.

Name	Data type	AT	Destination device allocation
DN00_CMD_OUT	BOOL[16]	%3200	Command
DN00_DATA_OUT	WORD	%3201	Rotation Speed Reference
DN00_STA_IN	BOOL[16]	%3300	Status information
DN00_DATA_IN	WORD	%3301	Rotation Speed Monitor



Additional Information

Set the AT to the values in memory used for CJ-series Units, which were allocated to the slaves using the CX-Integrator. With the Sysmac Studio, add the prefix "%" to each address to indicate the memory used for CJ-series Units. To allocate a bit address, set the data type to BOOL and set the AT to %3200.00 as shown below.

Name	Data type	AT	Destination device allocation
DN00_OUT_Bit00	BOOL	%3200.00	Bit 00 Output
:			
DN00_OUT_Bit15	BOOL	%3200.15	Bit 15 Output
DN00_IN_Bit00	BOOL	%3300.00	Bit 00 Input
:			
DN00_IN_Bit15	BOOL	%3300.15	Bit 15 Input

Do not specify the same area for the bit and word addresses as shown below.

Name	Data type	AT	Destination device allocation
DN00_OUT_Bit00	BOOL	%3200.00	Bit 00 Output
:			
DN00_OUT_Bit15	BOOL	%3200.15	Bit 15 Output
DN00_OUT	WORD	%3200	Bits 00 to 15 Output (2 bytes)



Additional Information

With the Sysmac Studio, the data type is expressed as ARRAY[0..2] OF WORD when an array is specified for a data type. However, a data type of an array is simplified in this document. (e.g. WORD[3]).

You can set either of the following to specify an array for a data type with the Sysmac Studio.

- ARRAY[0..2] OF WORD
- WORD[3]

In the example above, 3 WORD array elements are secured.

10. Appendix 2 Setting Procedure without the Configuration Files

This section describes the procedure for setting up the Controller using the software without using the configuration files (Procedure for setting the parameters from the beginning).

You can also refer to this section when you change the parameters of the configuration files.

10.1. Overview of Setting Procedure without the Configuration Files

The following figure shows the relationship of processes to perform remote I/O communications using the "procedure for setting parameters from the beginning".

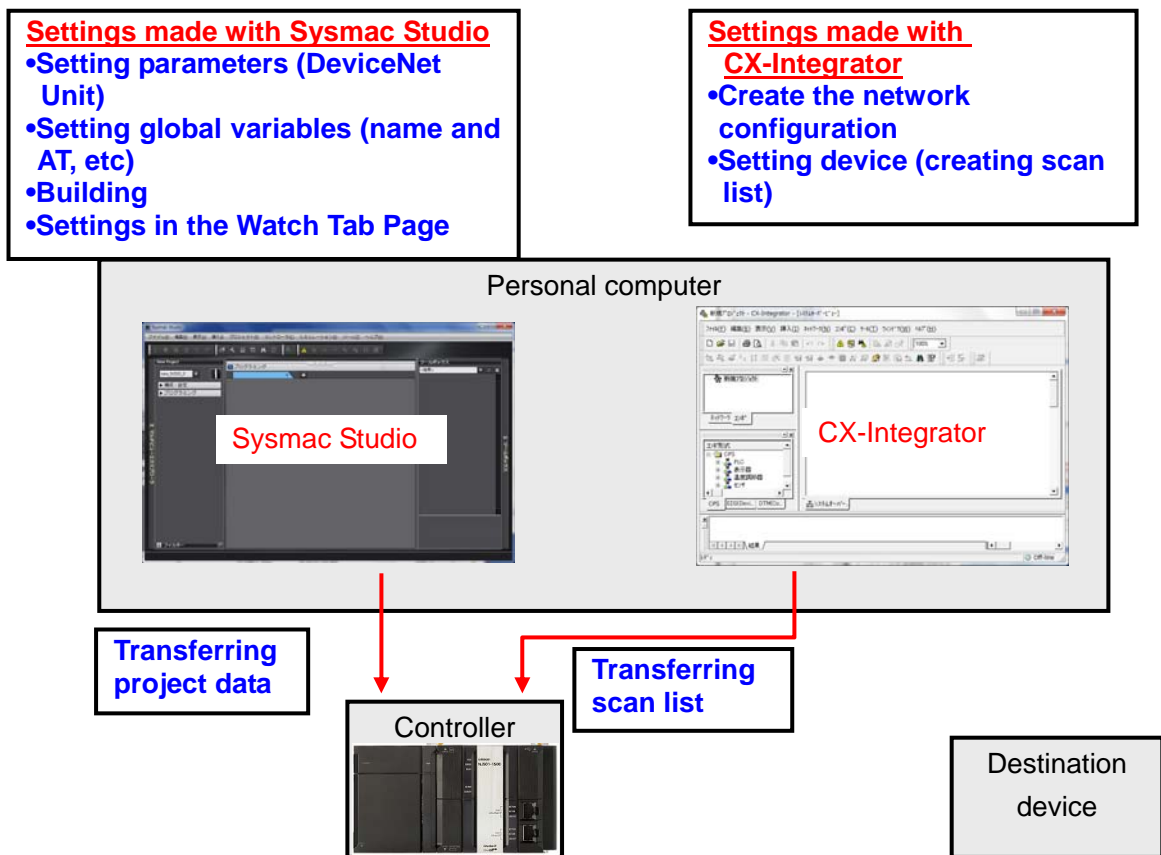

10.2. Work Flow of the "Procedure for Setting Parameters from the Beginning"

The following is the procedure for making connection settings for remote I/O communications of the DeviceNet using the "procedure for setting parameters from the beginning".

This section describes the detailed procedures for "10.3 Setting up the Controller without the Configuration Files" and "10.4 Setting up the Network by CX-Integrator" (in red frames below) to make settings with software without using "configuration files".

For details on the procedures for 7.3 Setting the Inverter, 7.4.1 Hardware Setting for the DeviceNet Master Unit, and 7.6 Checking the Connection Status, refer to *Section 7* because they are the same as the "procedure for using the configuration files".

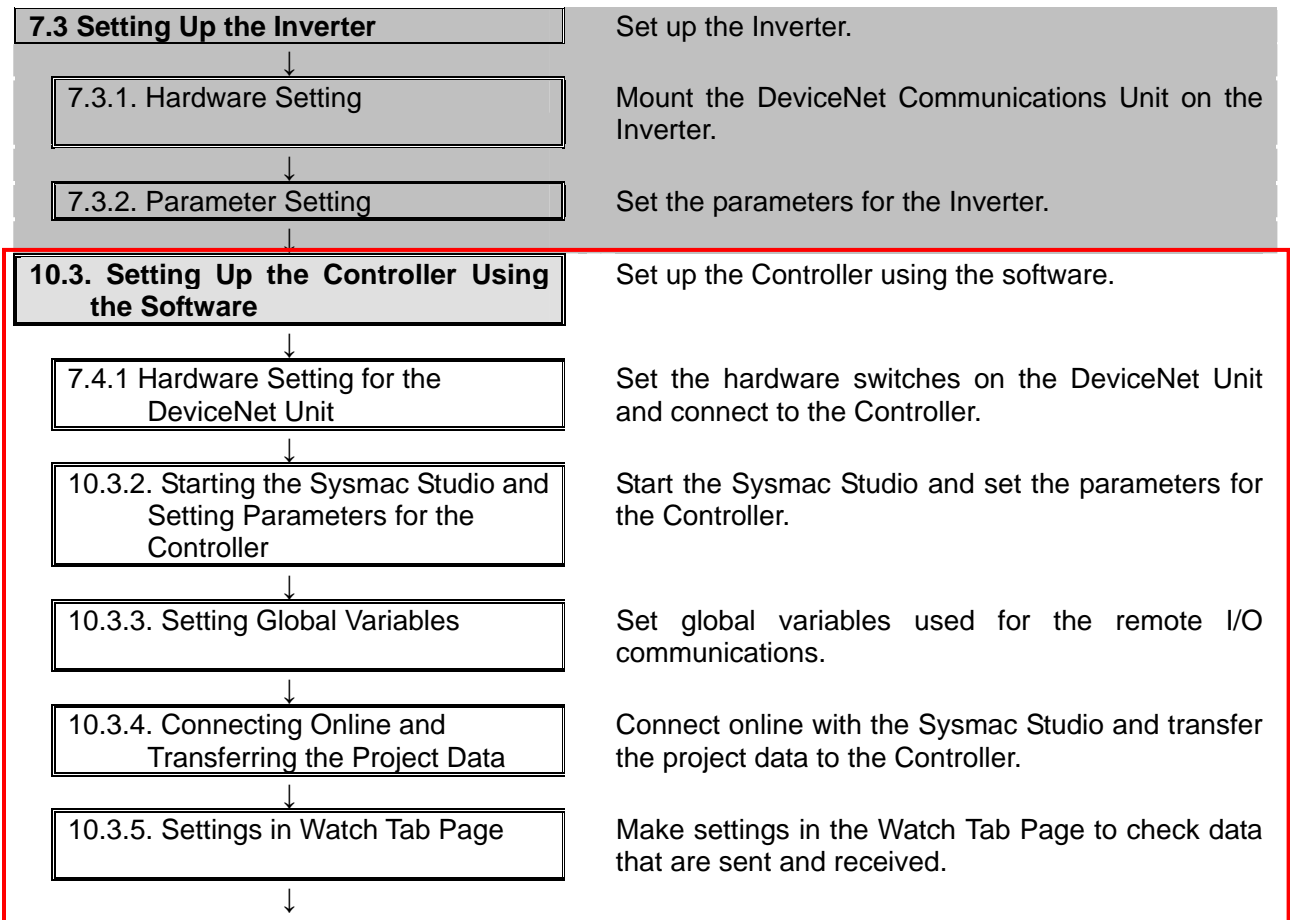

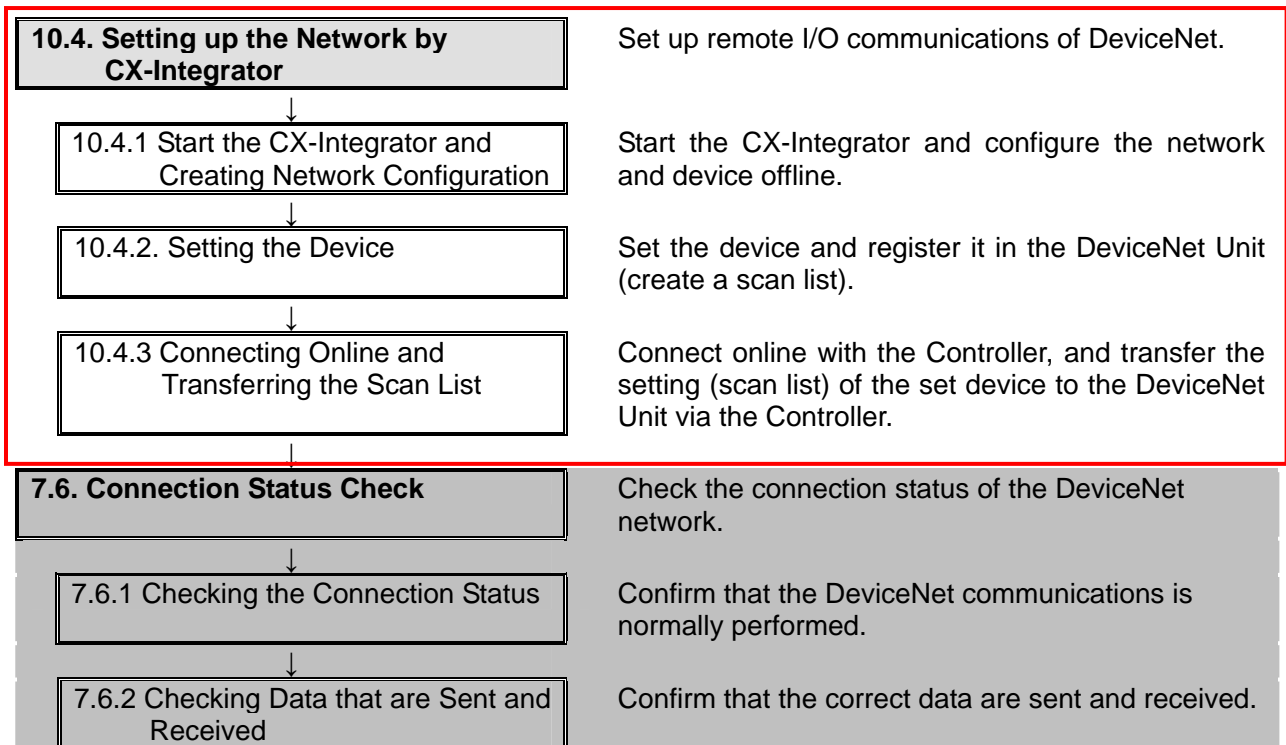

10.3. Setting Up the Controller without the Configuration Files

Set up the Controller using the software.

10.3.2. Starting the Sysmac Studio and Setting the Parameters for the Controller

Start the Sysmac Studio and set the parameters for the Controller.

- 1 Start the Sysmac Studio.
Click the **New Project** Button.

*If a dialog box is displayed at start confirming the access right, select an option to start.



- 2 The Project Properties Dialog Box is displayed.

*In this document, New Project is set as the project name.

Confirm the Category and Device you use are set in the Select Device Field.

Select version 1.03 from the pull-down list of Version.

*Although 1.03 is selected in this document, select a version you actually use.

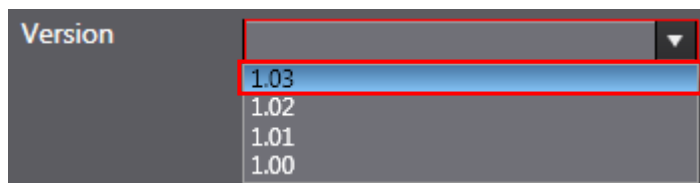
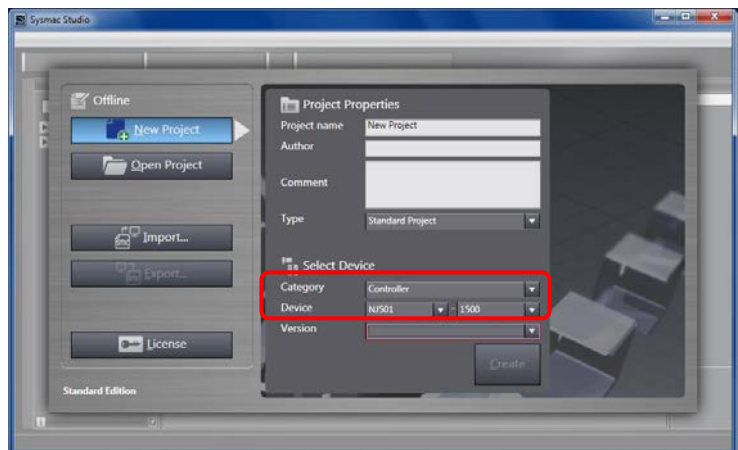

- 3 Click the **Create** Button.

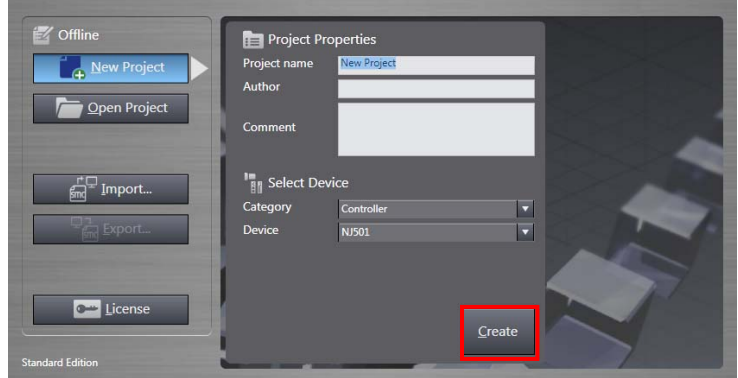

- 4 The New Project is displayed. The left pane is called Multiview Explorer, the right pane is called Toolbox and the middle pane is called Edit Pane.

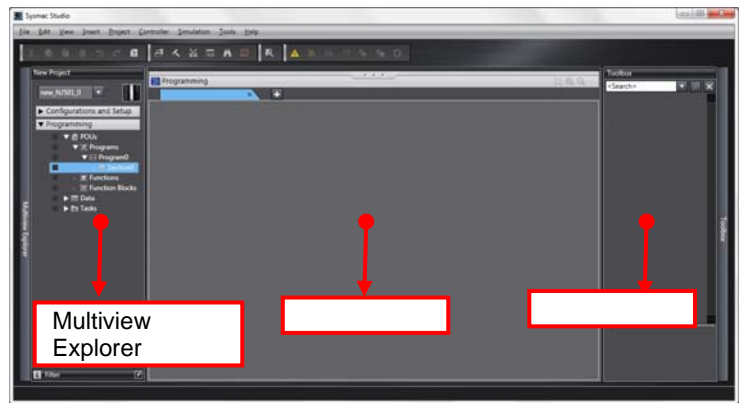

- 5 Double-click **CPU/Expansion Racks** under **Configurations and Setup** in the Multiview Explorer. The CPU/Expansion Racks Tab is displayed on the Edit Pane.

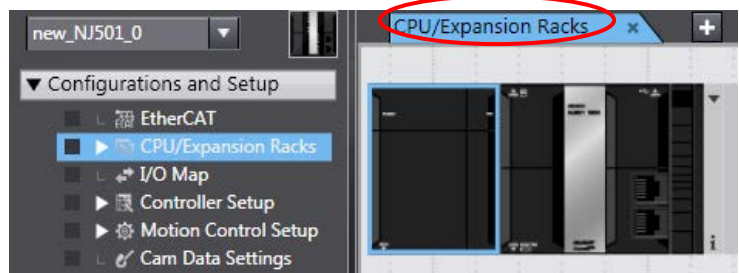

- 6 Select **Communications** under Category in the Toolbox.

Select **CJ1W-DRM21**.

Right-click the *CJ1W-DRM21* to display a menu.

Select **Insert** from the menu.

CJ1W-DRM21 is displayed on the CPU/Expansion Racks as shown in the figure on the right.

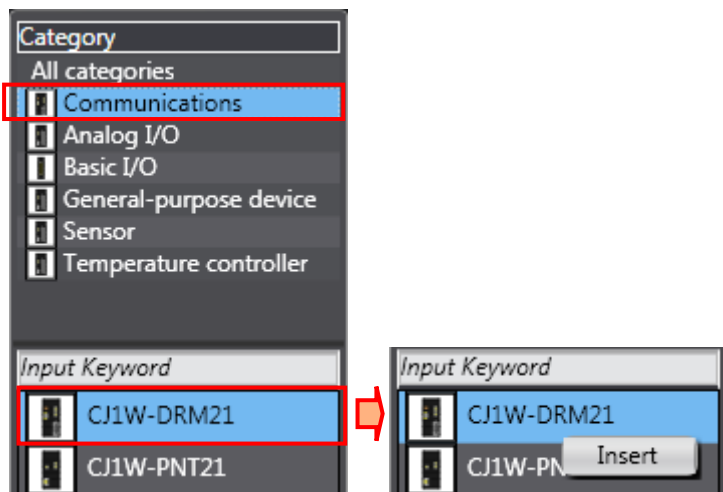

7 Enter 0 in the Unit No. Field.

Item name	Value
Device name	J01
Model name	CJ1W-DRM21
Product name	DeviceNet Master Unit
Specifications	Master/slave, 32000 poi...
Rack No.	0
Slot No.	0
Unit No.	0
Special Unit Settings	Settings Edit Special Unit Settings

10.3.3. Setting the Global Variables

Set global variables used for the remote I/O communications.

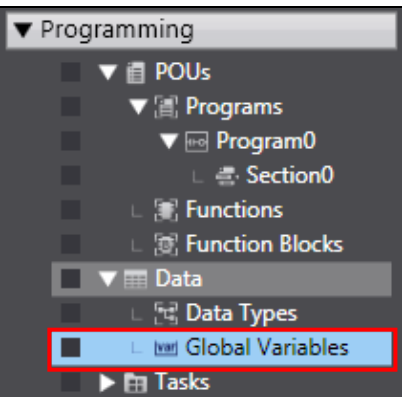
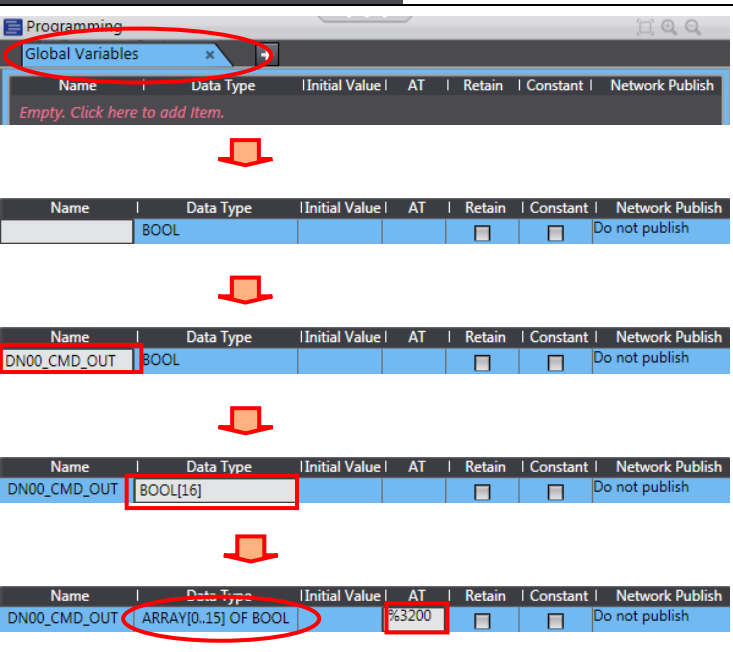
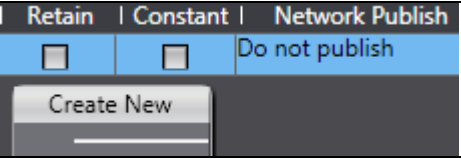
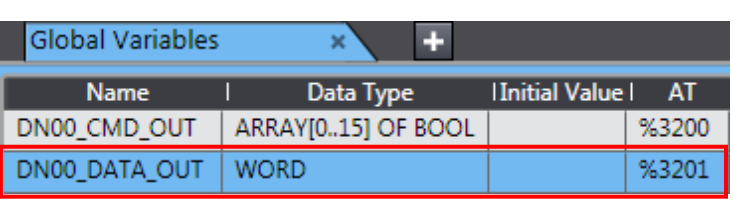
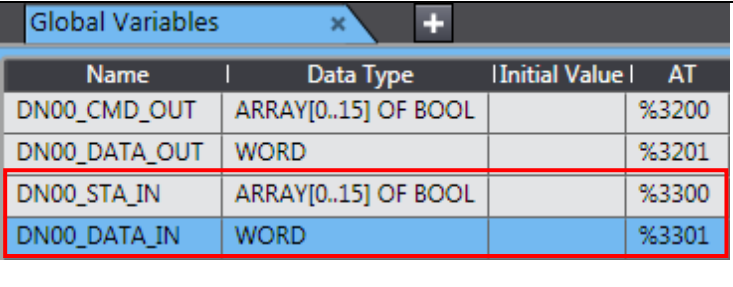
<p>1</p>	<p>Double-click Global Variables under Programming - Data in the Multiview Explorer.</p>																																																									
<p>2</p>	<p>The Global Variables Tab Page is displayed in the Edit Pane. Click a column under Name to enter a new variable.</p> <p>Enter <i>DN00_CMD_OUT</i> in the Name Column.</p> <p>Enter <i>BOOL[16]</i> in the Data Type Column. *After entering, <i>ARRAY[0..15] OF BOOL</i> is displayed as shown on the right figure.</p> <p>Enter <i>%3200</i> in the AT Column.</p>	 <table border="1" data-bbox="710 884 1447 929"> <thead> <tr> <th>Name</th> <th>Data Type</th> <th>Initial Value</th> <th>AT</th> <th>Retain</th> <th>Constant</th> <th>Network Publish</th> </tr> </thead> <tbody> <tr> <td></td> <td>BOOL</td> <td></td> <td></td> <td><input type="checkbox"/></td> <td><input type="checkbox"/></td> <td>Do not publish</td> </tr> </tbody> </table> <table border="1" data-bbox="710 1019 1447 1064"> <thead> <tr> <th>Name</th> <th>Data Type</th> <th>Initial Value</th> <th>AT</th> <th>Retain</th> <th>Constant</th> <th>Network Publish</th> </tr> </thead> <tbody> <tr> <td>DN00_CMD_OUT</td> <td>BOOL</td> <td></td> <td></td> <td><input type="checkbox"/></td> <td><input type="checkbox"/></td> <td>Do not publish</td> </tr> </tbody> </table> <table border="1" data-bbox="710 1153 1447 1198"> <thead> <tr> <th>Name</th> <th>Data Type</th> <th>Initial Value</th> <th>AT</th> <th>Retain</th> <th>Constant</th> <th>Network Publish</th> </tr> </thead> <tbody> <tr> <td>DN00_CMD_OUT</td> <td>BOOL[16]</td> <td></td> <td></td> <td><input type="checkbox"/></td> <td><input type="checkbox"/></td> <td>Do not publish</td> </tr> </tbody> </table> <table border="1" data-bbox="710 1288 1447 1332"> <thead> <tr> <th>Name</th> <th>Data Type</th> <th>Initial Value</th> <th>AT</th> <th>Retain</th> <th>Constant</th> <th>Network Publish</th> </tr> </thead> <tbody> <tr> <td>DN00_CMD_OUT</td> <td>ARRAY[0..15] OF BOOL</td> <td></td> <td>%3200</td> <td><input type="checkbox"/></td> <td><input type="checkbox"/></td> <td>Do not publish</td> </tr> </tbody> </table>	Name	Data Type	Initial Value	AT	Retain	Constant	Network Publish		BOOL			<input type="checkbox"/>	<input type="checkbox"/>	Do not publish	Name	Data Type	Initial Value	AT	Retain	Constant	Network Publish	DN00_CMD_OUT	BOOL			<input type="checkbox"/>	<input type="checkbox"/>	Do not publish	Name	Data Type	Initial Value	AT	Retain	Constant	Network Publish	DN00_CMD_OUT	BOOL[16]			<input type="checkbox"/>	<input type="checkbox"/>	Do not publish	Name	Data Type	Initial Value	AT	Retain	Constant	Network Publish	DN00_CMD_OUT	ARRAY[0..15] OF BOOL		%3200	<input type="checkbox"/>	<input type="checkbox"/>	Do not publish
Name	Data Type	Initial Value	AT	Retain	Constant	Network Publish																																																				
	BOOL			<input type="checkbox"/>	<input type="checkbox"/>	Do not publish																																																				
Name	Data Type	Initial Value	AT	Retain	Constant	Network Publish																																																				
DN00_CMD_OUT	BOOL			<input type="checkbox"/>	<input type="checkbox"/>	Do not publish																																																				
Name	Data Type	Initial Value	AT	Retain	Constant	Network Publish																																																				
DN00_CMD_OUT	BOOL[16]			<input type="checkbox"/>	<input type="checkbox"/>	Do not publish																																																				
Name	Data Type	Initial Value	AT	Retain	Constant	Network Publish																																																				
DN00_CMD_OUT	ARRAY[0..15] OF BOOL		%3200	<input type="checkbox"/>	<input type="checkbox"/>	Do not publish																																																				
<p>3</p>	<p>After entering values, right-click and select Create New from the menu.</p>																																																									
<p>4</p>	<p>Enter the following data in the new columns in the same way as step 2.</p> <ul style="list-style-type: none"> •Name: <i>DN00_DATA_OUT</i> Data type: <i>WORD</i> AT: <i>%3201</i> 	 <table border="1" data-bbox="710 1518 1447 1697"> <thead> <tr> <th>Name</th> <th>Data Type</th> <th>Initial Value</th> <th>AT</th> </tr> </thead> <tbody> <tr> <td>DN00_CMD_OUT</td> <td>ARRAY[0..15] OF BOOL</td> <td></td> <td>%3200</td> </tr> <tr> <td>DN00_DATA_OUT</td> <td>WORD</td> <td></td> <td>%3201</td> </tr> </tbody> </table>	Name	Data Type	Initial Value	AT	DN00_CMD_OUT	ARRAY[0..15] OF BOOL		%3200	DN00_DATA_OUT	WORD		%3201																																												
Name	Data Type	Initial Value	AT																																																							
DN00_CMD_OUT	ARRAY[0..15] OF BOOL		%3200																																																							
DN00_DATA_OUT	WORD		%3201																																																							
<p>5</p>	<p>Enter the following data in the new columns in the same way as steps 2 and 3.</p> <ul style="list-style-type: none"> •Name: <i>DN00_STA_IN</i> Data type: <i>BOOL[16]</i> AT: <i>%3300</i> •Name: <i>DN00_DATA_IN</i> Data type: <i>WORD</i> AT: <i>%3301</i> 	 <table border="1" data-bbox="710 1731 1447 1966"> <thead> <tr> <th>Name</th> <th>Data Type</th> <th>Initial Value</th> <th>AT</th> </tr> </thead> <tbody> <tr> <td>DN00_CMD_OUT</td> <td>ARRAY[0..15] OF BOOL</td> <td></td> <td>%3200</td> </tr> <tr> <td>DN00_DATA_OUT</td> <td>WORD</td> <td></td> <td>%3201</td> </tr> <tr> <td>DN00_STA_IN</td> <td>ARRAY[0..15] OF BOOL</td> <td></td> <td>%3300</td> </tr> <tr> <td>DN00_DATA_IN</td> <td>WORD</td> <td></td> <td>%3301</td> </tr> </tbody> </table>	Name	Data Type	Initial Value	AT	DN00_CMD_OUT	ARRAY[0..15] OF BOOL		%3200	DN00_DATA_OUT	WORD		%3201	DN00_STA_IN	ARRAY[0..15] OF BOOL		%3300	DN00_DATA_IN	WORD		%3301																																				
Name	Data Type	Initial Value	AT																																																							
DN00_CMD_OUT	ARRAY[0..15] OF BOOL		%3200																																																							
DN00_DATA_OUT	WORD		%3201																																																							
DN00_STA_IN	ARRAY[0..15] OF BOOL		%3300																																																							
DN00_DATA_IN	WORD		%3301																																																							

10.3.4. Connecting Online and Transferring the Project Data

Connect online with the Sysmac Studio and transfer the project data to the Controller. After transfer, reset the Controller.

⚠ WARNING

Always confirm safety at the destination node before you transfer a user program, configuration data, setup data, device variables, or values in memory used for CJ-series Units from the Sysmac Studio.

The devices or machines may perform unexpected operation regardless of the operating mode of the CPU Unit.





⚠ Caution

Always confirm safety before you reset the Controller or any components.

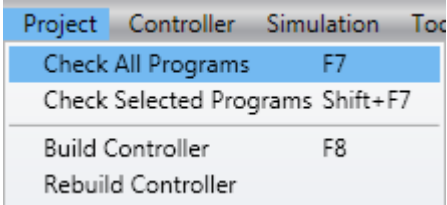
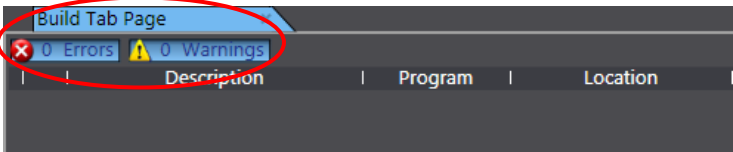
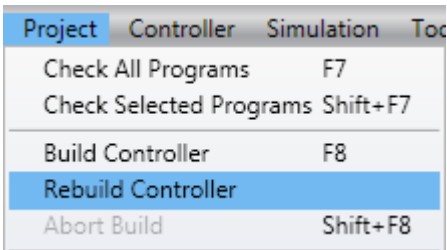
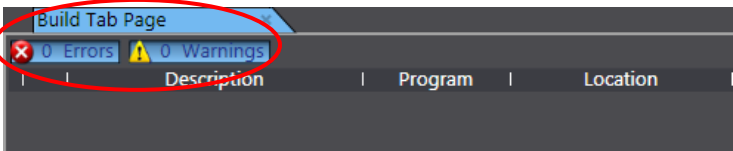

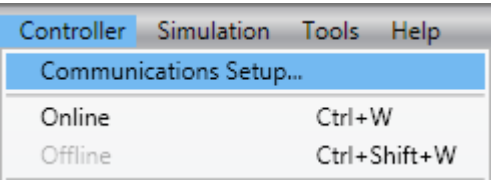
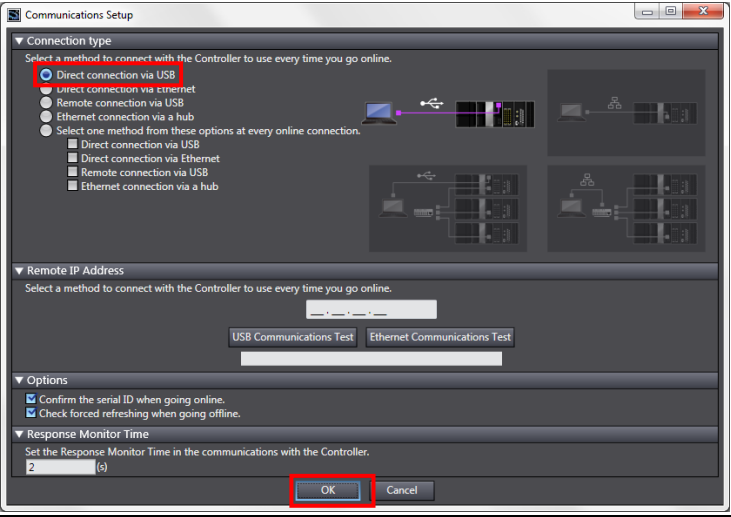
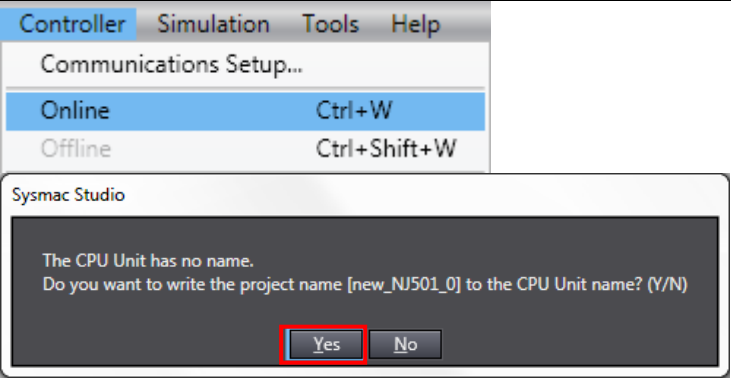
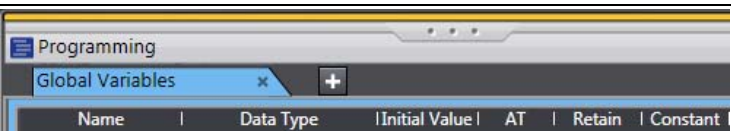
- | | | |
|---|---|--|
| 1 | Select Check All Programs from the Project Menu. |  |
| 2 | The Build Tab Page is displayed in the Edit Pane. Confirm that "0 Errors" and "0 Warnings" are displayed. |  |
| 3 | Select Rebuild Controller from the Project Menu. |  |
| 4 | Confirm that "0 Errors" and "0 Warnings" are displayed in the Build Tab Page. |  |

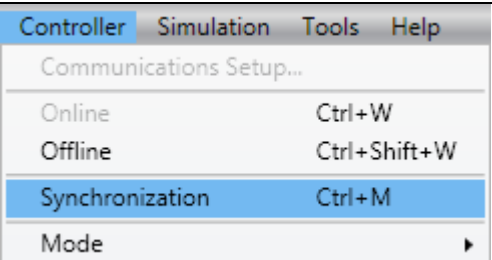
- 5 Select **Communications Setup** from the Controller Menu.
- 
- 6 The Communications Setup Dialog Box is displayed. Select the *Direct connection via USB* Option in the Connection Type Field.
- Click the **OK** Button.
- 
- 7 Select **Online** from the Controller Menu. A confirmation dialog is displayed. Click the **Yes** Button.
- *The displayed dialog depends on the status of the Controller used. Click the **Yes** Button to proceed with the processing.
- 
- 8 When an online connection is established, a yellow bar is displayed on the top of the Edit Pane.
- 
-  **Additional Information**
- For details on the online connections to a Controller, refer to *Section 5 Going Online with a Controller* in the *Sysmac Studio Version 1 Operation Manual* (Cat. No. W504).
- 9 Select **Synchronization** from the Controller Menu.
- 

10 The Synchronization Dialog Box is displayed. Confirm that the data to transfer (NJ501 in the right figure) is selected, and click the **Transfer to Controller** Button.

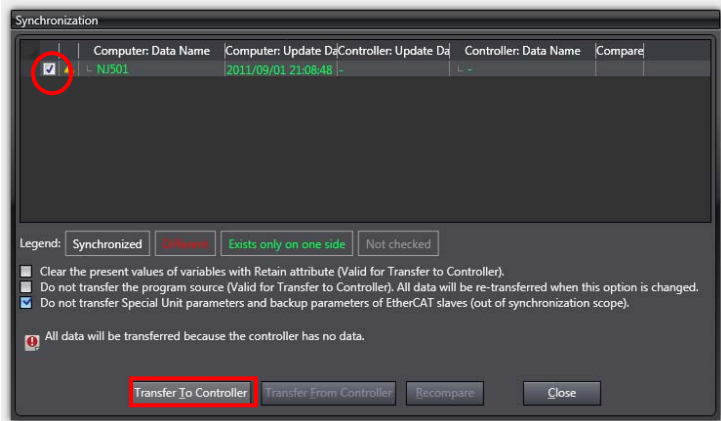

11 A confirmation dialog is displayed. Click the **Yes** Button.

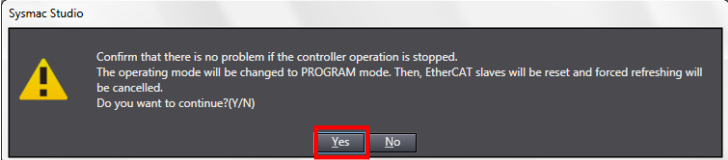

A screen stating "Synchronizing" is displayed.

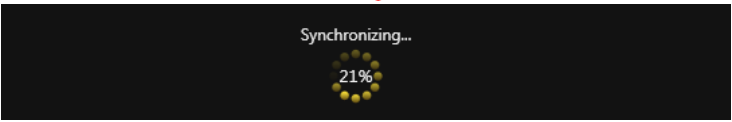

A confirmation dialog box is displayed. Click the **No** Button.

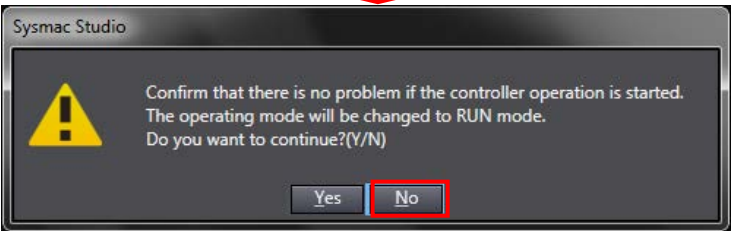

12 Confirm that the synchronized data is displayed with the color specified by "Synchronized" color, and that a message is displayed stating "The synchronization process successfully finished".

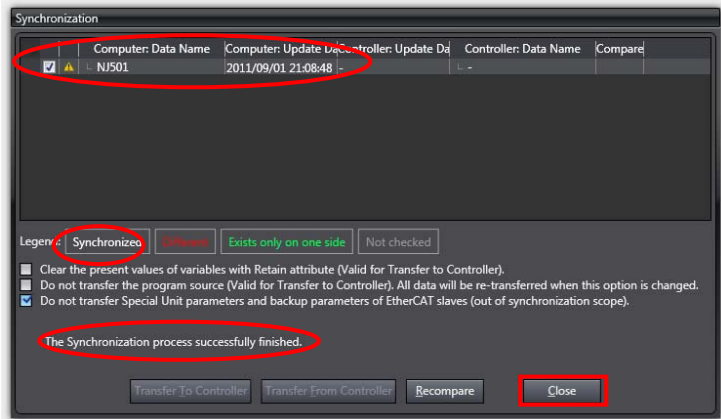

If there is no problem, click the **Close** Button.

*If the synchronization fails, check the wiring and repeat the procedure described in this section.

13 Select **Reset Controller** from the Controller Menu.

*When Mode is set to RUN Mode, Reset Controller cannot be selected. In this case, select **Mode - PROGRAM Mode** from the Controller Menu to change to PROGRAM mode and perform the procedure in this step.

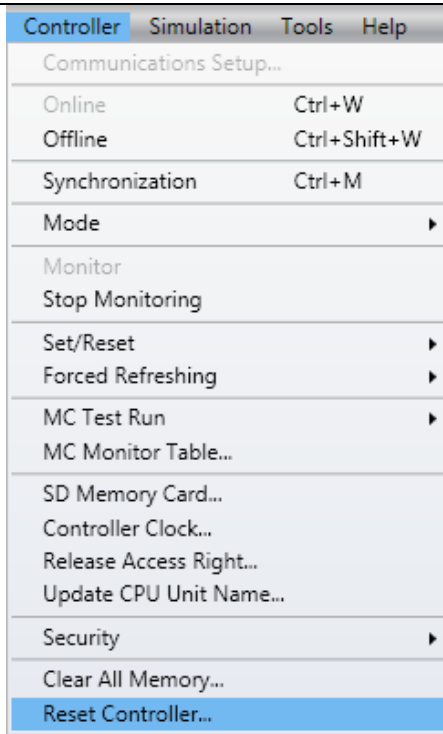

14 A confirmation dialog box is displayed. Click the **Yes** Button.

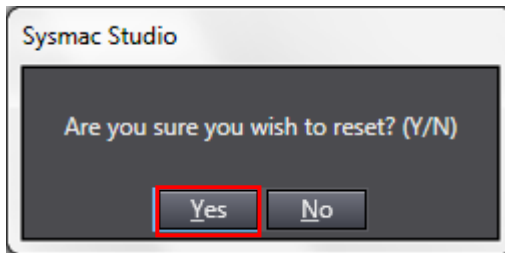
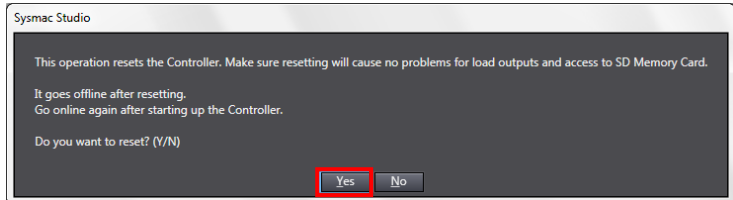

15 The controller is reset, and Sysmac Studio goes offline.

The yellow bar on the top of the Edit Pane disappears.

Use steps 7 to 9 to go online.

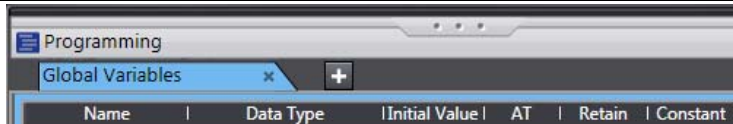

10.3.5. Settings in the Watch Tab Page

Make settings in the Watch Tab Page to check data that are sent and received.

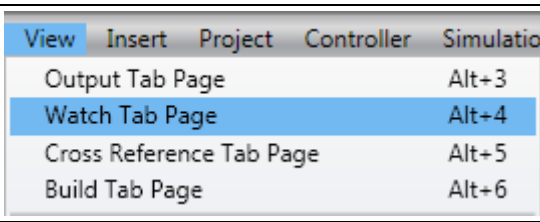
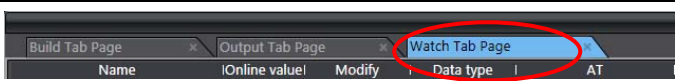
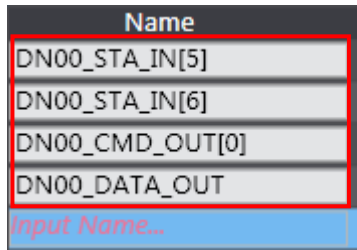
<p>1 Select Watch Tab Page from the View Menu.</p>	
<p>2 The Watch Tab Page 1 is displayed in the lower section of the Edit Pane.</p>	
<p>3 Enter the following names to monitor in the Name Column on the Watch Tab Page 1. To enter a new name, click a column stating Input Name.</p> <p>DN00_STA_IN[5] DN00_STA_IN[6] DN00_CMD_OUT[0] DN00_DATA_OUT</p> <p>*The settings are used in 7.6.2. Checking Data That Are Sent and Received.</p>	

10.4. Setting Up the Network by CX-Integrator

Set up remote I/O communications of the DeviceNet by CX-Integrator.

10.4.1. Starting CX-Integrator and Configuring the Network

Start the CX-Integrator and configure the network and device offline.



Precautions for Correct Use

Please confirm that the DeviceNet cable is connected before proceeding to the following procedures.

If it is not connected, turn OFF the power to the devices, and then connect the DeviceNet cable.

<p>1 Start the CX-Integrator.</p> <p>*If the Component List Window is not displayed, select Windows - Component List Window from the View Menu.</p> <p>Component List Window</p>																	
<p>2 Select Network from the Insert Menu of the CX-Integrator.</p>																	
<p>3 Select DeviceNet and click the Next Button.</p>	<table border="1" style="margin-left: auto; margin-right: auto;"> <thead> <tr> <th>Name</th> <th>Description</th> </tr> </thead> <tbody> <tr> <td>CompoNet</td> <td>Fieldbus Network(CompoNet)</td> </tr> <tr> <td>CompoWayF</td> <td>Serial connection(for compor</td> </tr> <tr> <td>ControllerLink</td> <td>PLC level Network(CLK)</td> </tr> <tr style="background-color: #e0e0e0;"> <td>DeviceNet</td> <td>Fieldbus Network(DeviceNet)</td> </tr> <tr> <td>Ethernet</td> <td>Ethernet(FINS)</td> </tr> <tr> <td>NTLink</td> <td>Serial connection(for display:</td> </tr> <tr> <td>SysmacLink</td> <td>PLC level Network(SLK)</td> </tr> </tbody> </table>	Name	Description	CompoNet	Fieldbus Network(CompoNet)	CompoWayF	Serial connection(for compor	ControllerLink	PLC level Network(CLK)	DeviceNet	Fieldbus Network(DeviceNet)	Ethernet	Ethernet(FINS)	NTLink	Serial connection(for display:	SysmacLink	PLC level Network(SLK)
Name	Description																
CompoNet	Fieldbus Network(CompoNet)																
CompoWayF	Serial connection(for compor																
ControllerLink	PLC level Network(CLK)																
DeviceNet	Fieldbus Network(DeviceNet)																
Ethernet	Ethernet(FINS)																
NTLink	Serial connection(for display:																
SysmacLink	PLC level Network(SLK)																

- 4 Select the *Not Used* Check Box in the Network Address Field and click the **Finish** Button.

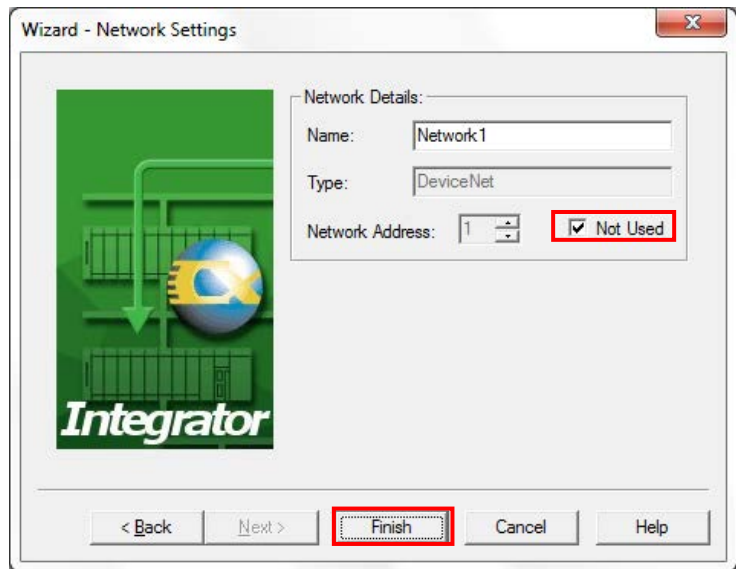

- 5 Register the Master Unit in the Network. Select **Component** from the Insert Menu.

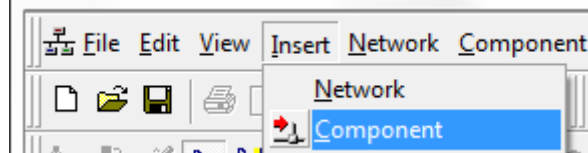

- 6 Select the Master Unit from the component list and click the **Finish** Button. Here, select **OMRON Corporation - Communications Adapter - CJ1W-DRM21**.

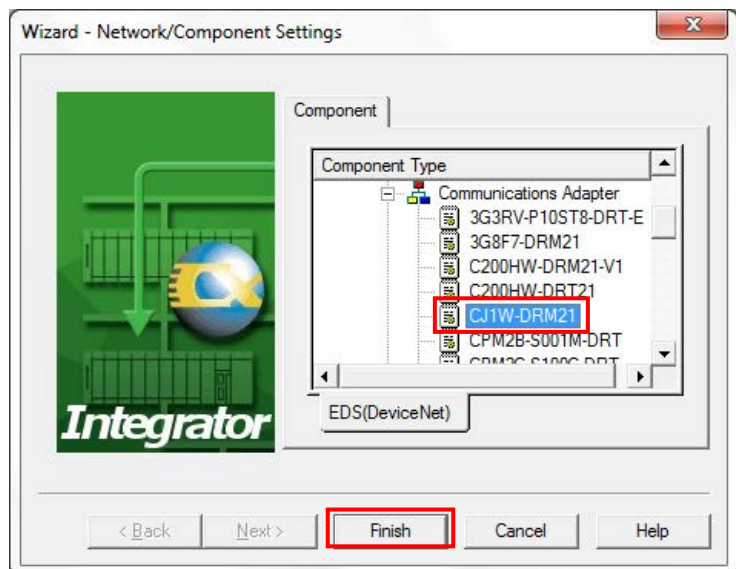

- 7 Enter the node address (63 is entered here) in the Node Address Setup Dialog Box, and click the **OK** Button.

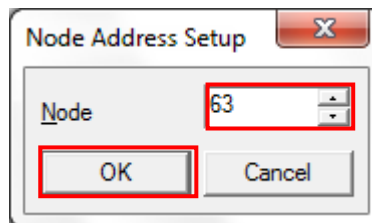

- 8 Confirm that the Master Unit is registered in the Network Configuration Window.

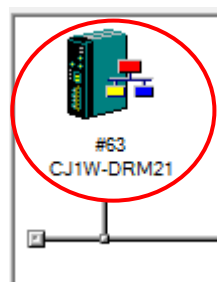

- 9 Register the Inverter (hereinafter referred to as the Slave Unit) in the network.
Select **Component** from the Insert Menu.

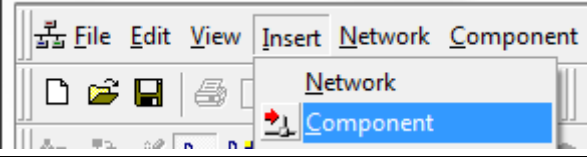
- 10 Select the Slave Unit to connect from the component list, and click the **Finish** Button.
Here, select 3G3AX-RX-DRT-A2055.

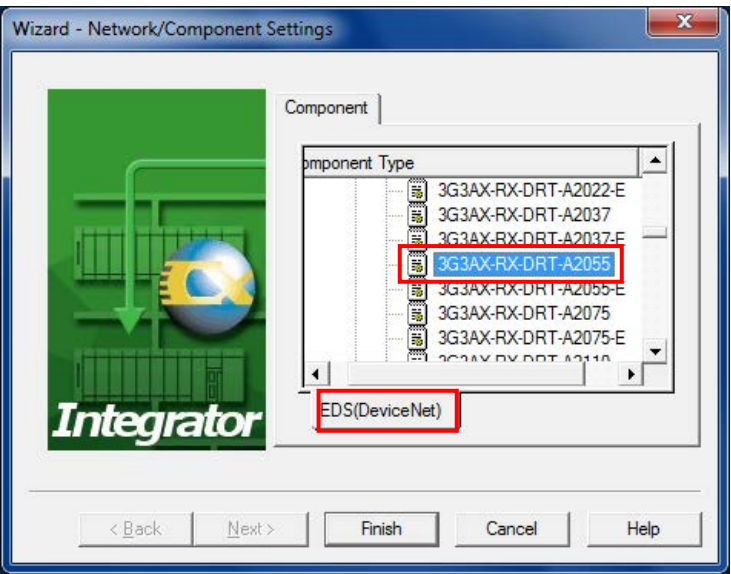

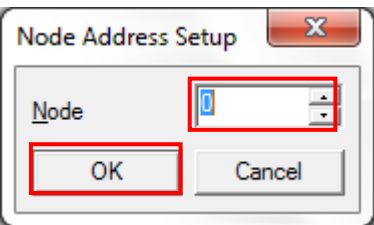
- 11 Enter the node address (0 is entered here) in the Node Address Setup Dialog Box, and click the **OK** Button.

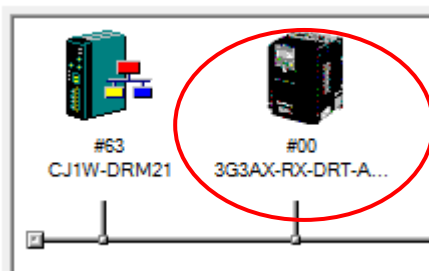
- 12 Confirm that the Slave Unit is registered in the Network Configuration Window.



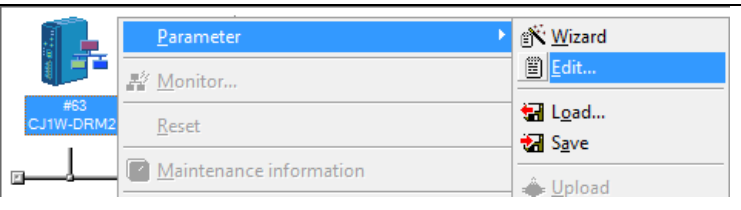
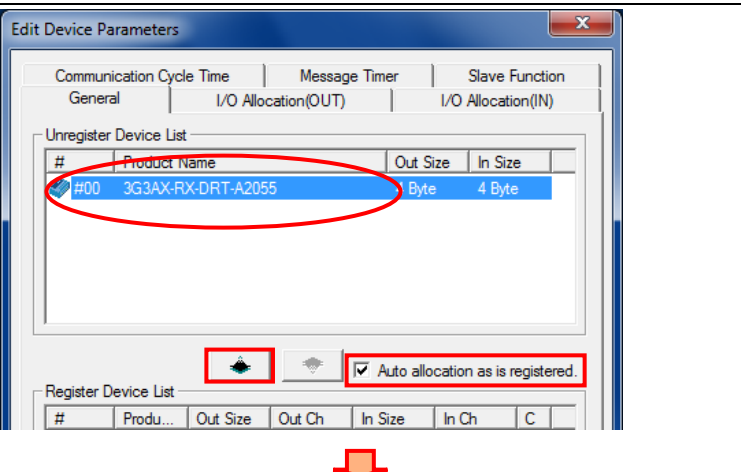
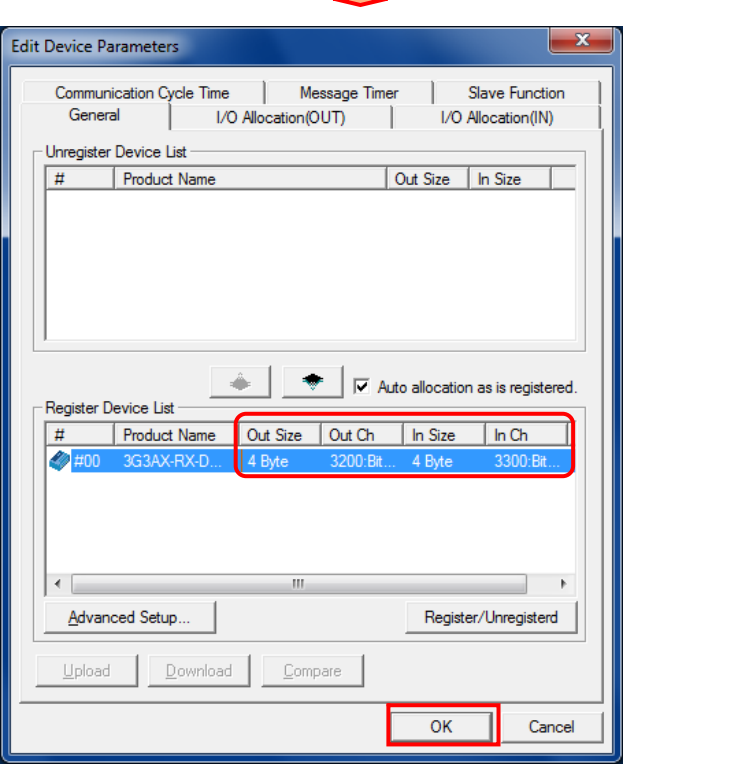
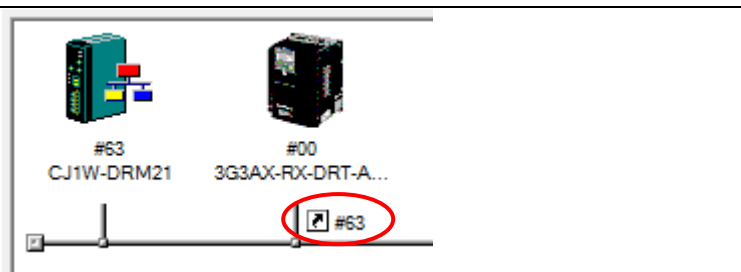

10.4.2. Setting the Device

Set the device and register it in the Master Unit (create a scan list).

<p>1 Right-click the master icon and select Parameter - Edit.</p>	
<p>2 The Edit Device Parameters Dialog Box is displayed. Slave Unit (#00) is displayed in the Unregister Device List.</p> <p>Select the <i>Auto allocation as is registered</i> Check Box. Click the ↓ button.</p> <p>Slave Unit (#00) is registered in the Unregister Device List.</p> <p>Confirm that the sizes and channels are set as follows, and click the OK Button. OUT Size: 4 Byte Out Ch: 3200:Bit00 In Size: 4 Byte In Ch: 3300:Bit00</p>	 
<p>3 Confirm that node address #63 is displayed under the slave unit icon on the Network Configuration Window.</p>	

10.4.3. Connecting Online and Transferring the Scan List

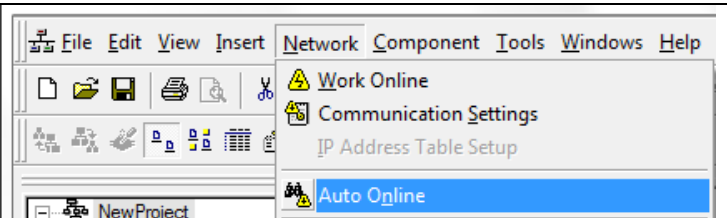
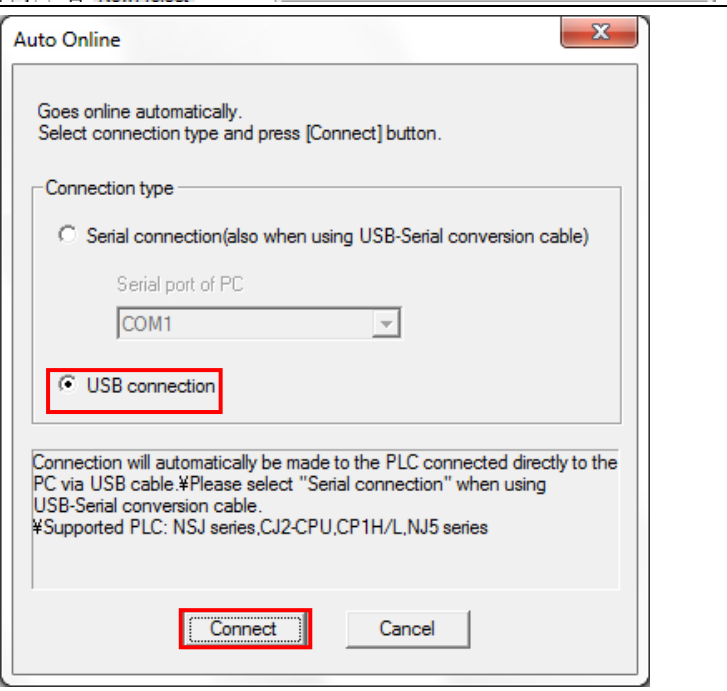
Connect online with the Controller, and transfer the setting (scan list) of the set device to the DeviceNet Unit via the Controller. When the transfer is completed, remote I/O communications start automatically.

<p>1 Select Auto Online from the Network Menu.</p>	
<p>2 The Auto Online Dialog Box is displayed. Select the USB connection Option in the Connection type Field, and click the Connect Button.</p> <p>A screen is displayed indicating the connection is being established.</p>	
<p>3 After an online connection is established, the background color of the Network Configuration Window changes as shown in the right figure.</p>	





Precautions for Correct Use

If an online connection cannot be made to the Controller, check the cable connection. Or, return to step 1 and check the settings such as a connection type and try again.

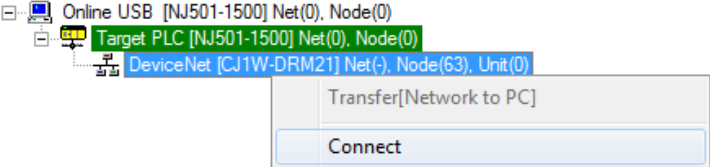
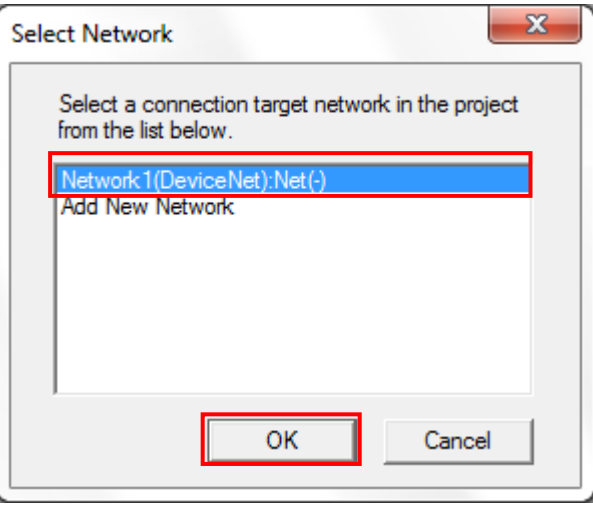

Additional Information

For details on the online connections to a Controller, refer to *Section 2 Basic Operations in the Communications of the CX-Integrator Ver.2.[J] Operation Manual* (Cat. No. W446).

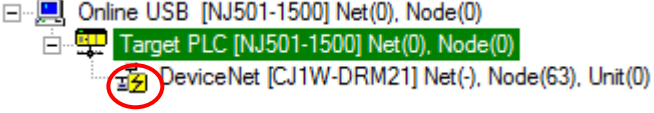
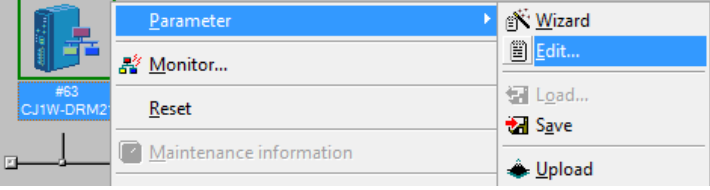
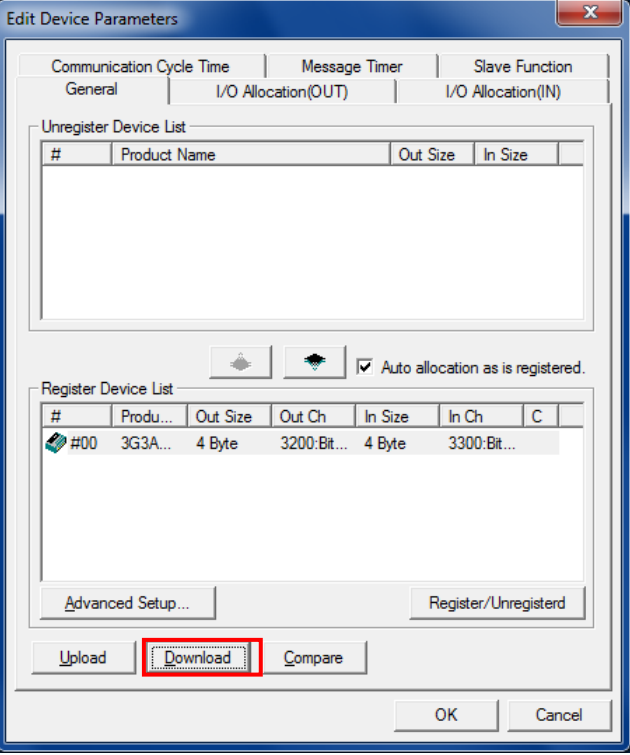
- 4 Right-click *DeviceNet* in the Online Connection Information Window, and select **Connect**.
- 
- 5 Select DeviceNet in the Select Network Dialog Box, and click the **OK** Button.
- 
- 6 Confirm that the DeviceNet is in online status ( icon) in the Online Connection Information Window.
- 
- 7 Right-click CJ1W-DRM21 on the Network Configuration Window, and select **Parameter - Edit**.
- 
- 8 The Edit Device Parameters Dialog Box is displayed. Click the **Download** Button.
- 

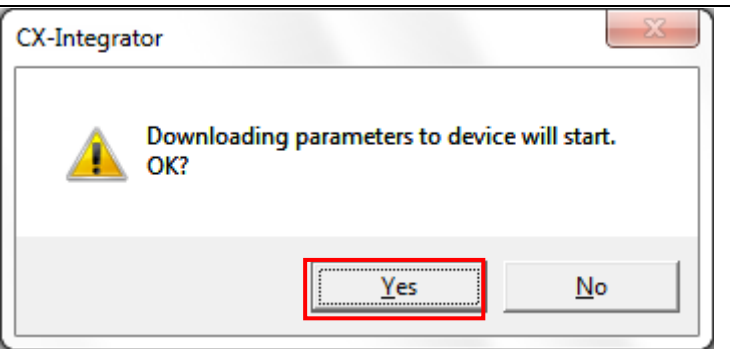
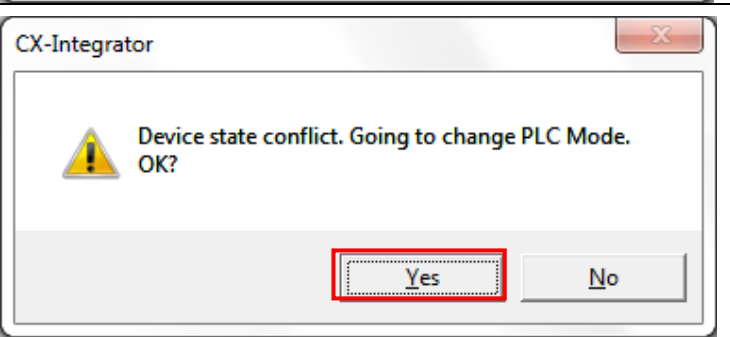
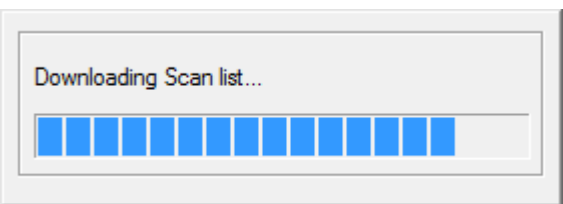
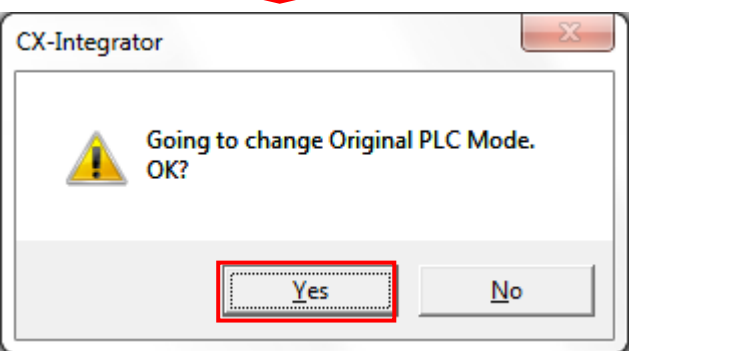
<p>9 A download confirmation dialog box is displayed. Click the Yes Button to download the parameters.</p>	
<p>10 A dialog box is displayed confirming whether to change the mode. Click the Yes Button.</p> <p>A dialog box is displayed indicating downloading is being performed.</p> <p>When downloading is completed, a dialog box is displayed confirming whether to change the mode. Click the Yes Button.</p>	 <p style="text-align: center;">↓</p>  <p style="text-align: center;">↓</p> 

11 The Edit Device Parameters Dialog Box is displayed again. Click the **Compare** Button.

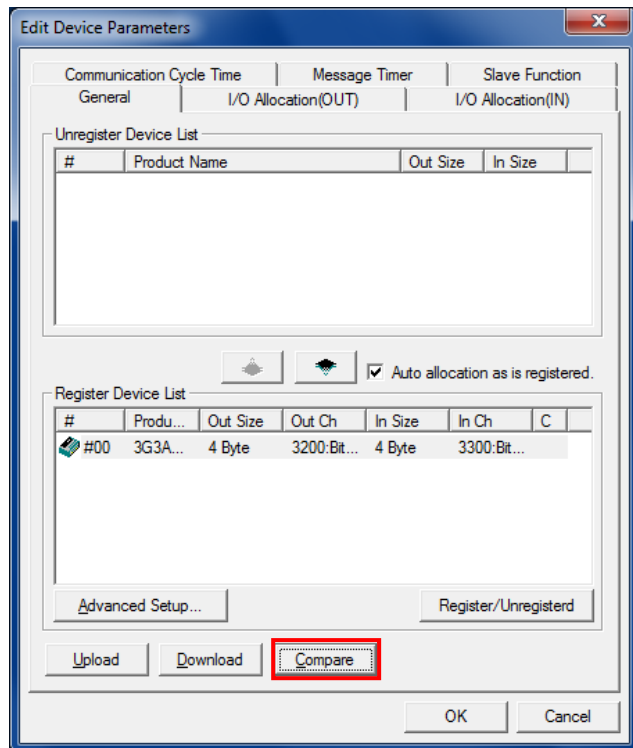

12 A dialog box shown on the right is displayed. Click the **Yes** Button to compare the parameters.

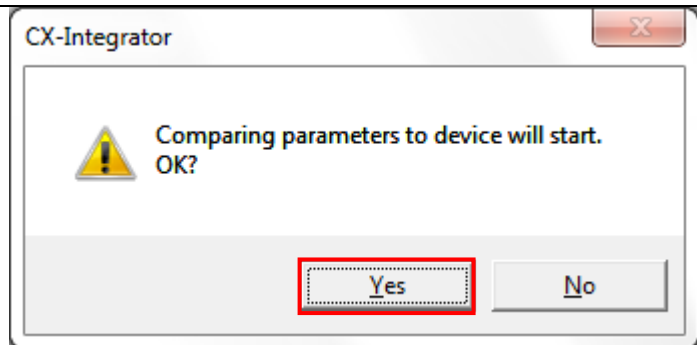

When the comparison is completed, a dialog box shown on the right is displayed. Click the **OK** Button.

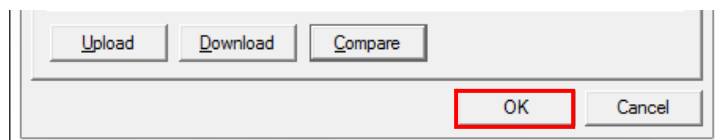
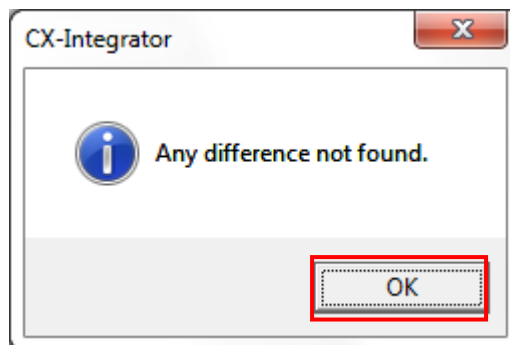

The Edit Device Parameters Dialog Box is displayed again. Click the **OK** Button.

11. Revision History

Revision code	Date of revision	Revision reason and revision page
01	Mar. 5, 2013	First edition

OMRON Corporation Industrial Automation Company

Tokyo, JAPAN

Contact: www.ia.omron.com

Regional Headquarters

OMRON EUROPE B.V.

Wegalaan 67-69-2132 JD Hoofddorp
The Netherlands

Tel: (31)2356-81-300/Fax: (31)2356-81-388

OMRON ELECTRONICS LLC

One Commerce Drive Schaumburg,
IL 60173-5302 U.S.A.

Tel: (1) 847-843-7900/Fax: (1) 847-843-7787

OMRON ASIA PACIFIC PTE. LTD.

No. 438A Alexandra Road # 05-05/08 (Lobby 2),
Alexandra Technopark,
Singapore 119967

Tel: (65) 6835-3011/Fax: (65) 6835-2711

OMRON (CHINA) CO., LTD.

Room 2211, Bank of China Tower,
200 Yin Cheng Zhong Road,
PuDong New Area, Shanghai, 200120, China

Tel: (86) 21-5037-2222/Fax: (86) 21-5037-2200

Authorized Distributor:

© OMRON Corporation 2013 All Rights Reserved.
In the interest of product improvement,
specifications are subject to change without notice.

Cat. No. P546-E1-01

0911(-)