

NEW

OMRON

N-Smart

Sensor Communications Unit
Distributed Sensor Unit
E3NW

Revolutionize the Workplace

Introducing the Next-generation E3NW Sensor Networking Units

Introduction	Commissioning	Operation
Lower Costs	Less Time	Higher Productivity



Sensor Communications Unit
E3NW-ECT

Distributed Sensor Unit
E3NW-DS

**BEST
PRICE**

realizing

EtherCAT

From Introduction to Commissioning and Operation

Revolutionize the Workplace

The Next-generation Sensor Networking Units

E3NW

A new Distributed Sensor Unit appears as a slave to the Sensor Communications Unit master. Use these two next-generation Sensor Networking Units to connect distributed N-Smart Sensors to an open-network controller. Implementing a Sensor Network solves many workplace issues from introduction to commissioning and operation.



*1. The DS-Bus is an OMRON inter-Unit network communications protocol, that connects the E3NW-ECT Sensor Communications Unit and E3NW-DS Distributed Sensor Units.

Point



Industry's Fastest ^{*2} Reading Time for Present Values

Ideal for high-speed workpieces and high-precision position feedback control.

Ultra-high speed, such as 0.2 ms for I/O data between the Sensor Amplifier Units and Sensor Communications Unit, 1 ms for present value data. A network also allows you to easily control applications that previously required Analog Units. At 5 ms, high speed is also provided between the Distributed Sensor Units and Sensor Communications Unit.

*2. As of February 2013. According to OMRON investigation.

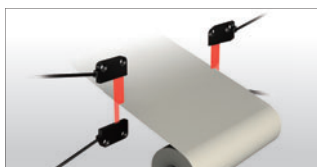

Detecting Snaking in Wrapping Sheets

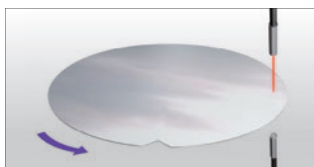

Detecting Wafer Notch Positions

I/O data: **0.2 ms**
Present value data: **1 ms**



I/O data and present value data: **5ms**



Radically Reduce Manufacturing Costs

Even if you implement a Sensor Network, the cost of introduction is greatly reduced.

Previously (without a Sensor Network)

Equipment cost + Wiring cost and wiring work +
Wiring check + Possible reconnection for wiring mistakes

Reconnection for Wiring Mistakes

Wiring check

Wiring cost and work

Input Unit:
16 inputs

Analog Input Unit:
1 input

Fiber Amplifier Units: 2

Laser Amplifier Unit: 1

*Distributed to five locations.

If three Amplifier Units are connected to each other and distributed to five different locations, 25 cables are required. Wiring check is also difficult.

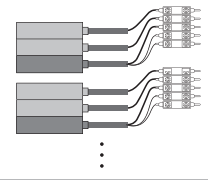

Equipment cost

*Ten Fiber Amplifier Units and five Laser Amplifier Units are distributed, with three Amplifier Units each to five locations.

Equipment cost, wiring cost, and wiring time are all required for distributed placement. If any wiring mistakes occur, the Amplifier Units must be checked individually, resulting in a high construction cost.

With the E3NW

Large reduction in equipment cost
+ **Reduced wiring and reduced work**

No Amplifier Unit Wiring

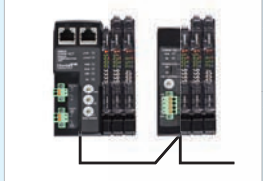

*Wiring is required between the Sensor Communications Unit and Distributed Sensor Units (two power supply lines and two output lines).

E3NW-ECT Sensor Communications Unit: 1

E3NW-DS Distributed Sensor Units: 4

Fiber Amplifier Units: 2

Laser Amplifier Unit: 1

*Distributed to five locations.

Equipment cost

*Ten Fiber Amplifier Units and five Laser Amplifiers are distributed, with three Amplifier Units each to five locations.

Implementing a network is possible with the current distributed placement without increasing the cost. There is less wiring so wiring cost and work are also reduced. Commissioning systems overseas and reconnection by the user are both easier.

Greatly Reduce Introduction Cost in Comparison to Previous Sensor Networks

Previous Sensor Networks

Previous Sensor Communications Units: 5

Fiber Amplifier Units: 2

Laser Amplifier Unit: 1

*Distributed to five locations.

Equipment cost

*Ten Fiber Amplifier Units and five Laser Amplifiers are distributed, with three Amplifier Units each to five locations.

Distributed placement is used for the Sensor Amplifier Units, so a Sensor Communications Unit is required in each location. Previous Sensor Communications Units were expensive, which drove up equipment costs.

With the E3NW

Large reduction in equipment cost

E3NW-ECT Sensor Communications Unit: 1

E3NW-DS Distributed Sensor Units: 4

Fiber Amplifier Units: 2

Laser Amplifier Unit: 1

*Distributed to five locations.

Equipment cost

*Ten Fiber Amplifier Units and five Laser Amplifiers are distributed, with three Amplifier Units each to five locations.

The cost makes Sensor Communications Unit introduction easier than for previous Units. And the release of the reasonably priced Distributed Sensor Unit means the cost of new introduction is greatly reduced even more.

Radically Reduce System Commissioning Time

Easy Batch Setting from a Touch Panel

Previously (without a Sensor Network)

When Sensor Amplifier Units must be distributed to narrow locations, the Units had to be set individually, creating extensive work and requiring time to make the settings.

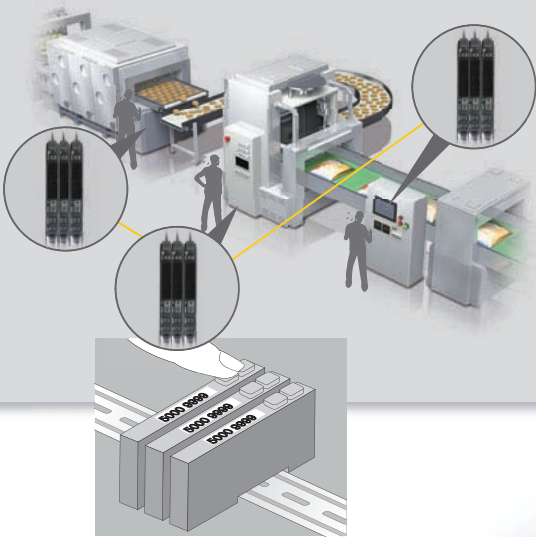

With the E3NW

Even if the Sensors are distributed, you can set all of them from a touch panel. It's easy and quick to set all of them from the same location.

Press the button for the Amplifier Unit to set.

Initial Display

Settings Display

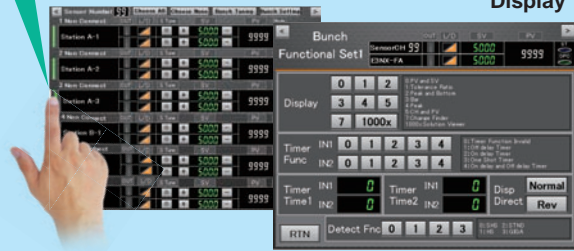

*The displays are conceptual illustrations.

Line Changeovers Are Also Easy with a Setup Backup Function

Previously (without a Sensor Network)

The Sensor Amplifier Units must be set whenever the workpiece changes. Sometimes adjustments are difficult and the setup is time consuming, which can reduce productivity.



With the E3NW

The setup data is saved in the Controller. If the workpiece changes, just select the correct setup. This also makes Amplifier Unit replacement easier and more reliable should it ever be necessary.

Function Settings Display

Setup Selection Display



*The displays are conceptual illustrations.

Radically Increase Machine Productivity

Monitoring for Predictive Maintenance

Previously (without a Sensor Network)

In harsh environments, Sensors can become dirty, resulting in malfunctions.

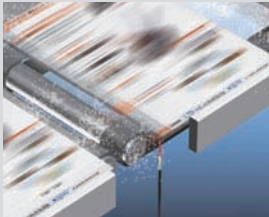

Detection in Dusty Environment

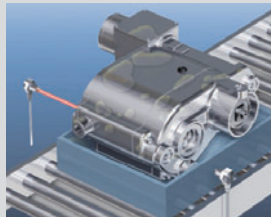

Detection in Oily Environment

With the E3NW

If Sensor status is monitored in realtime, maintenance is possible before the Sensor malfunctions.

Initial Display



Trend Graph

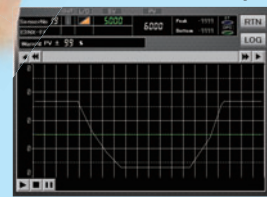

*The displays are conceptual illustrations.



You can use E3NW communications to create controller programming or touch panel displays to perform all of the settings and monitoring that are described on pages 4 and 5. Display samples for OMRON NS-series Programmable Terminals (touch panels) and sample programming for OMRON NJ-series Controllers are available. For details, please contact your OMRON sales representative.

Reduced Downtime When Troubles Occur

Previously (without a Sensor Network)

If the equipment stopped due to a problem with a Sensor, time was required to isolate the Sensor where the problem occurred and find the cause.



With the E3NW

You can immediately find the location, the Sensor, and the type of error to quickly recover normal operation and reduce downtime.

Initial Display for Errors



*The displays are conceptual illustrations.

Ordering Information

Sensor Communications Unit

Communications method and Unit appearance	Model
EtherCAT 	E3NW-ECT

CompoNet-compatible and CC-Link-compatible products are also available. Refer to your OMRON website for details.

Distributed Sensor Unit

Appearance	Model
	E3NW-DS

Connectable Sensor Amplifier Units

Type	Model
Smart Fiber Amplifier Unit	E3NX-FA0
Smart Laser Amplifier Unit	E3NC-LA0
Smart Laser Amplifier Unit (CMOS type)	E3NC-SA0
Contact-Type Smart Amplifier Unit	E9NC-TA0

Ratings and Specifications

Item	Type Model	Sensor Communications Unit	Distributed Sensor Unit
		E3NW-ECT	E3NW-DS
Connectable Sensor Amplifier Units		N-Smart Smart Fiber Amplifier Unit: E3NX-FA0 Smart Laser Amplifier Unit: E3NC-LA0 Smart Laser Amplifier Unit (CMOS type): E3NC-SA0 Contact-Type Smart Amplifier Unit: E9NC-TA0 *1	
Power supply voltage		24 VDC (20.4 to 26.4 V)	
Power and current consumption		2.4 W max. (Not including the power supplied to Sensors.), 100 mA max. (Not including the current supplied to Sensors.)	2 W max. (Not including the power supplied to Sensors.), 80 mA max. (Not including the current supplied to Sensors.)
Indicators		L/A IN indicator (green), L/A OUT indicator (green), PWR indicator (green), RUN indicator (green), ERROR indicator (red), and SS (Sensor Status) indicator (green/red)	RUN indicator (green) and SS (Sensor Status) indicator (green/red)
Vibration resistance (destruction)		10 to 60 Hz with a 0.7-mm double amplitude, 50 m/s ² at 60 to 150 Hz, for 1.5 hours each in X, Y, and Z directions	
Shock resistance (destruction)		150 m/s ² for 3 times each in X, Y, and Z directions	
Ambient temperature range		Operating: 0 to 55°C; *2 Storage: -30 to 70°C (with no icing or condensation)	
Ambient humidity range		Operating and storage: 25% to 85% (with no condensation)	
Maximum connectable Sensors		30 *3	10
Maximum connectable Distributed Sensor Units		8	-
Insulation resistance		20 MΩ min. (at 500 VDC)	
Dielectric strength		500 VAC at 50/60 Hz for 1 minute	
Mounting method		35-mm DIN track - mounting	
Weight (packed state/Unit only)		Approx. 185 g/approx. 95 g	Approx. 160 g/approx. 40 g
Materials		Polycarbonate	
Accessories		Power supply connector, communications connectors, connector cover, DIN Track End Plates, and Instruction Manual	Power supply/communications connector, connector cover, DIN Track End Plates, ferrite core, and Instruction Manual

*1. The E9NC-TA0 is supported for firmware version 1.03 or higher (Sensor Communications Units manufactured in July 2014 or later).

*2. Temperature Limitations Based on Number of Connected Amplifier Units:

Groups of 1 or 2 Amplifier Units: 0 to 55°C, Groups of 3 to 10 Amplifier Units: 0 to 50°C, Groups of 11 to 16 Amplifier Units: 0 to 45°C, Groups of 17 to 30 Amplifier Units: 0 to 40°C

*3. You can connect up to 30 Sensors total to the Sensor Communications Unit and Distributed Sensor Units.

Communications Specifications

Item	Specification
Communication protocol	Dedicated protocol for EtherCAT
Modulation	Base band
Baud rate	100 Mbps
Physical layer	100BASE-TX (IEEE 802.3u)
Topology	Daisy chain
Communications media	STP category 5 or higher
Communications distance	Distance between nodes: 100 m max.
Noise resistance	Conforms to IEC 61000-4-4, 1 kV or higher
Node address setting method	Set with decimal rotary switches or software*1
Node address range	000 to 192*2

*1. The software setting is used when the node address setting switches are set to 0.

*2. The range depends on the EtherCAT master that is used. Refer to the *E3NW-ECT EtherCAT Sensor Communications Unit Operation Manual* for details.

Dimensions

(Unit: mm)
Tolerance class IT16 applies to dimensions in this data sheet unless otherwise specified.

Sensor Communications Unit E3NW-ECT

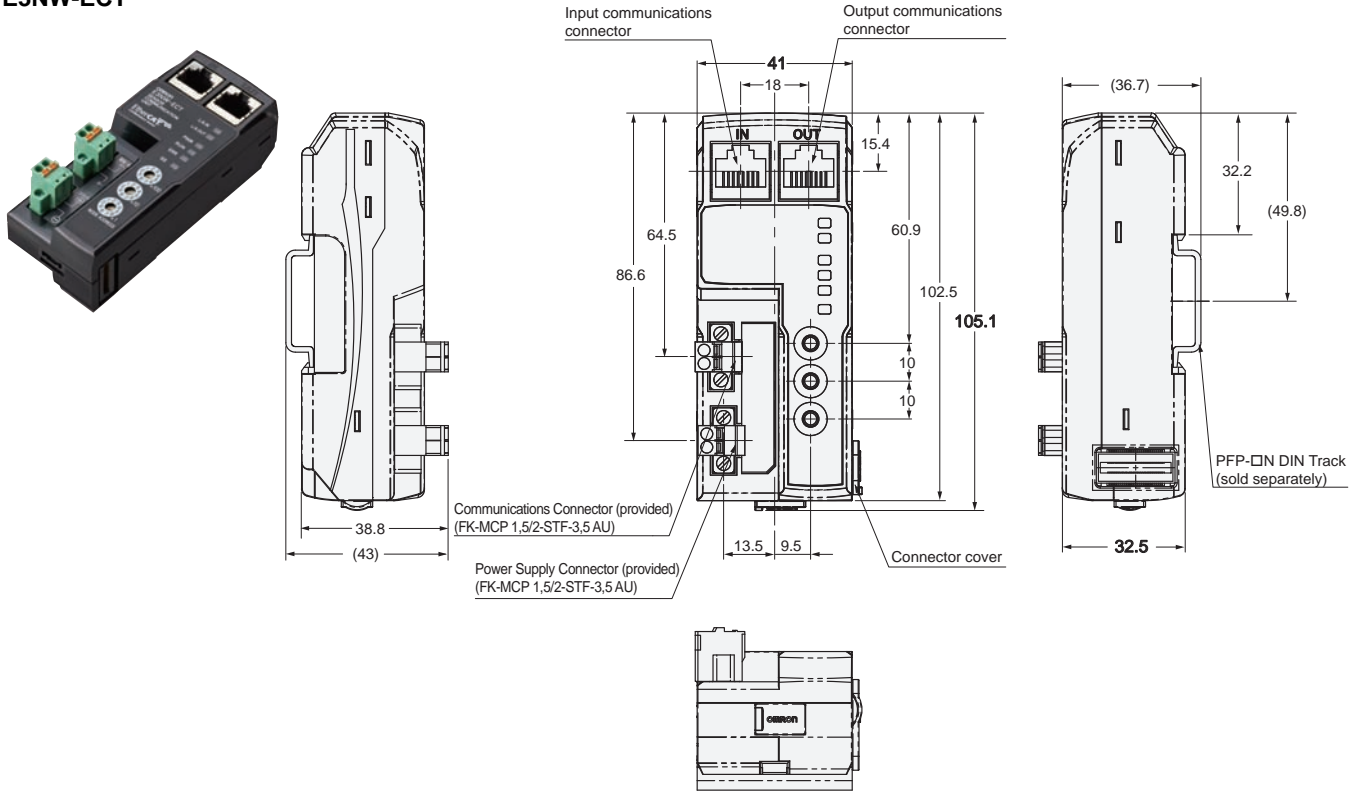

Distributed Sensor Unit E3NW-DS

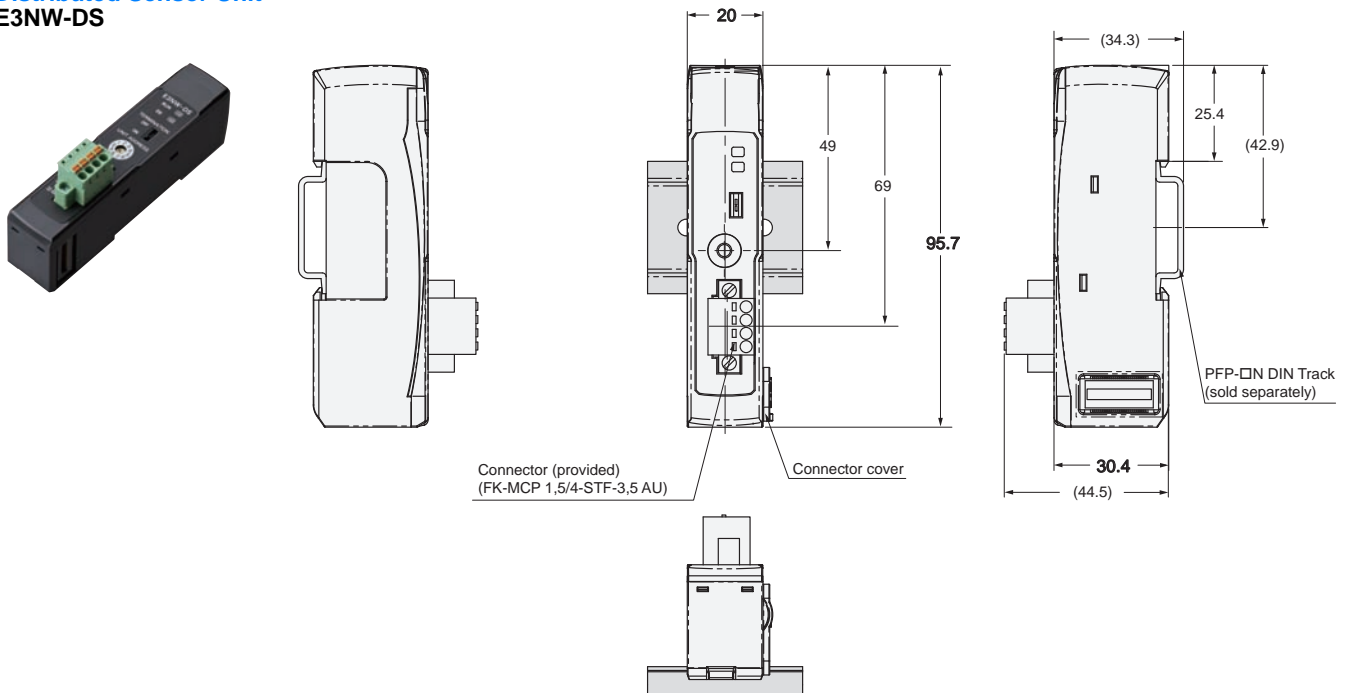

The N-Smart Lineup

E3NX-FA
Fiber Amplifier Units
Cat. No. E426

N-Smart Amplifier Units
Easy application with consistent operating procedures.

E3NC-S
Ultra-compact CMOS Laser Sensors
Cat. No. E427

E3NC-L
Compact Laser Sensors
Cat. No. E427

E3NW
Sensor Communications Units

N-Smart
Presence Detection Measurement

Applications with Many Sensors:
More convenience and even lower costs with a network.

EtherCAT
CompoNet
CC-Link V2

Fiber Amplifier Units and Laser Sensors

- A New Level of Detection Performance for More-stable Equipment Operation

Smart Fiber Amplifier Units
E3NX-FA

Cat.No.E426



- Select the Best Laser Sensor at the Best Price for Your Application

Smart Laser Sensors
E3NC-L/E3NC-S

Cat.No.E427



EtherCAT® is a registered trademark and patented technology, licensed by Beckhoff Automation GmbH, Germany.

CompoNet is a registered trademark of the ODVA.

CC-Link is a registered trademark of Mitsubishi Electric Corporation.

The trademark is managed by the CC-Link Partner Association.

OMRON Corporation Industrial Automation Company
Tokyo, JAPAN

Contact: www.ia.omron.com

Regional Headquarters

OMRON EUROPE B.V.
Sensor Business Unit
Carl-Benz-Str. 4, D-71154 Nufringen, Germany
Tel: (49) 7032-811-0/Fax: (49) 7032-811-199

OMRON ELECTRONICS LLC
One Commerce Drive Schaumburg,
IL 60173-5302 U.S.A.
Tel: (1) 847-843-7900/Fax: (1) 847-843-7787

OMRON ASIA PACIFIC PTE. LTD.
No. 438A Alexandra Road # 05-05/08 (Lobby 2),
Alexandra Technopark,
Singapore 119967
Tel: (65) 6835-3011/Fax: (65) 6835-2711

OMRON (CHINA) CO., LTD.
Room 2211, Bank of China Tower,
200 Yin Cheng Zhong Road,
PuDong New Area, Shanghai, 200120, China
Tel: (86) 21-5037-2222/Fax: (86) 21-5037-2200

Authorized Distributor:

© OMRON Corporation 2013 All Rights Reserved.
In the interest of product improvement,
specifications are subject to change without notice.

CSM_3_1_0714
Cat. No. E428-E1-01

Printed in Japan
0213 (0213) (W)